

USG
Ceiling
Solutions

LOGIX™
Integrated Ceiling Systems

SYSTEMS GUIDE

USG
IT'S YOUR WORLD. BUILD IT.™

SYSTEMS GUIDE

Logix™ Brand Integrated Ceiling Systems from USG allow you to design ceilings that meet building requirements without being constrained by the limits of traditional acoustical ceilings. Logix transforms visual distractions such as lighting, air vents, and other utilities into dramatic design elements by concentrating these fixtures on narrow channels. This allows for open ceilings that are uncluttered by ceiling utilities and offer a clean, monolithic, custom look with standard components.

Logix is compatible with a wide selection of 4 in., 6 in., and 12 in. luminaires and utilities, as well as 100 mm, 150 mm 300 mm luminaires and utilities.

		Page
Logix Integrated Ceiling Systems	Overview	2
	Reflected Ceiling Plan	
	Definitions	
Plan Your System	Options	12
	Connector Panels	
	Logix Yoke	
Design Considerations	Layout Options	19
	Drywall Ceilings	
	Chilled Beams	
Select Your System	On-Module Channel Spacing	28
	Off-Module Channel Spacing	
	Metric Systems	142
For More Information	Technical Service 800 USG.4YOU	Website usg.com

LOGIX INTEGRATED CEILING SYSTEMS

Overview

A wide selection of acoustical and specialty panels as well as corresponding suspension system profiles are available to enhance and customize your design. Plus, with a wide selection of Logix partners, you can be assured that ceiling utilities will complement your design and integrate seamlessly into the ceiling.

Office Space



LOGIX INTEGRATED CEILING SYSTEMS

Overview

Transform lighting, ventilation, and other utilities from visual distractions to dramatic design elements by concentrating these fixtures on narrow bands running the length of a ceiling. Suddenly, the ceiling is neat and orderly, allowing wide-open spaces uninterrupted by mechanical components.

Lobby



LOGIX INTEGRATED CEILING SYSTEMS

Overview

Accentuate vertical elements and create a custom look without the custom cost while using standard products, panels, and components. Positioning channels between main tees allows you to enliven your design with continuous, uninterrupted, decorative, and functional channels.

Airport



LOGIX INTEGRATED CEILING SYSTEMS

Reflected Ceiling Plan

Example Reflected Ceiling Plan (RCP) Layout

- ① Utility Channel
- ② Opening for Luminaire, Mechanical Grille, or Other Utility
- ③ Channel Panel
- ④ Infill Panel
- ⑤ Connector Panel
- ⑥ Yoke
- ⑦ Accessible Stabilizer Bar¹
- ⑧ Channel-to-Channel Module Unit

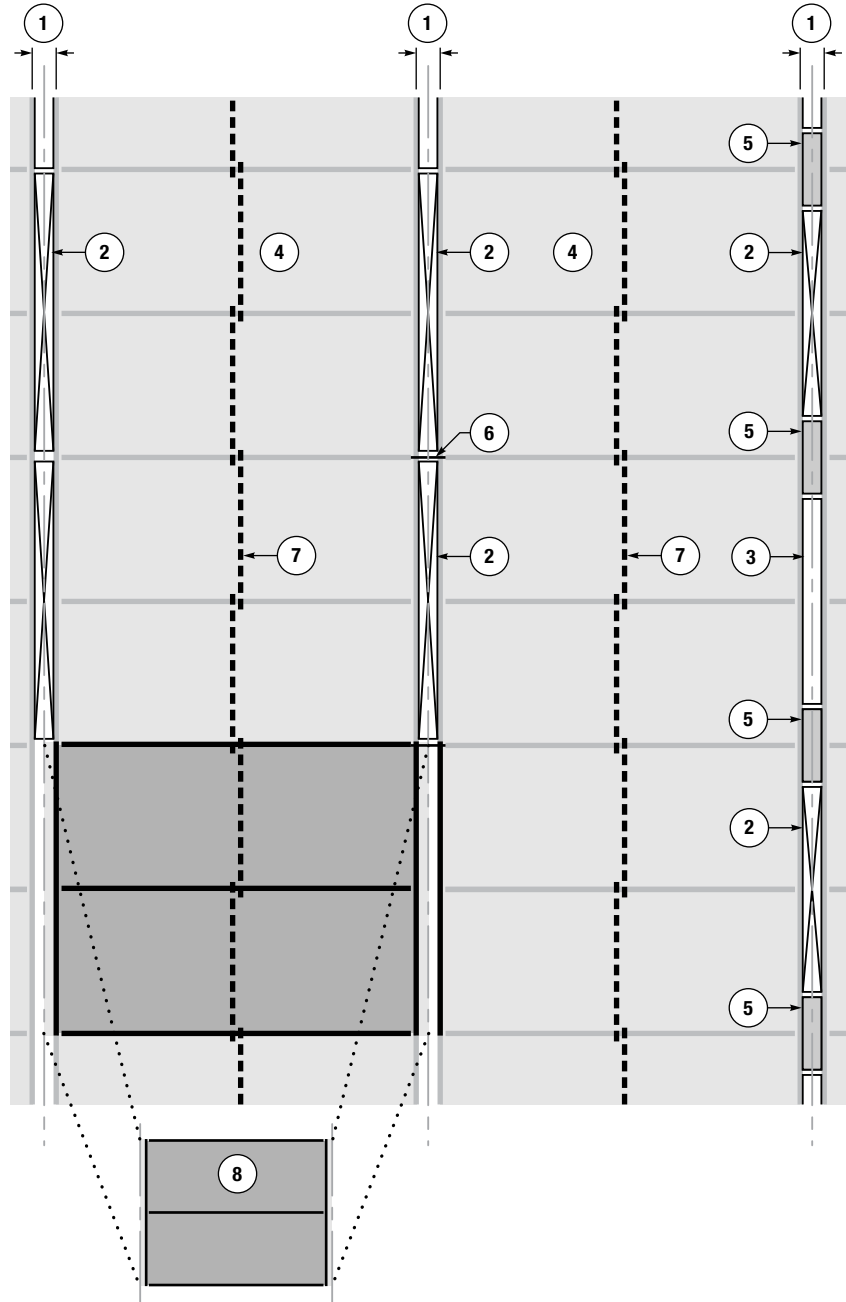

¹ Stabilizer bar required if opening $\geq 60''$. For more information about stabilizer bars, please refer to Plank and Large Panel Stabilizer Bars — Application Guide, IC592.

LOGIX INTEGRATED CEILING SYSTEMS

Definitions

Module The module is the measurement basis for coordinating the dimensions of the various suspended ceiling materials and layouts to be designed and constructed.

There are two key module measurements in a Logix ceiling system:

Channel Module The measurement from the centerline of two adjacent utility channels, also referred to as channel-to-channel spacing

Ceiling Module The measurement from the centerline of the suspension system tees installed perpendicular to the utility channels

Module Measurements

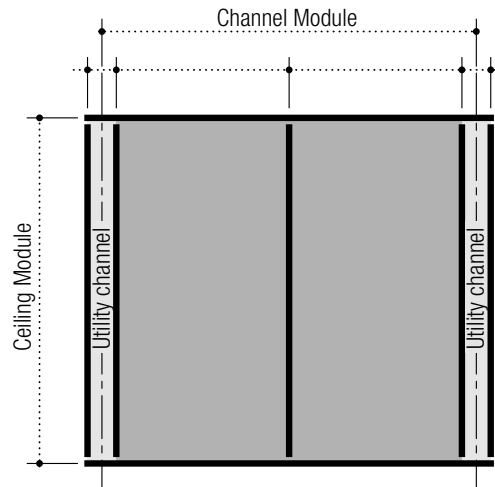

LOGIX INTEGRATED CEILING SYSTEMS

Definitions

Utility Channel

Utility channels are used to organize the lighting, ventilation, and other utilities in narrow bands that facilitate dramatic design elements that are versatile and functional. These narrow suspended ceiling channels are created by main tees or cross tees. The length of utility channels can vary allowing the freedom of various infill layout options.

Imperial 4 in., 6 in., and 12 in.

Utility Channels

Metric 100 mm, 150 mm, and 300 mm

Utility Channels

Configurations

There are four types of configurations used to design a utility channel.

Continuous utility channels are uninterrupted by tees. This is created by *main tees* that frame the channel.

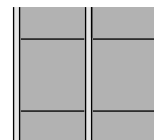

Fixed utility channels have intersecting tees. This is created by *cross tees* that frame the channel.

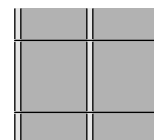

Separated utility channels are *non-continuous*.

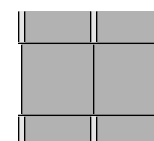

Crosscut utility channels have *intersecting* channels.

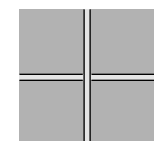

Other Ceiling Mounted Devices

- Air diffusers
- Cameras
- Smoke detectors
- Sprinkler systems
- Fire alarms
- Speakers
- Lighting fixtures

LOGIX INTEGRATED CEILING SYSTEMS

Definitions

Panels

A variety of panel options are available to design a Logix ceiling system. There are three types of panels.

Channel Panel

Channel panels are narrow acoustical or metal ceiling panels used in utility channels. Channel panels can be installed in a continuous manner creating a monolithic and uninterrupted aesthetic or in conjunction with lighting, ventilation and other utilities.

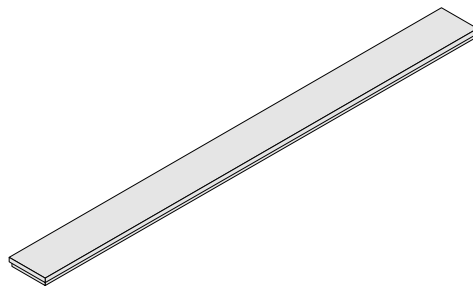

Infill Panel

Infill panels are larger acoustical or metal ceiling panels installed in the space between utility channels.

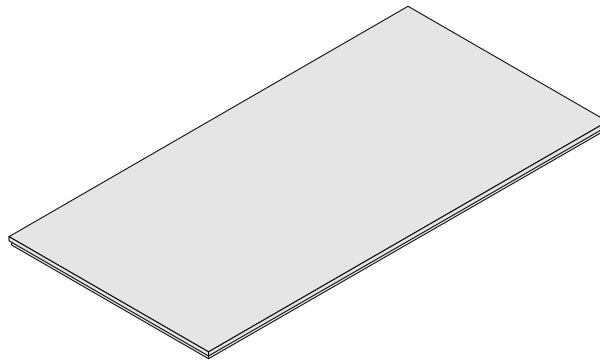

Connector Panel

Connector panels are a unique option for USG Logix ceiling systems. Connector panels visually connect various utilities in a utility channel such as luminaires and channel panels. Connector panels are configured to carry the adjacent panel or fixture. No special fixture types or tile edges are needed. Connector panels are metal and available in perforated and smooth finishes. Imperial and metric sizes are available.

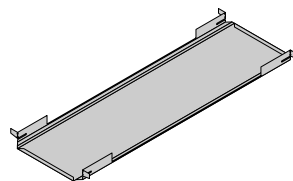

LOGIX INTEGRATED CEILING SYSTEMS

Definitions

Module Unit A module unit is a representative section of the ceiling system consisting of two utility channels and the adjoining infill panels. Module units can be used to estimate the materials needed to install a ceiling assembly. There are two types of module units.

Off-Module Unit Off-Module units represent assemblies where *typical* ceiling panel sizes are utilized between the utility channels. With the addition of the utility channel, this creates off-module or *nonstandard* channel module (channel-to-channel) spacing.

52" Channel Module

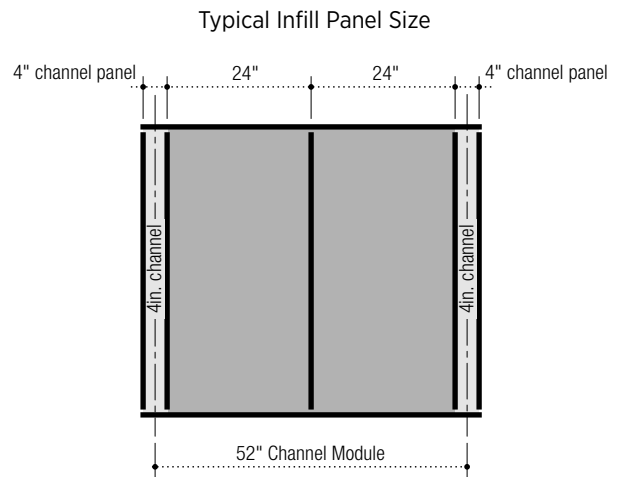

On-Module Unit On-Module units represent assemblies where *atypical* ceiling panel sizes are utilized between the utility channels. With the addition of the utility channel, this creates on-module or a *standard* channel module (channel-to-channel) spacing.

48" Channel Module

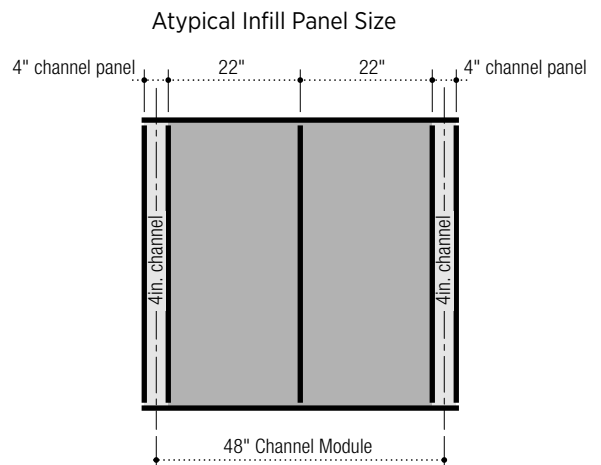

For further module unit options, see page 20.

LOGIX INTEGRATED CEILING SYSTEMS

Definitions

Suspension Systems

There are three types of grid suspension systems used in a Logix system.

Donn® DX®/DXL™
Standard

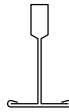

Centricitee™ DXT™
Narrow



Identitee™ DXI™
Double Reveal



Main Tee Utility Channel

A utility channel created with *main tees* that frame that channel. This type of channel is used in a continuous utility channel configuration.

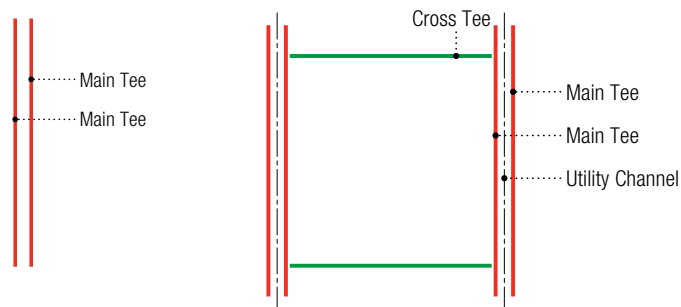

Cross Tee Utility Channel

A utility channel created with *cross tees* that frame the channel. This type of channel is used in a fixed, separated, or crosscut utility channel configuration.

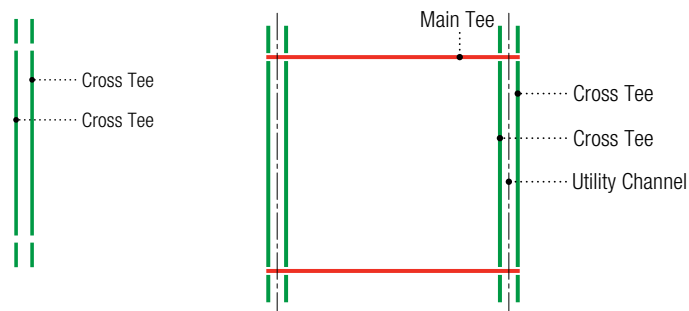

See layout details on page 19.

LOGIX INTEGRATED CEILING SYSTEMS

Definitions

Yoke

The USG Logix Yoke is an optional suspension system installation accessory that facilitates the spacing and suspension of parallel main tees with one hanger wire. The Logix yoke is compatible with both metric and imperial utility channel sizes. The yoke also keeps hanger wire wraps away from linear luminaires and can reduce the number of hanger wires required. The yoke also helps to brace the utility channel.

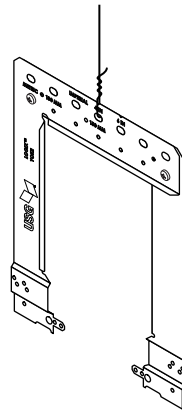

See layout details and assemblies on pages 17-18.

Accessible Stabilizer Bar





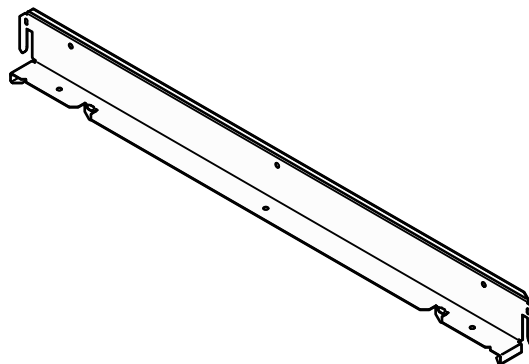





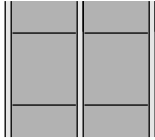
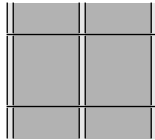
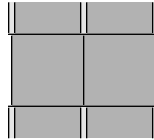
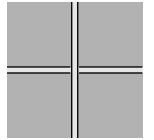
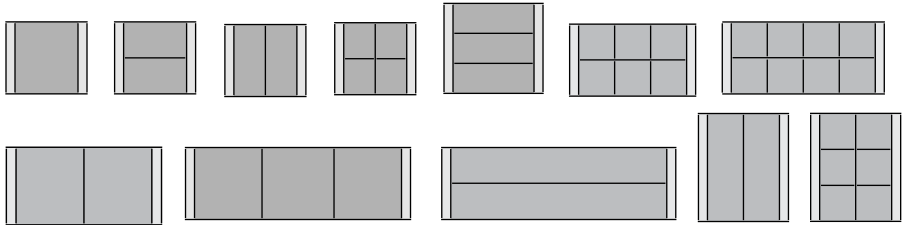





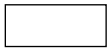
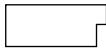
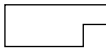
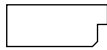



The USG Accessible Stabilizer Bar is a suspension system installation accessory used in plank and large panel suspension systems. Specially notched safety bars attach to the main tees and cross tees, which prevents the tee ends from spreading and enhances the rigidity of large ceiling modules.

USG stabilizer bars are available in different sizes and options for various applications. If the panel length is ≥ 60 in., then one stabilizer is required at midpoint. If the panel length is ≥ 96 in., then two stabilizer bars are required at the $1/3$ and $2/3$ points. These safety bars enhance system performance and safety without limiting accessibility.

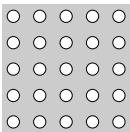

PLAN YOUR SYSTEM

Selector Options

1 Utility Channel Configuration	Continuous 	Fixed 	Separated 	Crosscut 	
2 Utility Channel Width	Imperial 4", 6", 12"	Metric 100 mm, 150 mm, 300 mm		Custom Contact your Sales Representative for custom options.	
3 Channel Module Spacing (Channel-to-Channel)	4' 5' 6' 7' 8'-6"	4'-4" 5'-4" 6'-6" 7'-6" 10'-6"	4'-6" 5'-6" 12'	1200 mm 1500 mm 1300 mm 1900 mm 1350 mm 1950 mm	
4 Ceiling Module Dimension	4', 5', 6' ceiling module		1.25 m, 1.5 m, 1.75 m ceiling module		
					
5 Infill Panel Specification	Mars™ 	Mars™ High-NRC 	Halcyon™ 	Panz® Metal 	True™ Wood 
6 Infill Panel Edge Profile	Square 	FL 	SL 	FLB 	SLT 
7 Grid Profile	DXI Identitee 	DXT Centricitee 	Donn DX 		
8 Channel Panel Specification	Mars 	Mars High-NRC 	Halcyon 	Panz Metal 	
9 Channel Panel Edge Profile	Square 	FL 	SL 	FLB 	SLT 

PLAN YOUR SYSTEM

Utility Channel Options

Imperial

4" Channel

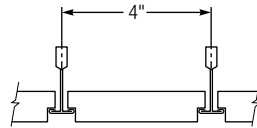

6" Channel

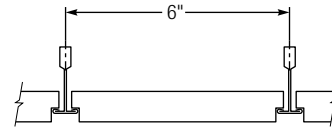

12" Channel

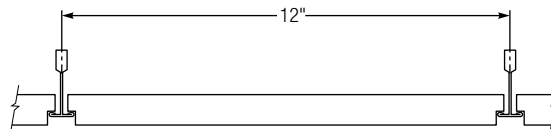

Metric

100 mm Channel

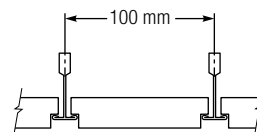

150 mm Channel

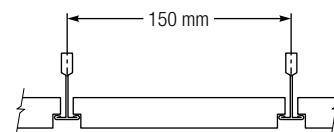

300 mm Channel

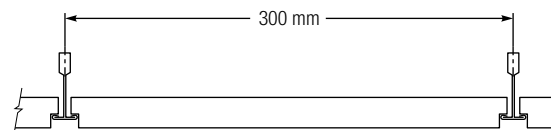

PLAN YOUR SYSTEM

Panel Options

The panel options listed below correspond to our standard fixed ceiling modules. However, virtually all standard ceiling panels are possible with a continuous utility channel system. Contact your sales representative for more information.

Infill Panel Options

Halcyon™ Fiberglass



Mars™ X-Technology Mineral Fiber



Mars™ High-NRC X-Technology Mineral Fiber



Panz® Unperforated Metal Aluminum

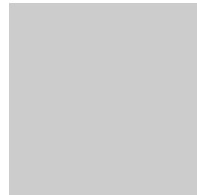

Panz® Wood Tone Metal



True™ Wood Natural Wood Veneers



Channel Panel Options

Halcyon™ Fiberglass



Mars™ X-Technology Mineral Fiber



Mars™ High-NRC X-Technology Mineral Fiber



Panz® Unperforated Metal Aluminum

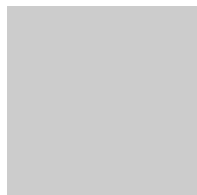

Panz® Perforated, C116 Aluminum

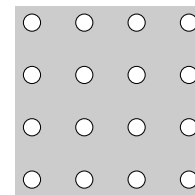

Panz® Perforated, C116D Aluminum

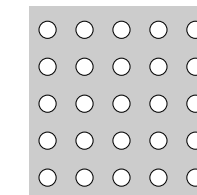











Panz® Wood Tone Metal

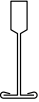
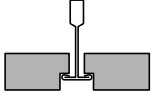
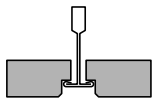
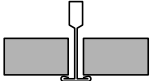
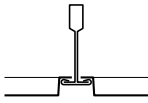
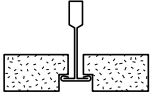

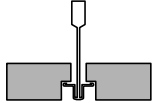
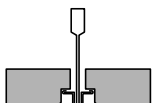
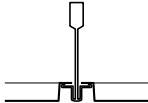
PLAN YOUR SYSTEM

Suspension System Options

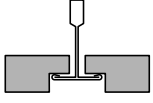
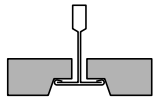
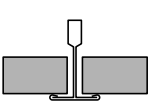
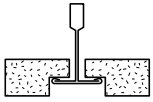

		Panel Edge Options				
		FL	FLB	SL	SLT	SQ
Suspension Systems						
	Centricitee™ DXT™ 					Maximum 2' x 2' SQ Edge panels with DXT. 
	Panz® Metal					
	True™ Wood					
Identitee™ DXI™						
	Identitee DXI suspension icon					
	Panz Metal					
Donn® DX®/DXL™						
	Donn DX/DXL suspension icon					
	True™ Wood					

PLAN YOUR SYSTEM

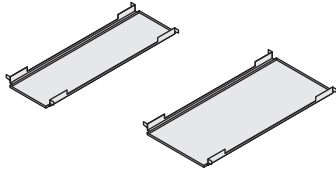
Connector Panels

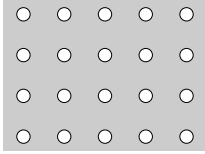
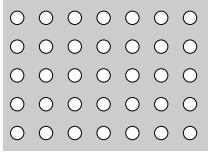

The Logix connector panel is a unique way to visually connect various utilities such as luminaires and channel panels. The connector panels are configured to carry the adjacent panel or fixture. No special fixture types or tile edges are needed.

Options	Finish	Smooth, Unperforated	Perforated, C116	Perforated, C116D	
					
	Color	Flat White Painted			
	Edge Profile	Reveal Edge 		Flush Mount 	
		4" Channel Imperial 4" x 12" 4" x 24"		6" Channel Imperial 6" x 12" 6" x 24"	
		100 mm Channel Metric 100 mm x 300 mm 100 mm x 600 mm		150 mm Channel Metric 1500 mm x 300mm 1500 mm x 600 mm	

PLAN YOUR SYSTEM

Logix Yoke

The Logix yoke is compatible with both metric and imperial utility channel sizes. The yoke keeps hanger wire wraps away from linear luminaires and may reduce the number of hanger wires required. The yoke also helps to brace the utility channel. The yoke is easy to install and is seismic tested.

Note: The USG yoke provides connections that exceed the 180 lb. requirement for Seismic Design Categories D-F.

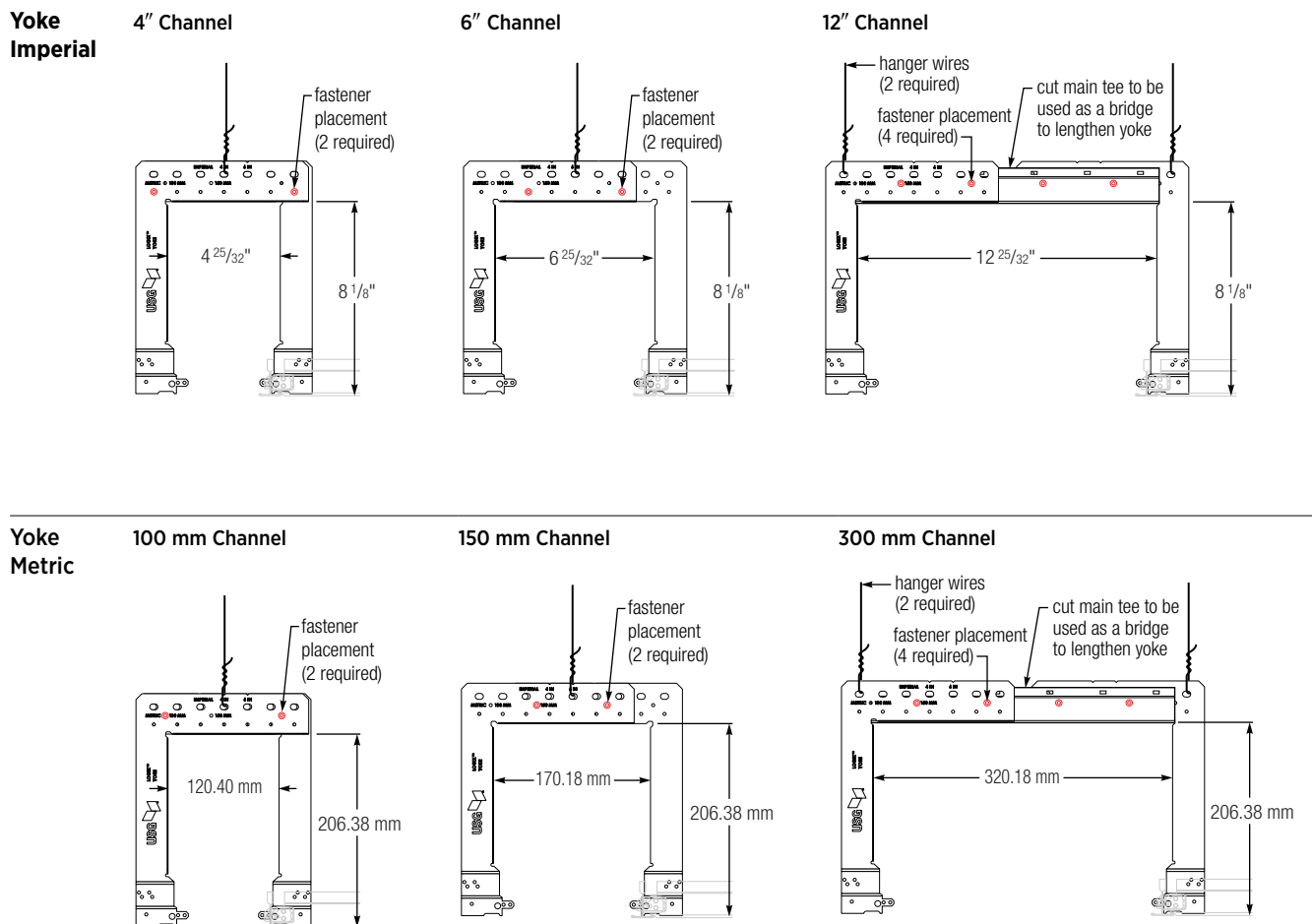

PLAN YOUR SYSTEM

Yoke Assemblies

Yoke with Connector Panel

The Logix yoke is compatible with all utility channel options and applications. The connector panel shown is one of many options allowing the freedom to transform the utilities into dramatic design elements.

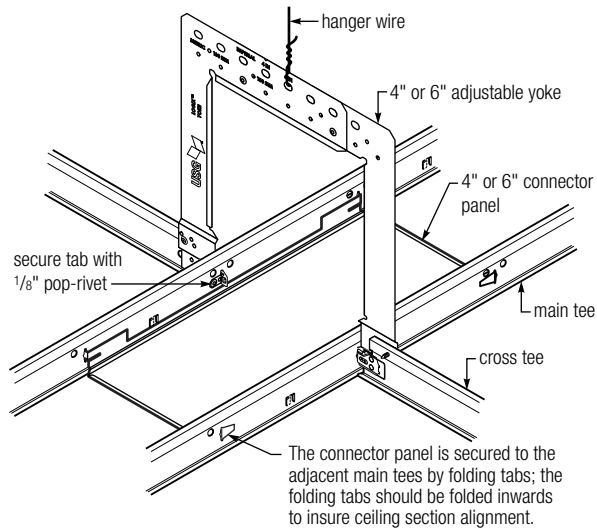

Yoke with Recessed Linear Luminaires

Logix is compatible with a wide selection of 4", 6", and 12" luminaires including Lumination™ LED Luminaires by GE Lighting Solutions. For more information visit: www.gelightingsolutions.com.

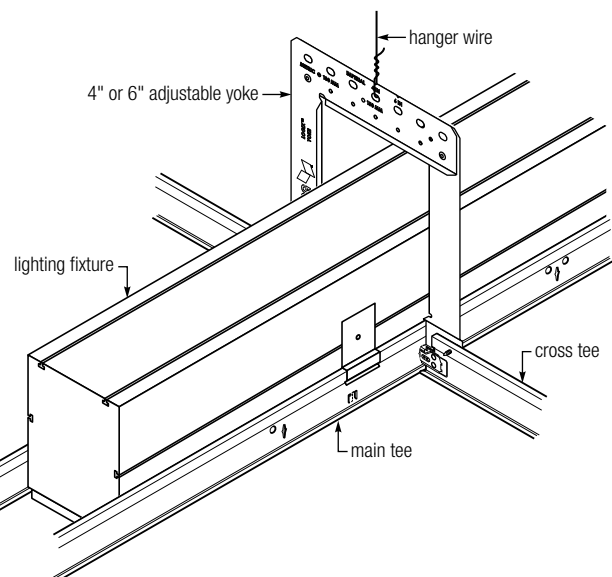

DESIGN CONSIDERATIONS

Layout Options

Utility Channel Created with Main Tees

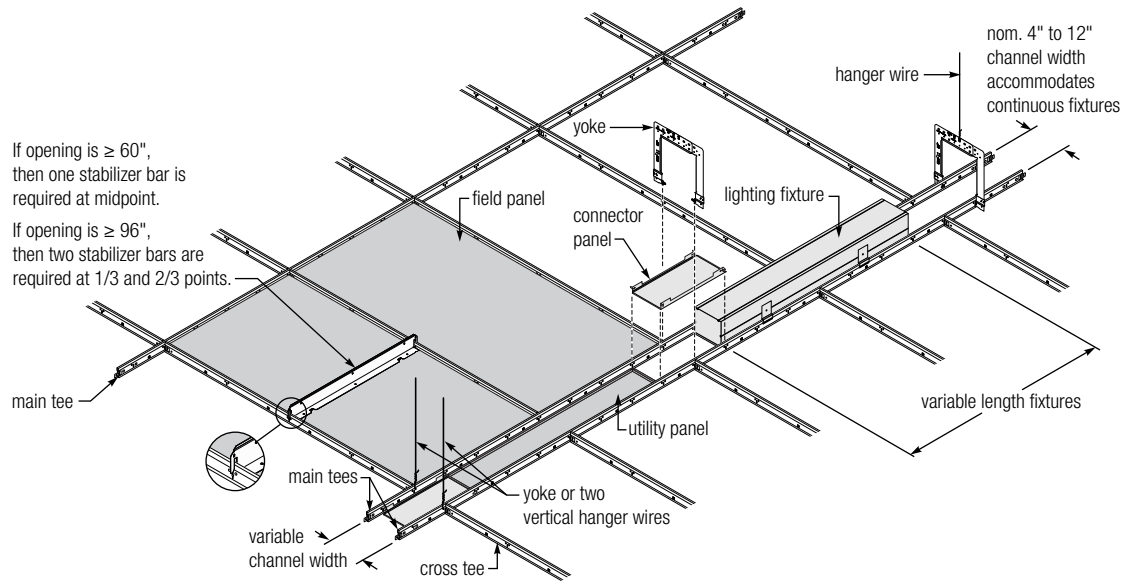

Utility Channel Created with Cross Tees

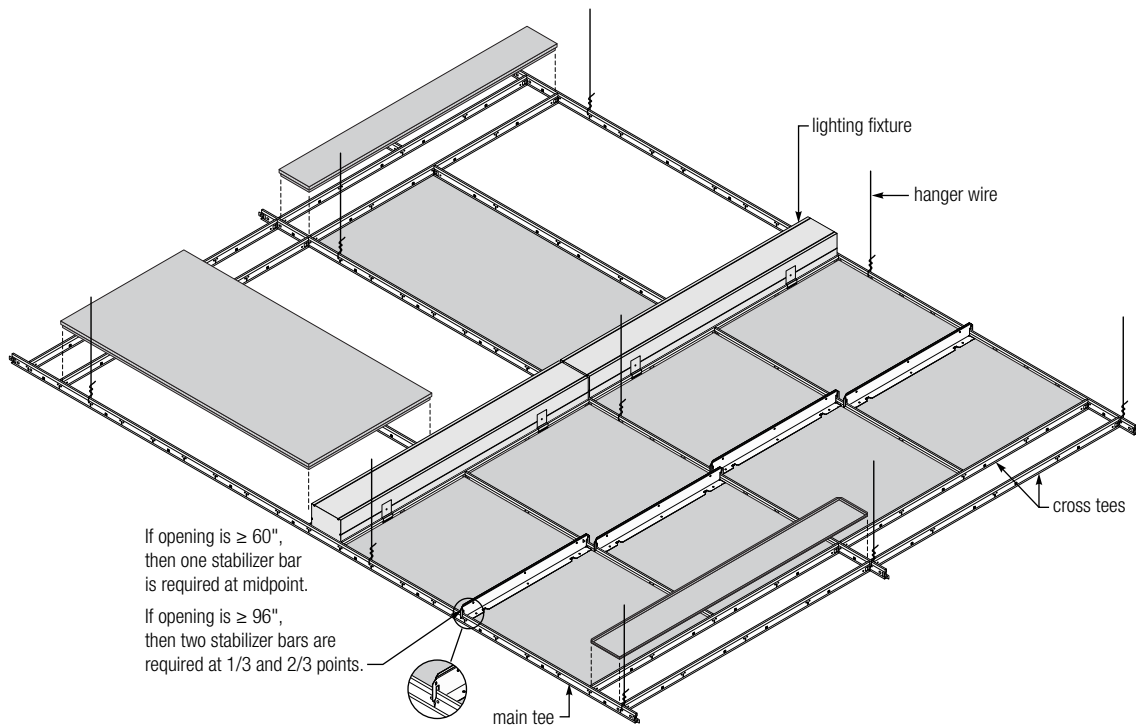

DESIGN CONSIDERATIONS

Ceiling Modules

Off-Module Units

Off-Module units represent assemblies where typical ceiling panel sizes are utilized between the utility channels. With the addition of the utility channel, this creates off-module or nonstandard channel-to-channel spacing.

On-Module Units

On-Module units represent assemblies where atypical ceiling panel sizes are utilized between the utility channels. With the addition of the utility channel, this creates on-module or standard channel-to-channel spacing.

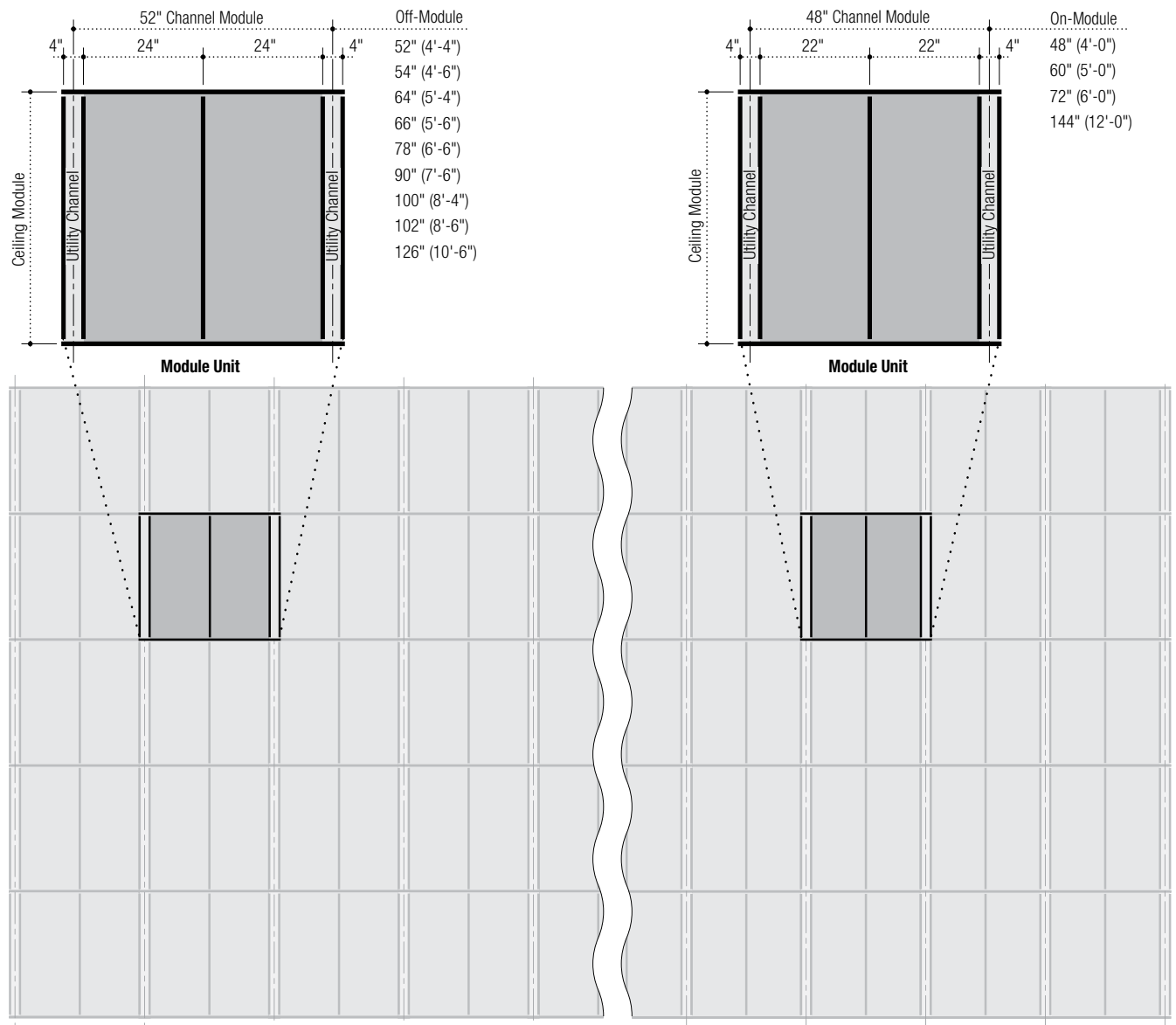

DESIGN CONSIDERATIONS

Utility Channel Options

Numerous mechanical configurations in the utility channel are possible. Coordination of light fixtures, mechanical grilles, channel panels, and infill panels can vary based on function, code requirements, and architectural design intent. Contact your sales representative for more information.

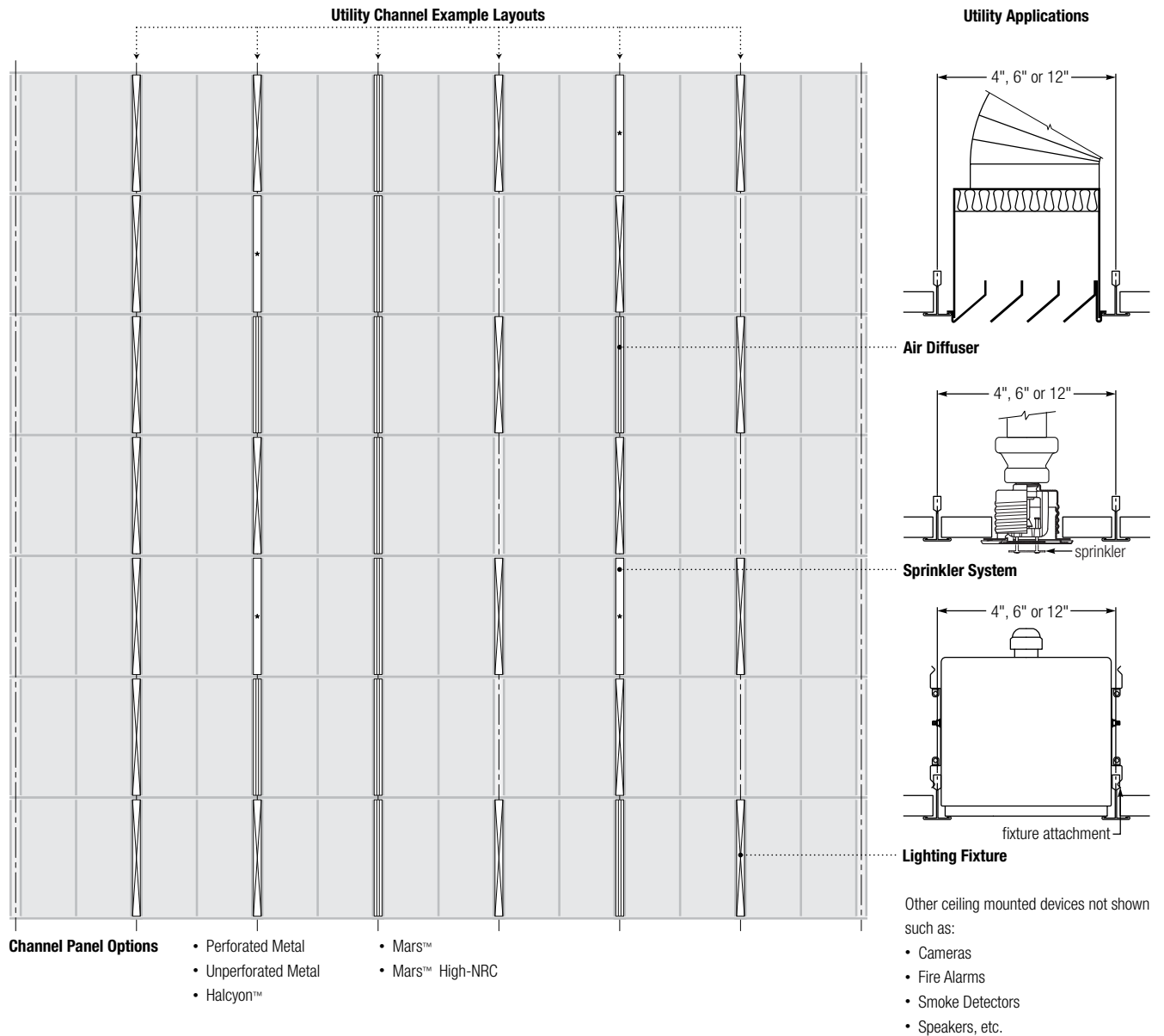

DESIGN CONSIDERATIONS

Continuous Utility Channels

Virtually all suspended ceiling systems are possible with a continuous utility channel system. Nearly all suspended ceiling systems can be installed between continuous utility channels. Contact your sales representative for more information.

Standard 2' x 2' Ceiling Layout

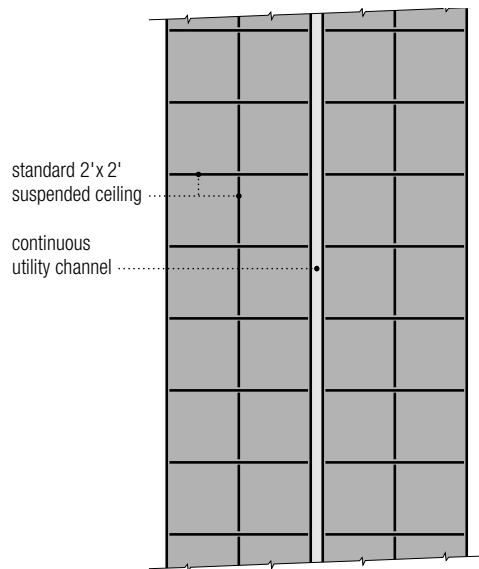

Standard 2' x 4' Ceiling Layout

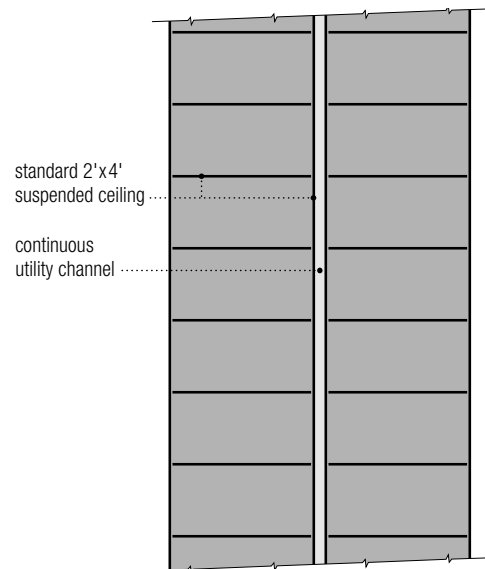

Standard 30" x 30" Ceiling Layout

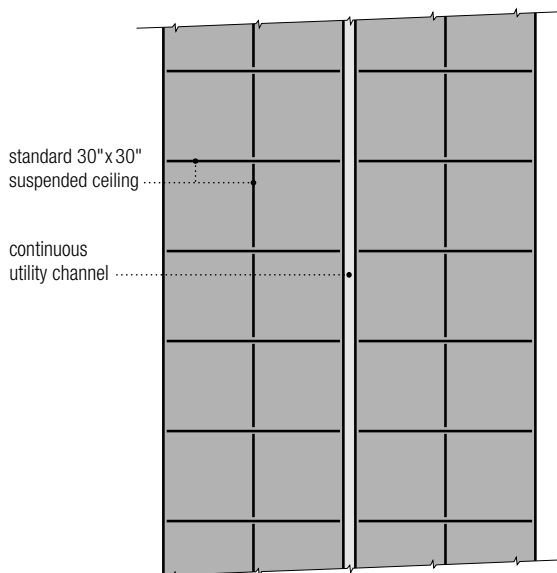

Standard 4' x 4' Ceiling Layout

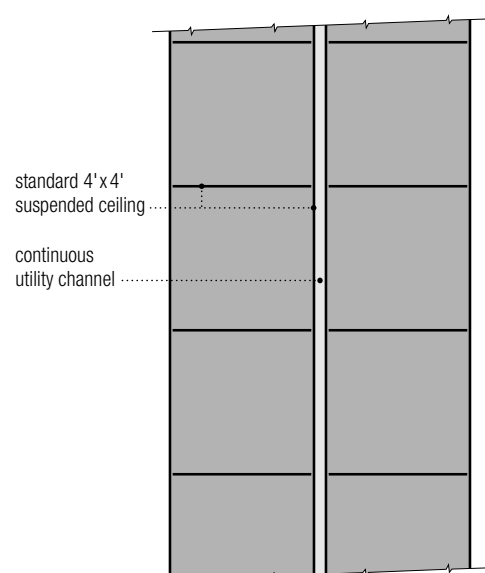

DESIGN CONSIDERATIONS

Drywall Ceilings

The USG drywall suspension system is a pre-engineered drywall ceiling system specifically created to simplify the design and construction of drywall ceilings. The system allows you to create unique and conventional drywall ceilings. The system assembles quickly and easily for faster installation and allows for the easy transition to acoustical ceilings, and vertical, horizontal, and curved surfaces. The USG drywall suspension system components come with a 10-year warranty and the system has a lifetime limited warranty when used with USG Sheetrock® Brand gypsum panels.

Integrating linear luminaires with the USG drywall suspension system creates a ceiling with advanced engineering, crisp lines and a strikingly pure aesthetic.

Example Layouts

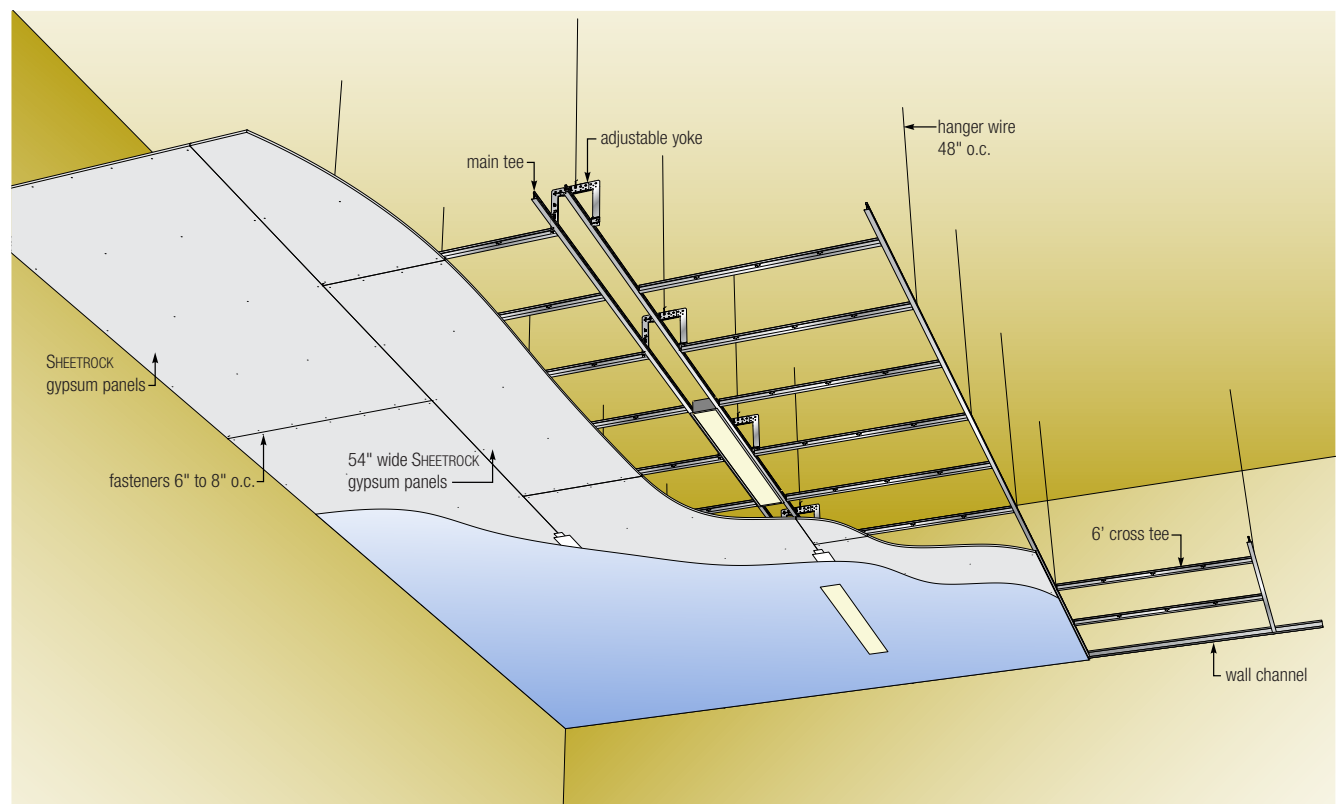

DESIGN CONSIDERATIONS

Drywall Ceilings

Example Layouts

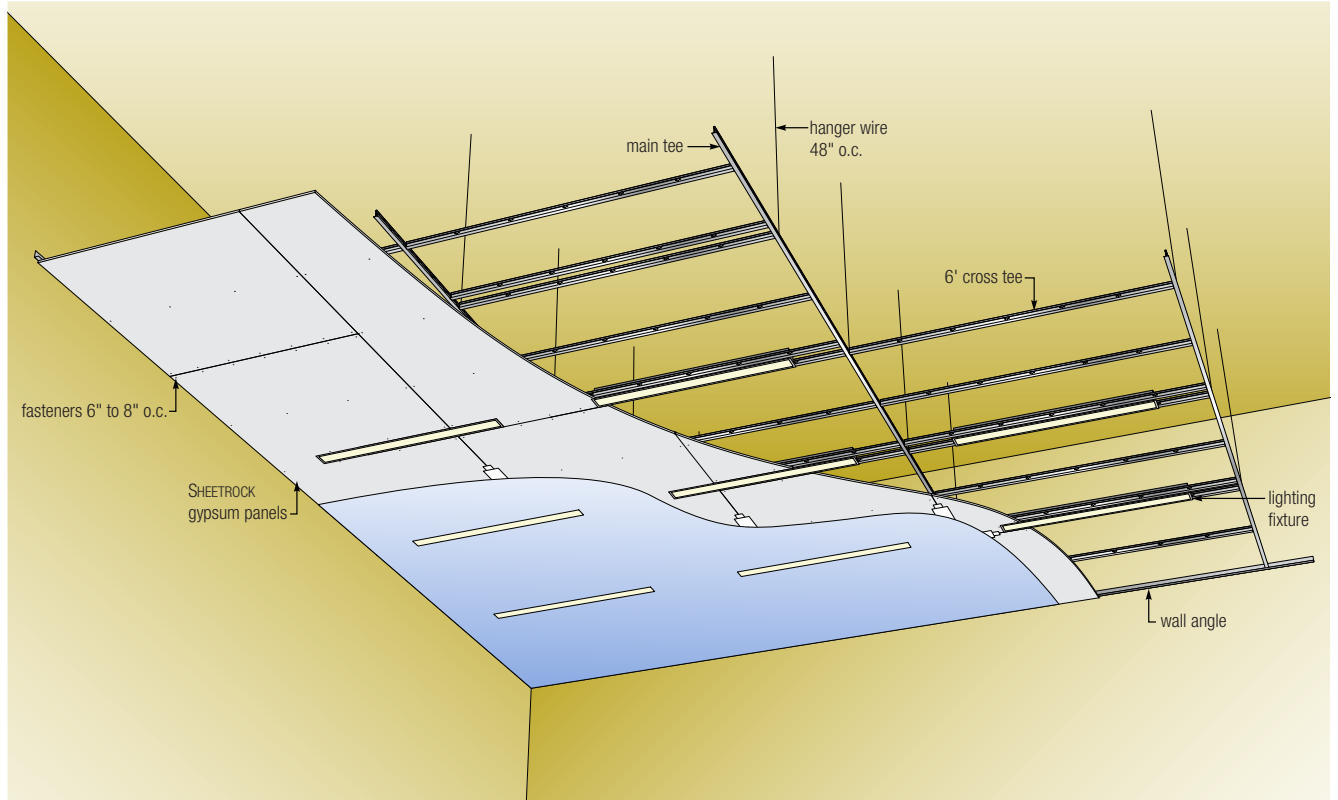

Example Luminaire Applications

Trim Flange Luminaire

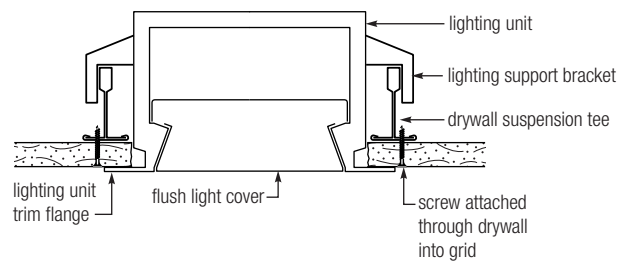

Trimless Luminaire

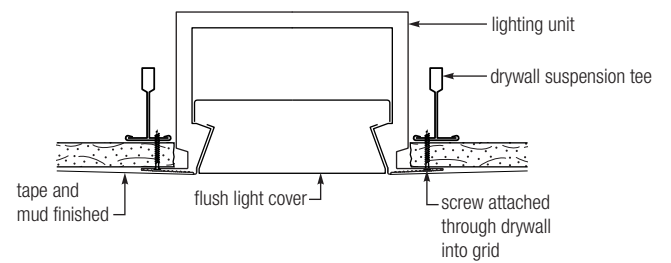

DESIGN CONSIDERATIONS

Chilled Beams

Chilled beams are part of a convection HVAC system where pipes of water are fed through a heat exchanger called a chilled beam for the purpose of controlling the climate of the space below. Chilled beams can be either active or passive. Active beams provide ventilation air in addition to cooling, while passive beams consist of a cooling coil in an enclosure. Multi-service chilled beams can integrate a variety of other services including speakers, lighting, sprinkler heads, etc. Chilled beams can either be exposed below the suspended ceiling or integrated into the suspended ceiling. Logix is designed to accommodate 12 in. chilled beam fixtures and integrate them into the 12 in. Logix utility channel. Larger chilled beams may be incorporated between utility channels.

Example Layouts

Continuous Utility Channels

12" Chilled Beam

Typical 12" x 6' Chilled Beam

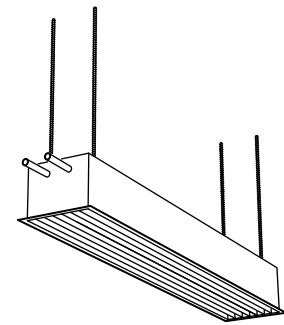
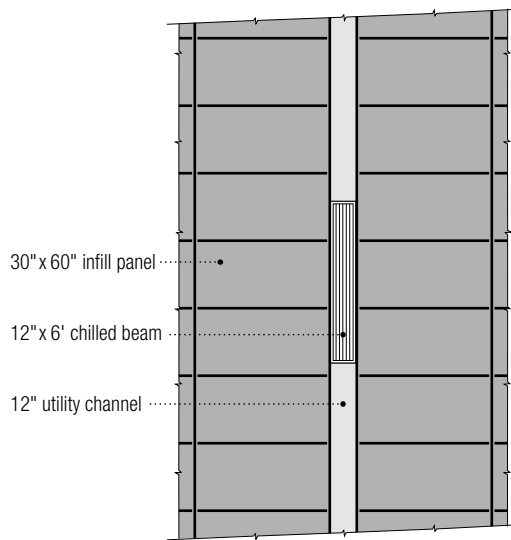

12" Chilled Beam

Typical 12" x 6' Chilled Beam

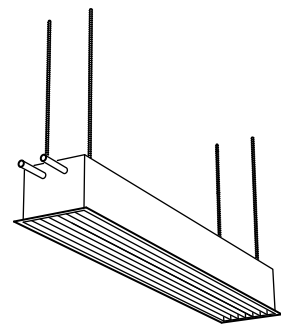
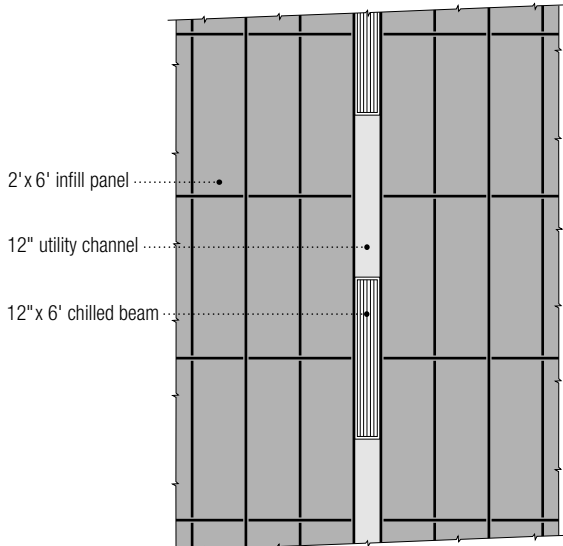

DESIGN CONSIDERATIONS

Chilled Beams

Example Layouts

Fixed Utility Channel

12" Chilled Beam

Typical 12" x 6' Chilled Beam

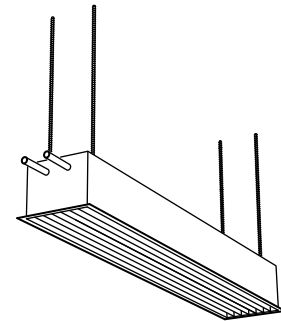
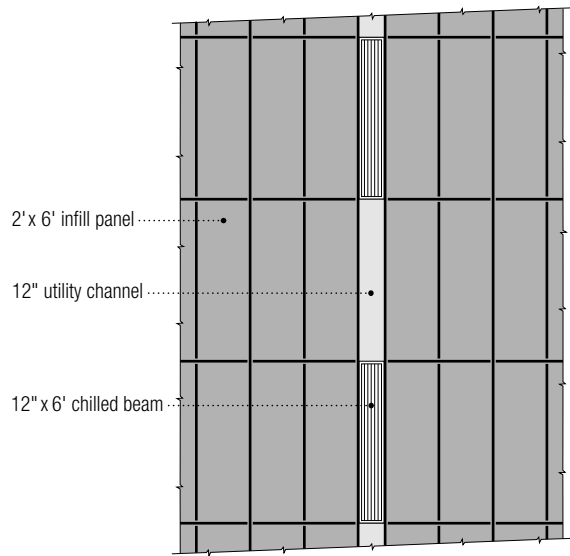

Large Chilled Beam

2' x 8' Chilled Beam Between Utility Channels

Typical 2' x 8' Chilled Beam

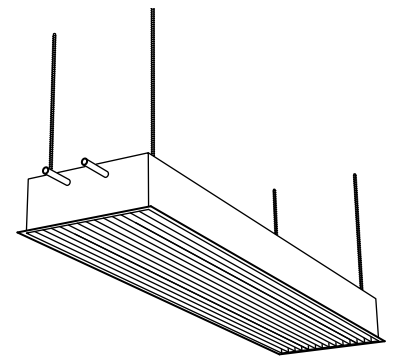
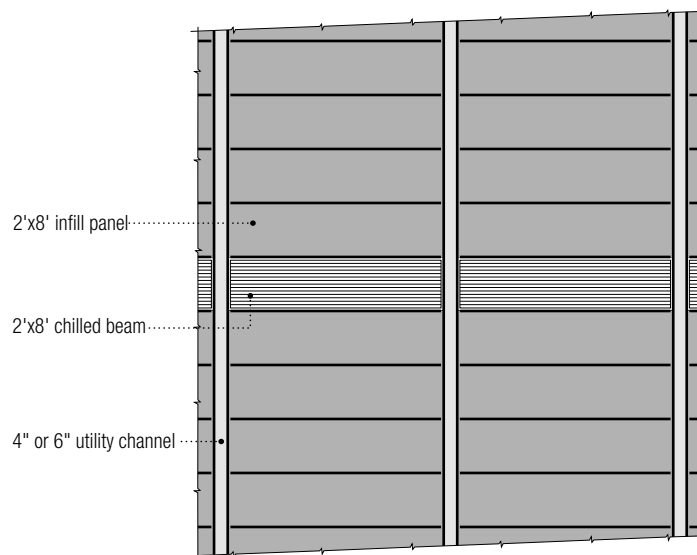

DESIGN CONSIDERATIONS

Logix Partners

Logix Partners

Logix is compatible with a wide selection of 4 in., 6 in., and 12 in. luminaires and utilities, as well as 100 mm, 150 mm, and 300 mm luminaires and utilities. Luminaires and utilities. USG has dedicated a permanent space to test and evaluate compatible products and prequalify them for fit and finish. For more information about the dimensions of Logix components and assemblies, please refer to IC609 Logix Critical System Dimensions.

Lighting

- Amerlux
- A Light
- Focal Point
- GE Lighting
- Zumtobel

Diffuser









- Carnes

Sprinkler

- SprinkFlex











On-Module Channel Spacing

4' and 5' Ceiling Modules

	Channel Width	Ceiling Module	On-Center Channel Spacing	Infill Panels	PANZ Metal Option		System	Page
					Infill Panel	Channel Panel		
4" Channel								
	4"	4'	4'	22" x 48"			764	34-35
	4"	4'	4'	22" x 24"			996	36-37
	4"	4'	4'	44" x 24"			952	38-39
	4"	4'	4'	44" x 48"			375	40-41
	4"	5'	5'	56" x 20"			537	42-43
	4"	5'	5'	28" x 30"			339	44-45
	4"	5'	5'	28" x 60"			433	46-47
	4"	5'	5'	56" x 30"			524	48-49
	4"	4'	12'	46" x 48" 48" x 48"			795	50-51







On-Module Channel Spacing

4' and 5' Ceiling Modules

	Channel Width	Ceiling Module	On-Center Channel Spacing	Infill Panels	PANZ Metal Option		System	Page
					Infill Panel	Channel Panel		
6" Channel								
	6"	4'	4'	42" x 48"		•	346	52-53
	6"	4'	4'	42" x 24"		•	727	54-55
	6"	4'	4'	21" x 24"		•	838	56-57
	6"	4'	4'	21" x 48"		•	646	58-59
	6"	4'	5'	54" x 48"		•	363	60-61
	6"	5'	5'	54" x 20"		•	753	62-63
	6"	5'	5'	27" x 30"		•	856	64-65
	6"	5'	5'	27" x 60"		•	343	66-67
	6"	5'	5'	54" x 30"		•	865	68-69
	6"	5'	12'	45" x 48" 48" x 48"		•	275	70-71



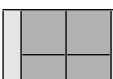
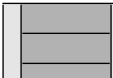

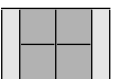
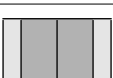





On-Module Channel Spacing

4' and 5' Ceiling Modules

	Channel Width	Ceiling Module	On-Center Channel Spacing	Infill Panels	PANZ Metal Option		System	Page
					Infill Panel	Channel Panel		
12" Channel								
	12"	4'	5'	24" x 48"	●	●	944	72-73
	12"	4'	5'	24" x 24"	●	●	464	74-75
	12"	4'	5'	48" x 48"		●	279	76-77
	12"	5'	6'	30" x 60"	●	●	372	78-79
	12"	5'	6'	30" x 30"	●	●	934	80-81
	12"	5'	6'	60" x 20"	●	●	649	82-83
	12"	6'	5'	24" x 48"	●	●	997	84-85
	12"	6'	5'	24" x 24"	●	●	665	86-87
	12"	6'	5'	24" x 72"	●	●	785	88-89

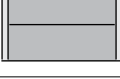
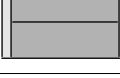









Off-Module Channel Spacing

4', 5' and 6' Ceiling Modules
 4", 6" and 12" Configurations

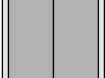
	Channel Width	Ceiling Module	On-Center Channel Spacing	Infill Panels	PANZ Metal Option		System	Page
					Infill Panel	Channel Panel		
	4"	4'	4' - 4"	24" x 48"	●		367	90-91
	6"	4'	4' - 6"	24" x 48"	●	●	598	92-93
	4"	4'	4' - 4"	24" x 24"	●		977	94-95
	6"	4'	4' - 6"	24" x 24"	●	●	862	96-97
	4"	4'	4' - 4"	48" x 48"			527	98-99
	6"	4'	4' - 6"	48" x 48"		●	244	100-101
	4"	4'	6' - 6"	72" x 24"	●		529	102-103
	6"	4'	6' - 6"	72" x 24"	●	●	755	104-105
	6"	4'	6' - 6"	24" x 24"	●	●	574	106-107
	6"	4'	7' - 6"	42" x 48"		●	497	108-109
	4"	4'	8' - 4"	96" x 24"			722	110-111
	6"	4'	8' - 6"	48" x 48"		●	754	112-113

Off-Module Channel Spacing

4', 5' and 6' Ceiling Modules
 4", 6" and 12" Configurations

	Channel Width	Ceiling Module	On-Center Channel Spacing	Infill Panels	PANZ Metal Option		System	Page
					Infill Panel	Channel Panel		
	6"	4'	8' - 6"	96" x 24"		●	664	114-115
	6"	4'	8' - 6"	96" x 48"		●	979	116-117
	6"	4'	8' - 6"	24" x 24"	●	●	776	118-119
	6"	4'	10' - 6"	120" x 24"		●	383	120-121
	4"	5'	5' - 4"	30" x 60"	●		697	122-123
	6"	5'	5' - 6"	30" x 60"	●	●	369	124-125
	4"	5'	5' - 4"	30" x 30"		●	378	126-127
	6"	5'	5' - 6"	30" x 30"	●	●	642	128-129
	4"	6'	4' - 4"	24" x 48"	●	●	859	130-131
	6"	6'	4' - 6"	24" x 48"	●	●	824	132-133

Off-Module Channel Spacing

4', 5' and 6' Ceiling Modules
 4", 6" and 12" Configurations

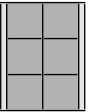
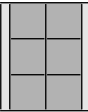
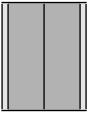
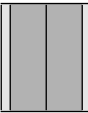
	Channel Width	Ceiling Module	On-Center Channel Spacing	Infill Panels	PANZ Metal Option		System	Page
					Infill Panel	Channel Panel		
	4"	6'	4' - 4"	24" x 24"	●	●	724	134-135
	6"	6'	4' - 6"	24" x 24"	●	●	292	136-137
	4"	6'	4' - 4"	24" x 72"	●	●	562	138-139
	6"	6'	4' - 6"	24" x 72"	●	●	643	140-141

On-Module Channel Spacing









4' Ceiling Module

4" Channel

System 764

22" x 48" Infill Panel

Selector

Channel Width	Ceiling Module	On-Center Channel Spacing	Infill Panels	Panel Edge	Suspension System	
4"	4' (48")	4' (48")	HALCYON	22" x 48" x 1"	FL 	DXT, DXI
					SL 	DX
					SQ 	DX
			MARS	22" x 48 x 3/4"	FLB 	DXT, DXI
					SLT 	DX
					SQ 	DX
			MARS High-NRC	22" x 48" x 7/8"	FLB 	DXT, DXI
					SLT 	DX
					SQ 	DX

Module Layout

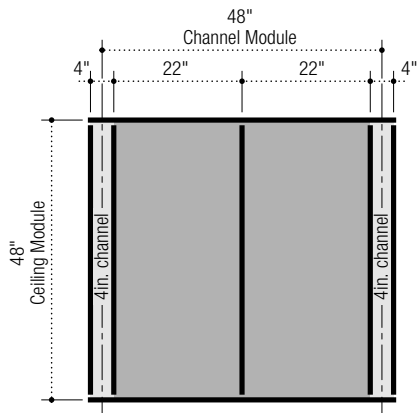

Panel Layout

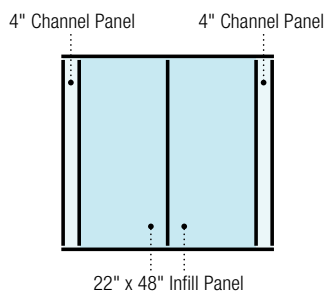

Suspension System Layout

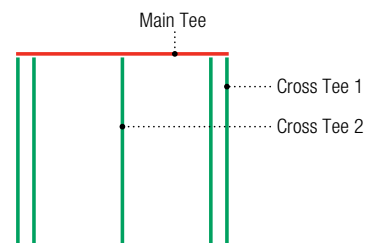

Order Information
System 764

4' Ceiling Module

4" Channel
22" x 48" Infill Panel



Step 1. Select Panels

Step 2. Select Edge for Panels

			FL/FLB		SL/SLT		SQ	
			Edge	Item No.	Edge	Item No.	Edge	Item No.
Infill Panels	HALCYON	22" x 48" x 1"	FL	<input type="checkbox"/> 97468	SL	<input type="checkbox"/> 97441	SQ	<input type="checkbox"/> 97414
	MARS	22" x 48" x 3/4"	FLB	<input type="checkbox"/> 86575	SLT	<input type="checkbox"/> 86553	SQ	<input type="checkbox"/> 86525
	MARS High-NRC	22" x 48" x 7/8"	FLB	<input type="checkbox"/> 86486	SLT	<input type="checkbox"/> 86454	SQ	<input type="checkbox"/> 86417

Channel Panels	HALCYON	4" x 48" x 1"	FL	<input type="checkbox"/> 97460	SL	<input type="checkbox"/> 97430	SQ	<input type="checkbox"/> 97402
	MARS	4" x 48" x 3/4"	FLB	<input type="checkbox"/> 86568	SLT	<input type="checkbox"/> 86540	SQ	<input type="checkbox"/> 86514
	MARS High-NRC	4" x 48" x 7/8"	FLB	<input type="checkbox"/> 86475	SLT	<input type="checkbox"/> 86440	SQ	<input type="checkbox"/> 86402

Step 3. Select Corresponding Grid for Selected Panels

			Qty	Item No.	Qty	Item No.	Qty	Item No.
Suspension Systems	CENTRICITEE DXT	Main Tee		<input type="checkbox"/> DXT24SP101				
		Cross Tee 1	2	<input type="checkbox"/> DXT424				
		Cross Tee 2	1	<input type="checkbox"/> DXT424				
	IDENTITEE DXI	Main Tee		<input type="checkbox"/> DXI24SP101				
		Cross Tee 1	2	<input type="checkbox"/> DXI424				
		Cross Tee 2	1	<input type="checkbox"/> DXI424				
	DONN DX	Main Tee			<input type="checkbox"/> DX24SP101		<input type="checkbox"/> DX24SP101	
		Cross Tee 1			2	<input type="checkbox"/> DX422	2	<input type="checkbox"/> DX422
		Cross Tee 2			1	<input type="checkbox"/> DX422	1	<input type="checkbox"/> DX422

Suspension System Estimator

	Length	Sq. Ft.	Main Tee Usage Per Sq. Ft.	Cross Tee 1 Usage Per Sq. Ft.	Cross Tee 2 Usage Per Sq. Ft.	
System Module	48"	16	0.25	0.50	0.25	

Note: Multiply the ceiling area (SF) by the Usage Factor (UF). This calculation will determine lineal footage of suspension system components required. Please refer to the front of this catalogue or IC592 for stabilizer bar usage.









On-Module Channel Spacing

System 996

4' Ceiling Module

4" Channel
22" x 24" Infill Panel

Selector

Channel Width	Ceiling Module	On-Center Channel Spacing	Infill Panels	Panel Edge	Suspension System
4"	4' (48")	4' (48")	HALCYON 22" x 24" x 1"	FL 	DXT, DXI
				SL 	DX
				SQ 	DX, DXT
			MARS 22" x 24" x 3/4"	FLB 	DXT, DXI
				SLT 	DX
				SQ 	DX, DXT
			MARS High-NRC 22" x 24" x 7/8"	FLB 	DXT, DXI
				SLT 	DX
				SQ 	DX, DXT

Module Layout

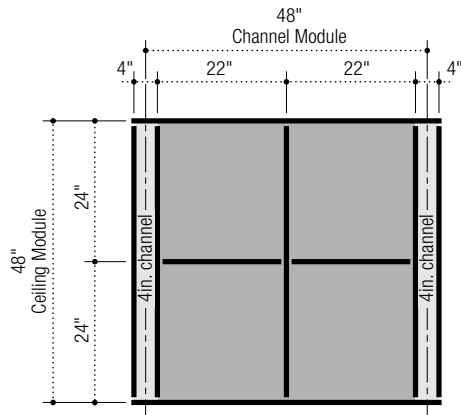

Panel Layout

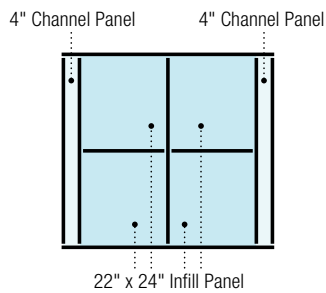

Suspension System Layout

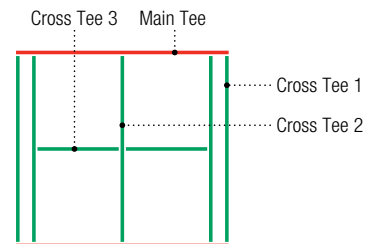

Order Information
System 996

4' Ceiling Module

4" Channel
22" x 24" Infill Panel



Step 1. Select Panels

Step 2. Select Edge for Panels

			FL/FLB		SL/SLT		SQ	
			Edge	Item No.	Edge	Item No.	Edge	Item No.
Infill Panels	HALCYON	22" x 24" x 1"	FL	<input type="checkbox"/> 97467	SL	<input type="checkbox"/> 97440	SQ	<input type="checkbox"/> 97413
	MARS	22" x 24" x 3/4"	FLB	<input type="checkbox"/> 86574	SLT	<input type="checkbox"/> 86552	SQ	<input type="checkbox"/> 86524
	MARS High-NRC	22" x 24" x 7/8"	FLB	<input type="checkbox"/> 86485	SLT	<input type="checkbox"/> 86453	SQ	<input type="checkbox"/> 86416

Channel Panels	HALCYON	4" x 48" x 1"	FL	<input type="checkbox"/> 97460	SL	<input type="checkbox"/> 97430	SQ	<input type="checkbox"/> 97402
	MARS	4" x 48" x 3/4"	FLB	<input type="checkbox"/> 86568	SLT	<input type="checkbox"/> 86540	SQ	<input type="checkbox"/> 86514
	MARS High-NRC	4" x 48" x 7/8"	FLB	<input type="checkbox"/> 86475	SLT	<input type="checkbox"/> 86440	SQ	<input type="checkbox"/> 86402

Step 3. Select Corresponding Grid for Selected Panels

			Qty	Item No.	Qty	Item No.	Qty	Item No.
Suspension Systems	CENTRICITEE DXT	Main Tee		<input type="checkbox"/> DXT24SP101				<input type="checkbox"/> DXT24SP101
		Cross Tee 1	2	<input type="checkbox"/> DXT424			2	<input type="checkbox"/> DXT424
		Cross Tee 2	1	<input type="checkbox"/> DXT424			1	<input type="checkbox"/> DXT424
		Cross Tee 3	2	<input type="checkbox"/> DXT2222			2	<input type="checkbox"/> DXT2222
	IDENTITEE DXI	Main Tee		<input type="checkbox"/> DXI24SP101				
		Cross Tee 1	2	<input type="checkbox"/> DXI424				
		Cross Tee 2	1	<input type="checkbox"/> DXI424				
		Cross Tee 3	2	<input type="checkbox"/> DXT2222				
	DONN DX	Main Tee				<input type="checkbox"/> DX24SP101		<input type="checkbox"/> DX24SP101
		Cross Tee 1			2	<input type="checkbox"/> DX422	2	<input type="checkbox"/> DX422
		Cross Tee 2			1	<input type="checkbox"/> DX422	1	<input type="checkbox"/> DX422
		Cross Tee 3			2	<input type="checkbox"/> DX2216	2	<input type="checkbox"/> DX2216

Suspension System Estimator

	Length	Sq. Ft.	Main Tee Usage Per Sq. Ft.	Cross Tee 1 Usage Per Sq. Ft.	Cross Tee 2 Usage Per Sq. Ft.	Cross Tee 3 Usage Per Sq. Ft.
System Module	48"	16	0.25	0.50	0.25	0.23

Note: Multiply the ceiling area (SF) by the Usage Factor (UF). This calculation will determine lineal footage of suspension system components required. Please refer to the front of this catalogue or IC592 for stabilizer bar usage.

On-Module Channel Spacing









System 952

4' Ceiling Module

4" Channel

44" x 24" Infill Panel

Selector

Channel Width	Ceiling Module	On-Center Channel Spacing	Infill Panels	Panel Edge	Suspension System
4"	4' (48")	4' (48")	HALCYON 44" x 24" x 1"	FL 	DXT, DXI
				SL 	DX
				SQ 	DX
			MARS 44" x 24" x 3/4"	FLB 	DXT, DXI
				SLT 	DX
				SQ 	DX
			MARS High-NRC 44" x 24" x 7/8"	FLB 	DXT, DXI
				SLT 	DX
				SQ 	DX

Module Layout

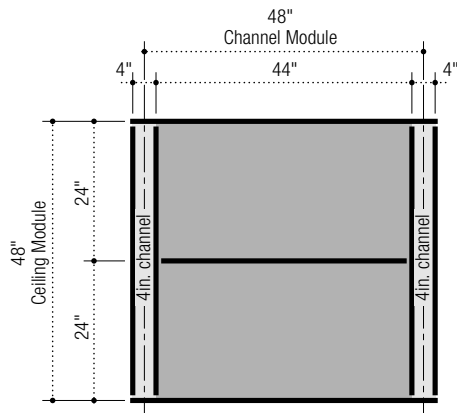

Panel Layout

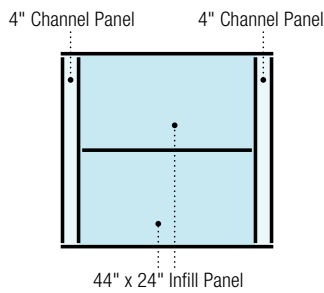

Suspension System Layout

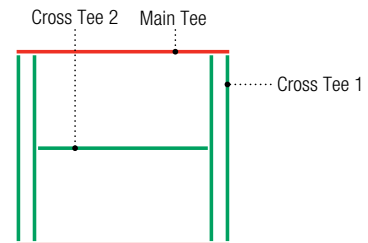

Order Information
System 952

4' Ceiling Module

4" Channel
44" x 24" Infill Panel



Step 1. Select Panels

Step 2. Select Edge for Panels

			FL/FLB		SL/SLT		SQ	
			Edge	Item No.	Edge	Item No.	Edge	Item No.
Infill Panels	HALCYON	44" x 24" x 1"	FL	<input type="checkbox"/> 97470	SL	<input type="checkbox"/> 97444	SQ	<input type="checkbox"/> 97416
	MARS	44" x 24" x 3/4"	FLB	<input type="checkbox"/> 86578	SLT	<input type="checkbox"/> 86556	SQ	<input type="checkbox"/> 86528
	MARS High-NRC	44" x 24" x 7/8"	FLB	<input type="checkbox"/> 86489	SLT	<input type="checkbox"/> 86457	SQ	<input type="checkbox"/> 86420

Channel Panels	HALCYON	4" x 48" x 1"	FL	<input type="checkbox"/> 97460	SL	<input type="checkbox"/> 97430	SQ	<input type="checkbox"/> 97402
	MARS	4" x 48" x 3/4"	FLB	<input type="checkbox"/> 86568	SLT	<input type="checkbox"/> 86540	SQ	<input type="checkbox"/> 86514
	MARS High-NRC	4" x 48" x 7/8"	FLB	<input type="checkbox"/> 86475	SLT	<input type="checkbox"/> 86440	SQ	<input type="checkbox"/> 86402

Step 3. Select Corresponding Grid for Selected Panels

			Qty	Item No.	Qty	Item No.	Qty	Item No.
Suspension Systems	CENTRICITEE DXT	Main Tee		<input type="checkbox"/> DXT24SP101				
		Cross Tee 1	2	<input type="checkbox"/> DXT424				
		Cross Tee 2	1	<input type="checkbox"/> DXT4422				
	IDENTITEE DXI	Main Tee		<input type="checkbox"/> DXI24SP101				
		Cross Tee 1	2	<input type="checkbox"/> DXI424				
		Cross Tee 2	1	<input type="checkbox"/> DXI4424				
	DONN DX	Main Tee			<input type="checkbox"/> DX24SP101		<input type="checkbox"/> DX24SP101	
		Cross Tee 1			2	<input type="checkbox"/> DX422	2	<input type="checkbox"/> DX422
		Cross Tee 2			1	<input type="checkbox"/> DX44	1	<input type="checkbox"/> DX44

Suspension System Estimator

	Length	Sq. Ft.	Main Tee Usage Per Sq. Ft.	Cross Tee 1 Usage Per Sq. Ft.	Cross Tee 2 Usage Per Sq. Ft.	
System Module	48"	16	0.25	0.50	0.23	

Note: Multiply the ceiling area (SF) by the Usage Factor (UF). This calculation will determine lineal footage of suspension system components required. Please refer to the front of this catalogue or IC592 for stabilizer bar usage.

On-Module Channel Spacing



4' Ceiling Module

4" Channel

System 375

44" x 48" Infill Panel

Selector

Channel Width	Ceiling Module	On-Center Channel Spacing	Infill Panels	Panel Edge	Suspension System
4"	4' (48")	4' (48")	HALCYON 44" x 48" x 1"	FL 	DXT, DXI
				SL 	DX
				SQ 	DX

Module Layout

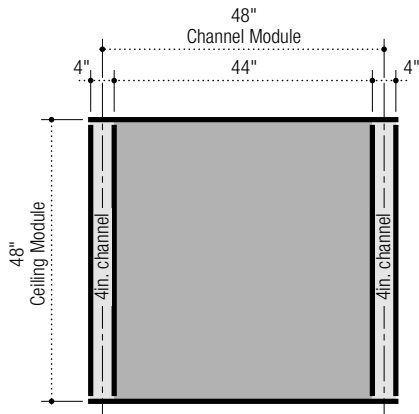

Panel Layout

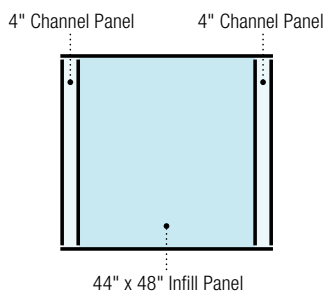

Suspension System Layout

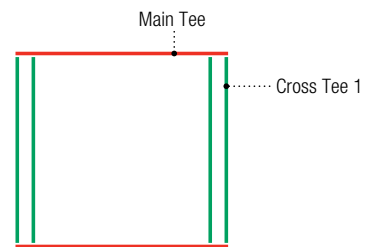

Order Information
System 375

4' Ceiling Module

4" Channel
44" x 48" Infill Panel



Step 1. Select Panels

Step 2. Select Edge for Panels

			FL/FLB		SL/SLT		SQ	
			Edge	Item No.	Edge	Item No.	Edge	Item No.
Infill Panels	HALCYON	44" x 48" x 1"	FL	<input type="checkbox"/> 97475	SL	<input type="checkbox"/> 97455	SQ	<input type="checkbox"/> 97425

Channel Panels	HALCYON	4" x 48" x 1"	FL	<input type="checkbox"/> 97460	SL	<input type="checkbox"/> 97430	SQ	<input type="checkbox"/> 97402
-----------------------	---------	---------------	----	--------------------------------	----	--------------------------------	----	--------------------------------

Step 3. Select Corresponding Grid for Selected Panels

			Qty	Item No.	Qty	Item No.	Qty	Item No.
Suspension Systems	CENTRICITEE DXT	Main Tee		<input type="checkbox"/> DXT24SP101				
		Cross Tee 1	2	<input type="checkbox"/> DXT424				
	IDENTITEE DXI	Main Tee		<input type="checkbox"/> DXI24SP101				
		Cross Tee 1	2	<input type="checkbox"/> DXI424				
	DONN DX	Main Tee			<input type="checkbox"/> DX24SP101		<input type="checkbox"/> DX24SP101	
		Cross Tee 1			2	<input type="checkbox"/> DX422	2	<input type="checkbox"/> DX422

Suspension System Estimator

	Length	Sq. Ft.	Main Tee Usage Per Sq. Ft.	Cross Tee 1 Usage Per Sq. Ft.	
System Module	48"	16	0.25	0.50	

Note: Multiply the ceiling area (SF) by the Usage Factor (UF). This calculation will determine lineal footage of suspension system components required. Please refer to the front of this catalogue or IC592 for stabilizer bar usage.

On-Module Channel Spacing









5' Ceiling Module

4" Channel

System 537

56" x 20" Infill Panel

Selector

Channel Width	Ceiling Module	On-Center Channel Spacing	Infill Panels	Panel Edge	Suspension System
4"	5' (60")	5' (60")	HALCYON 56" x 20" x 1"	FL 	DXT, DXI
				SL 	DX
				SQ 	DX
			MARS 56" x 20" x 3/4"	FLB 	DXT, DXI
				SLT 	DX
				SQ 	DX
			MARS High-NRC 56" x 20" x 7/8"	FLB 	DXT, DXI
				SLT 	DX
				SQ 	DX

Module Layout

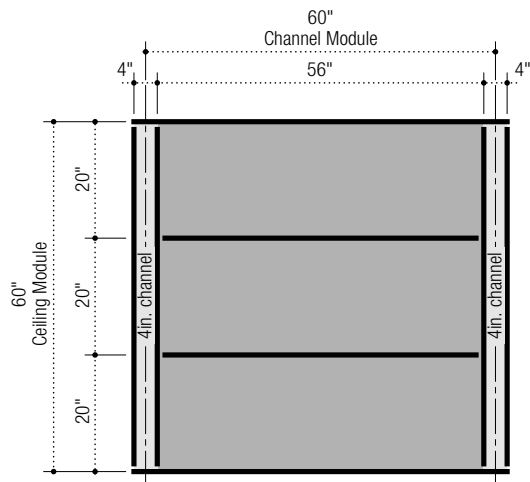

Panel Layout

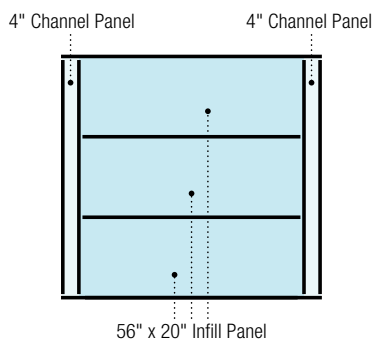

Suspension System Layout

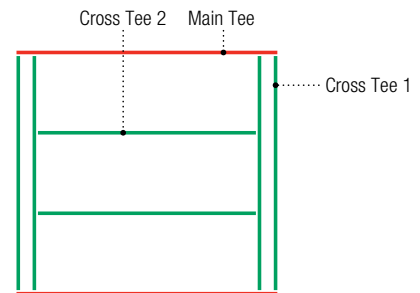

Order Information
System 537

5' Ceiling Module

4" Channel
56" x 20" Infill Panel

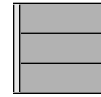

Step 1. Select Panels

Step 2. Select Edge for Panels

			FL/FLB		SL/SLT		SQ	
			Edge	Item No.	Edge	Item No.	Edge	Item No.
Infill Panels	HALCYON	56" x 20" x 1"	FL	<input type="checkbox"/> 97464	SL	<input type="checkbox"/> 97437	SQ	<input type="checkbox"/> 97408
	MARS	56" x 20" x 3/4"	FLB	<input type="checkbox"/> 86571	SLT	<input type="checkbox"/> 86548	SQ	<input type="checkbox"/> 86520
	MARS High-NRC	56" x 20" x 7/8"	FLB	<input type="checkbox"/> 86480	SLT	<input type="checkbox"/> 86448	SQ	<input type="checkbox"/> 86411

Channel Panels	HALCYON	4" x 60" x 1"	FL	<input type="checkbox"/> 97461	SL	<input type="checkbox"/> 97431	SQ	<input type="checkbox"/> 97403
	MARS	4" x 60" x 3/4"	FLB	<input type="checkbox"/> 86569	SLT	<input type="checkbox"/> 86541	SQ	<input type="checkbox"/> 86515
	MARS High-NRC	4" x 60" x 7/8"	FLB	<input type="checkbox"/> 86476	SLT	<input type="checkbox"/> 86441	SQ	<input type="checkbox"/> 86403

Step 3. Select Corresponding Grid for Selected Panels

			Qty	Item No.	Qty	Item No.	Qty	Item No.
Suspension Systems	CENTRICITEE DXT	Main Tee		<input type="checkbox"/> DXT24SP102				
		Cross Tee 1	2	<input type="checkbox"/> DXT524				
		Cross Tee 2	2	<input type="checkbox"/> DXT5622				
	IDENTITEE DXI	Main Tee		<input type="checkbox"/> DXI24SP102				
		Cross Tee 1	2	<input type="checkbox"/> DXI524				
		Cross Tee 2	2	<input type="checkbox"/> DXI5624				
	DONN DX	Main Tee			<input type="checkbox"/> DX24SP102		<input type="checkbox"/> DX24SP102	
		Cross Tee 1			2	<input type="checkbox"/> DX524	2	<input type="checkbox"/> DX524
		Cross Tee 2			2	<input type="checkbox"/> DX5616	2	<input type="checkbox"/> DX5616

Suspension System Estimator

	Length	Sq. Ft.	Main Tee Usage Per Sq. Ft.	Cross Tee 1 Usage Per Sq. Ft.	Cross Tee 2 Usage Per Sq. Ft.	
System Module	60"	25	0.20	0.40	0.37	

Note: Multiply the ceiling area (SF) by the Usage Factor (UF). This calculation will determine lineal footage of suspension system components required. Please refer to the front of this catalogue or IC592 for stabilizer bar usage.

On-Module Channel Spacing









5' Ceiling Module

4" Channel

System 339

28" x 30" Infill Panel

Selector

Channel Width	Ceiling Module	On-Center Channel Spacing	Infill Panels	Panel Edge	Suspension System
4"	5' (60")	5' (60")	HALCYON 28" x 30" x 1"	FL 	DXT, DXI
				SL 	DX
				SQ 	DX
			MARS 28" x 30" x 3/4"	FLB 	DXT, DXI
				SLT 	DX
				SQ 	DX
			MARS High-NRC 28" x 30" x 7/8"	FLB 	DXT, DXI
				SLT 	DX
				SQ 	DX

Module Layout

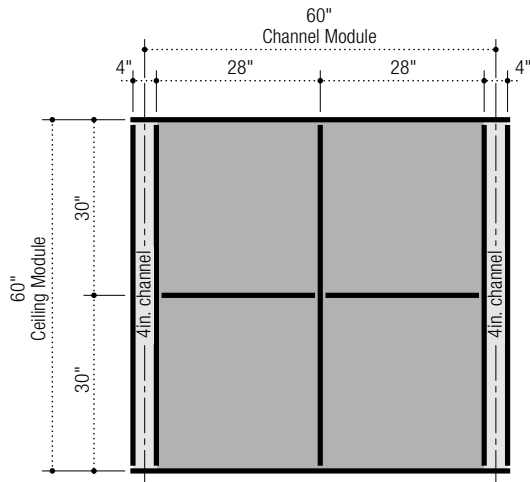

Panel Layout

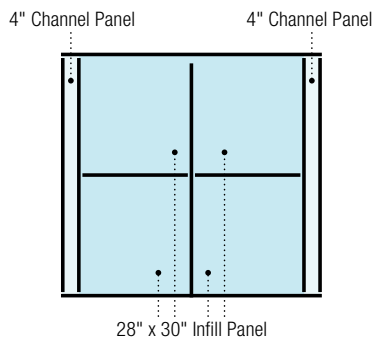

Suspension System Layout

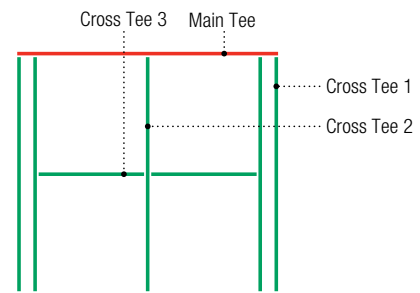

Order Information
System 339

5' Ceiling Module

4" Channel
28" x 30" Infill Panel

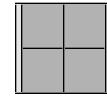

Step 1. Select Panels

Step 2. Select Edge for Panels

			FL/FLB		SL/SLT		SQ	
			Edge	Item No.	Edge	Item No.	Edge	Item No.
Infill Panels	HALCYON	28" x 30" x 1"	FL	<input type="checkbox"/> 97335	SL	<input type="checkbox"/> 97449	SQ	<input type="checkbox"/> 97419
	MARS	28" x 30" x 3/4"	FLB	<input type="checkbox"/> 86834	SLT	<input type="checkbox"/> 86559	SQ	<input type="checkbox"/> 86532
	MARS High-NRC	28" x 30" x 7/8"	FLB	<input type="checkbox"/> 86492	SLT	<input type="checkbox"/> 86459	SQ	<input type="checkbox"/> 86423

Channel Panels	HALCYON	4" x 60" x 1"	FL	<input type="checkbox"/> 97461	SL	<input type="checkbox"/> 97431	SQ	<input type="checkbox"/> 97403
	MARS	4" x 60" x 3/4"	FLB	<input type="checkbox"/> 86569	SLT	<input type="checkbox"/> 86541	SQ	<input type="checkbox"/> 86515
	MARS High-NRC	4" x 60" x 7/8"	FLB	<input type="checkbox"/> 86476	SLT	<input type="checkbox"/> 86441	SQ	<input type="checkbox"/> 86403

Step 3. Select Corresponding Grid for Selected Panels

			Qty	Item No.	Qty	Item No.	Qty	Item No.
Suspension Systems	CENTRICITEE DXT	Main Tee		<input type="checkbox"/> DXT24SP102				
		Cross Tee 1	2	<input type="checkbox"/> DXT524				
		Cross Tee 2	1	<input type="checkbox"/> DXT524				
		Cross Tee 3	2	<input type="checkbox"/> DXT2822				
	IDENTITEE DXI	Main Tee		<input type="checkbox"/> DXI24SP102				
		Cross Tee 1	2	<input type="checkbox"/> DXI524				
		Cross Tee 2	1	<input type="checkbox"/> DXI524				
		Cross Tee 3	2	<input type="checkbox"/> DXT2822				
	DONN DX	Main Tee			<input type="checkbox"/> DX24SP102		<input type="checkbox"/> DX24SP102	
		Cross Tee 1			2	<input type="checkbox"/> DX524	2	<input type="checkbox"/> DX524
		Cross Tee 2			1	<input type="checkbox"/> DX524	1	<input type="checkbox"/> DX524
		Cross Tee 3			2	<input type="checkbox"/> DX2816	2	<input type="checkbox"/> DX2816

Suspension System Estimator

	Length	Sq. Ft.	Main Tee Usage Per Sq. Ft.	Cross Tee 1 Usage Per Sq. Ft.	Cross Tee 2 Usage Per Sq. Ft.	Cross Tee 3 Usage Per Sq. Ft.
System Module	60"	25	0.20	0.40	0.20	0.19

Note: Multiply the ceiling area (SF) by the Usage Factor (UF). This calculation will determine lineal footage of suspension system components required. Please refer to the front of this catalogue or IC592 for stabilizer bar usage.









On-Module Channel Spacing

System 433

5' Ceiling Module

4" Channel
28" x 60" Infill Panel

Selector

Channel Width	Ceiling Module	On-Center Channel Spacing	Infill Panels	Panel Edge	Suspension System
4"	5' (60")	5' (60")	HALCYON 28" x 60" x 1"	FL 	DXT, DXI
				SL 	DX
				SQ 	DX
			MARS 28" x 60" x 3/4"	FLB 	DXT, DXI
				SLT 	DX
				SQ 	DX
			MARS High-NRC 28" x 60" x 7/8"	FLB 	DXT, DXI
				SLT 	DX
				SQ 	DX

Module Layout

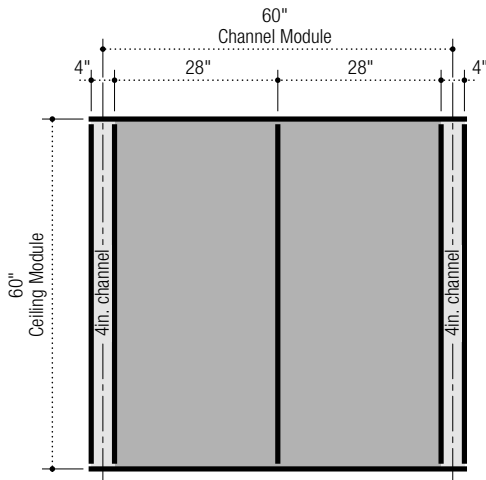

Panel Layout

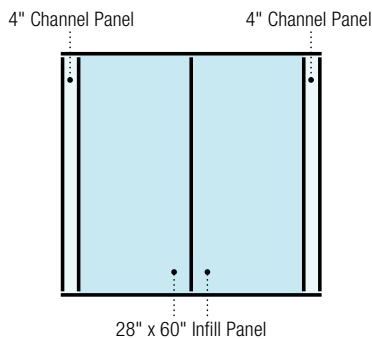

Suspension System Layout

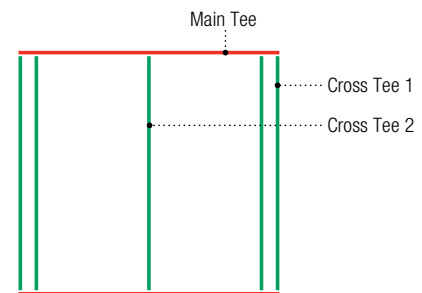

Order Information
System 433

5' Ceiling Module

4" Channel
28" x 60" Infill Panel

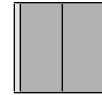

Step 1. Select Panels

Step 2. Select Edge for Panels

			FL/FLB		SL/SLT		SQ	
			Edge	Item No.	Edge	Item No.	Edge	Item No.
Infill Panels	HALCYON	28" x 60" x 1"	FL	<input type="checkbox"/> 97355	SL	<input type="checkbox"/> 97450	SQ	<input type="checkbox"/> 97420
	MARS	28" x 60" x 3/4"	FLB	<input type="checkbox"/> 86580	SLT	<input type="checkbox"/> 86560	SQ	<input type="checkbox"/> 86533
	MARS High-NRC	28" x 60" x 7/8"	FLB	<input type="checkbox"/> 86493	SLT	<input type="checkbox"/> 86461	SQ	<input type="checkbox"/> 86424

Channel Panels	HALCYON	4" x 60" x 1"	FL	<input type="checkbox"/> 97461	SL	<input type="checkbox"/> 97431	SQ	<input type="checkbox"/> 97403
	MARS	4" x 60" x 3/4"	FLB	<input type="checkbox"/> 86569	SLT	<input type="checkbox"/> 86541	SQ	<input type="checkbox"/> 86515
	MARS High-NRC	4" x 60" x 7/8"	FLB	<input type="checkbox"/> 86476	SLT	<input type="checkbox"/> 86441	SQ	<input type="checkbox"/> 86403

Step 3. Select Corresponding Grid for Selected Panels

			Qty	Item No.	Qty	Item No.	Qty	Item No.
Suspension Systems	CENTRICITEE DXT	Main Tee		<input type="checkbox"/> DXT24SP102				
		Cross Tee 1	2	<input type="checkbox"/> DXT524				
		Cross Tee 2	1	<input type="checkbox"/> DXT524				
	IDENTITEE DXI	Main Tee		<input type="checkbox"/> DXI24SP102				
		Cross Tee 1	2	<input type="checkbox"/> DXI524				
		Cross Tee 2	1	<input type="checkbox"/> DXI524				
	DONN DX	Main Tee			<input type="checkbox"/> DX24SP102		<input type="checkbox"/> DX24SP102	
		Cross Tee 1			2	<input type="checkbox"/> DX524	2	<input type="checkbox"/> DX524
		Cross Tee 2			1	<input type="checkbox"/> DX524	1	<input type="checkbox"/> DX524

Suspension System Estimator

	Length	Sq. Ft.	Main Tee Usage Per Sq. Ft.	Cross Tee 1 Usage Per Sq. Ft.	Cross Tee 2 Usage Per Sq. Ft.	
System Module	60"	25	0.20	0.40	0.20	

Note: Multiply the ceiling area (SF) by the Usage Factor (UF). This calculation will determine lineal footage of suspension system components required. Please refer to the front of this catalogue or IC592 for stabilizer bar usage.

On-Module Channel Spacing









System 524

4' Ceiling Module

4" Channel

56" x 30" Infill Panel

Selector

Channel Width	Ceiling Module	On-Center Channel Spacing	Infill Panels	Panel Edge	Suspension System	
4"	5' (60")	5' (60")	HALCYON	56" x 30" x 1"	FL 	DXT, DXI
					SL 	DX
					SQ 	DX
			MARS	56" x 30" x 3/4"	FLB 	DXT, DXI
					SLT 	DX
					SQ 	DX
			MARS High-NRC	56" x 30" x 7/8"	FLB 	DXT, DXI
					SLT 	DX
					SQ 	DX

Module Layout

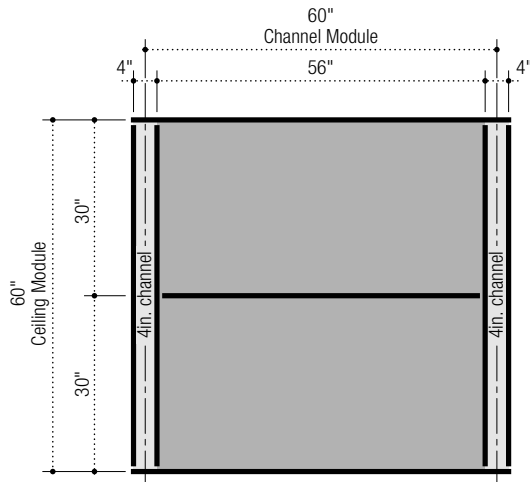

Panel Layout

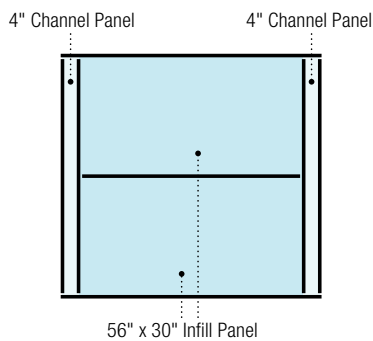

Suspension System Layout

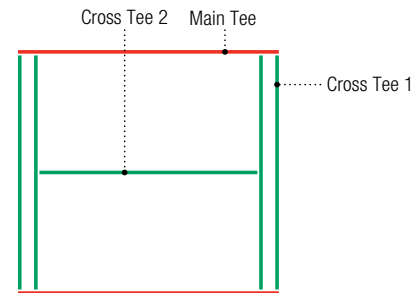

Order Information
System 524

5' Ceiling Module

4" Channel
56" x 30" Infill Panel



Step 1. Select Panels

Step 2. Select Edge for Panels

			FL/FLB		SL/SLT		SQ	
			Edge	Item No.	Edge	Item No.	Edge	Item No.
Infill Panels	HALCYON	56" x 30" x 1"	FL	<input type="checkbox"/> 97473	SL	<input type="checkbox"/> 97453	SQ	<input type="checkbox"/> 97423
	MARS	56" x 30" x 3/4"	FLB	<input type="checkbox"/> 86583	SLT	<input type="checkbox"/> 86563	SQ	<input type="checkbox"/> 86535
	MARS High-NRC	56" x 30" x 7/8"	FLB	<input type="checkbox"/> 86496	SLT	<input type="checkbox"/> 86465	SQ	<input type="checkbox"/> 86428

Channel Panels	HALCYON	4" x 60" x 1"	FL	<input type="checkbox"/> 97461	SL	<input type="checkbox"/> 97431	SQ	<input type="checkbox"/> 97403
	MARS	4" x 60" x 3/4"	FLB	<input type="checkbox"/> 86569	SLT	<input type="checkbox"/> 86541	SQ	<input type="checkbox"/> 86515
	MARS High-NRC	4" x 60" x 7/8"	FLB	<input type="checkbox"/> 86476	SLT	<input type="checkbox"/> 86441	SQ	<input type="checkbox"/> 86403

Step 3. Select Corresponding Grid for Selected Panels

			Qty	Item No.	Qty	Item No.	Qty	Item No.
Suspension Systems	CENTRICITEE DXT	Main Tee		<input type="checkbox"/> DXT24SP102				
		Cross Tee 1	2	<input type="checkbox"/> DXT524				
		Cross Tee 2	1	<input type="checkbox"/> DXT5622				
	IDENTITEE DXI	Main Tee		<input type="checkbox"/> DXI24SP102				
		Cross Tee 1	2	<input type="checkbox"/> DXI524				
		Cross Tee 2	1	<input type="checkbox"/> DXI5624				
	DONN DX	Main Tee			<input type="checkbox"/> DX24SP102		<input type="checkbox"/> DX24SP102	
		Cross Tee 1			2	<input type="checkbox"/> DX524	2	<input type="checkbox"/> DX524
		Cross Tee 2			1	<input type="checkbox"/> DX5616	1	<input type="checkbox"/> DX5616

Suspension System Estimator

	Length	Sq. Ft.	Main Tee Usage Per Sq. Ft.	Cross Tee 1 Usage Per Sq. Ft.	Cross Tee 2 Usage Per Sq. Ft.	
System Module	60"	25	0.20	0.40	0.19	

Note: Multiply the ceiling area (SF) by the Usage Factor (UF). This calculation will determine lineal footage of suspension system components required. Please refer to the front of this catalogue or IC592 for stabilizer bar usage.

On-Module Channel Spacing

4' Ceiling Module



4" Channel

System 795

46" x 48" Infill Panel

48" x 48" Infill Panel

Selector

Channel Width	Ceiling Module	On-Center Channel Spacing	Infill Panels	Panel Edge	Suspension System
4"	4' (48")	12' (144")	HALCYON 46" x 48" x 1" 48" x 48" x 1"	FL 	DXT, DXI
				SL 	DX
				SQ 	DX

Module Layout

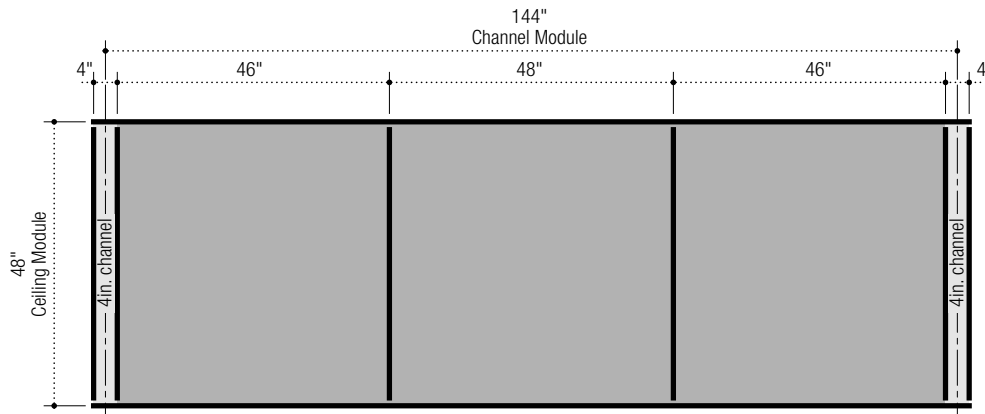

Panel Layout

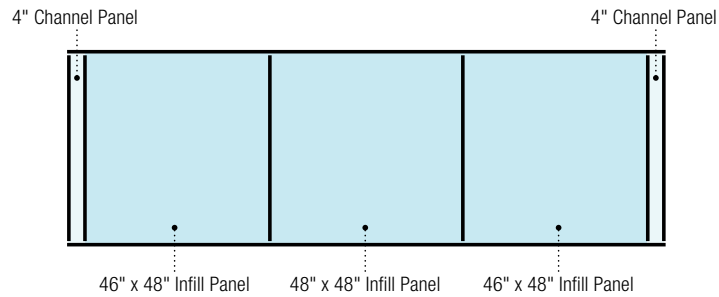

Suspension System Layout

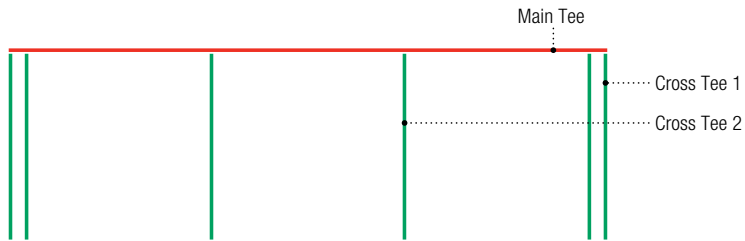

Order Information

System 795

4' Ceiling Module

4" Channel

46" x 48" Infill Panel

48" x 48" Infill Panel



Step 1. Select Panels

Step 2. Select Edge for Panels

			FL/FLB		SL/SLT		SQ	
			Edge	Item No.	Edge	Item No.	Edge	Item No.
Infill Panels	HALCYON	46" x 48" x 1"	FL	<input type="checkbox"/> 97477	SL	<input type="checkbox"/> 97457	SQ	<input type="checkbox"/> 97427

Channel Panels	HALCYON	4" x 48" x 1"	FL	<input type="checkbox"/> 97460	SL	<input type="checkbox"/> 97430	SQ	<input type="checkbox"/> 97402
-----------------------	---------	---------------	----	--------------------------------	----	--------------------------------	----	--------------------------------

Step 3. Select Corresponding Grid for Selected Panels

			Qty	Item No.	Qty	Item No.	Qty	Item No.
Suspension Systems	CENTRICITEE DXT	Main Tee		<input type="checkbox"/> DXT24SP104				
		Cross Tee 1	2	<input type="checkbox"/> DXT424				
		Cross Tee 2	2	<input type="checkbox"/> DXT424				
	IDENTITEE DXI	Main Tee		<input type="checkbox"/> DXI24SP104				
		Cross Tee 1	2	<input type="checkbox"/> DXI424				
		Cross Tee 2	2	<input type="checkbox"/> DXI424				
	DONN DX	Main Tee			<input type="checkbox"/> DX24SP104		<input type="checkbox"/> DX24SP104	
		Cross Tee 1			2	<input type="checkbox"/> DX422	2	<input type="checkbox"/> DX422
		Cross Tee 2			2	<input type="checkbox"/> DX422	2	<input type="checkbox"/> DX422

Suspension System Estimator

	Length	Sq. Ft.	Main Tee Usage Per Sq. Ft.	Cross Tee 1 Usage Per Sq. Ft.	Cross Tee 2 Usage Per Sq. Ft.	
System Module	144"	48	0.25	0.17	0.17	

Note: Multiply the ceiling area (SF) by the Usage Factor (UF). This calculation will determine lineal footage of suspension system components required. Please refer to the front of this catalogue or IC592 for stabilizer bar usage.

On-Module Channel Spacing



4' Ceiling Module

6" Channel

System 346

42" x 48" Infill Panel

Selector

Channel Width	Ceiling Module	On-Center Channel Spacing	Infill Panels	Panel Edge	Suspension System
6"	4' (48")	4' (48")	HALCYON 42" x 48" x 1"	FL  SL  SQ 	DXT, DXI DX DX

Module Layout

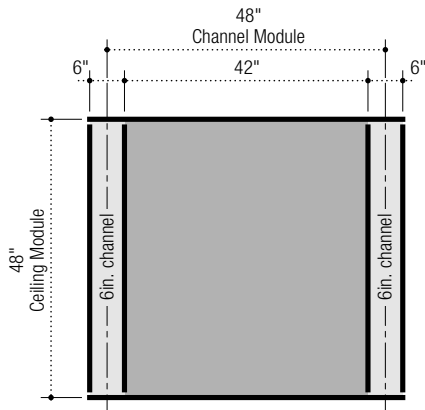

Panel Layout

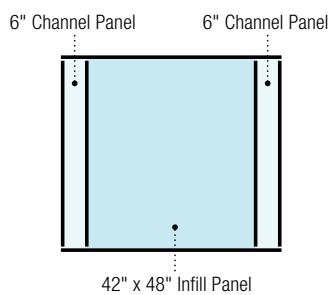

Suspension System Layout

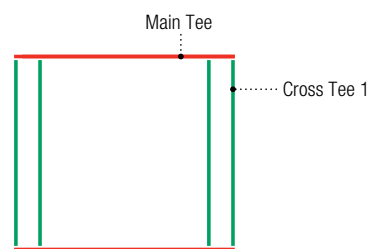

Order Information
System 346

4' Ceiling Module

6" Channel
42" x 48" Infill Panel



Step 1. Select Panels

Step 2. Select Edge for Panels

			FL/FLB		SL/SLT		SQ	
			Edge	Item No.	Edge	Item No.	Edge	Item No.
Infill Panels	HALCYON	42" x 48" x 1"	FL	<input type="checkbox"/> 98343	SL	<input type="checkbox"/> 97454	SQ	<input type="checkbox"/> 97424

Channel Panels	HALCYON	6" x 48" x 1"	FL	<input type="checkbox"/> 98198	SL	<input type="checkbox"/> 99271	SQ	<input type="checkbox"/> 97227
	PANZ Metal Panels, Solid	6" x 48"	FL	<input type="checkbox"/> 256820	SL	<input type="checkbox"/> 256819	SQ	<input type="checkbox"/> 256768
	Panz Metal Panels, Perf C116	6" x 48"	FL	<input type="checkbox"/> 256062	SL	<input type="checkbox"/> 257248	SQ	<input type="checkbox"/> 256397
	Panz Metal Panels, Perf C116D	6" x 48"	FL	<input type="checkbox"/> 257585	SL	<input type="checkbox"/> 257584	SQ	<input type="checkbox"/> 257406

Step 3. Select Corresponding Grid for Selected Panels

			Qty	Item No.	Qty	Item No.	Qty	Item No.
Suspension Systems	CENTRICITEE DXT	Main Tee		<input type="checkbox"/> DXT24				
		Cross Tee 1	2	<input type="checkbox"/> DXT424				
	IDENTITEE DXI	Main Tee		<input type="checkbox"/> DXI24				
		Cross Tee 1	2	<input type="checkbox"/> DXI424				
	DONN DX	Main Tee				<input type="checkbox"/> DX/DXL24		<input type="checkbox"/> DX/DXL24
		Cross Tee 1			2	<input type="checkbox"/> DX422	2	<input type="checkbox"/> DX422

Suspension System Estimator

	Length	Sq. Ft.	Main Tee Usage Per Sq. Ft.	Cross Tee 1 Usage Per Sq. Ft.	
System Module	48"	16	0.25	0.50	

Note: Multiply the ceiling area (SF) by the Usage Factor (UF). This calculation will determine lineal footage of suspension system components required. Please refer to the front of this catalogue or IC592 for stabilizer bar usage.

On-Module Channel Spacing









4' Ceiling Module

6" Channel

System 727

42" x 24" Infill Panel

Selector

Channel Width	Ceiling Module	On-Center Channel Spacing	Infill Panels	Panel Edge	Suspension System	
6"	4' (60")	4' (60")	HALCYON	42" x 24" x 1"	FL 	DXT, DXI
					SL 	DX
					SQ 	DX
			MARS	42" x 24" x 3/4"	FLB 	DXT, DXI
					SLT 	DX
					SQ 	DX
			MARS High-NRC	42" x 24" x 7/8"	FLB 	DXT, DXI
					SLT 	DX
					SQ 	DX

Module Layout

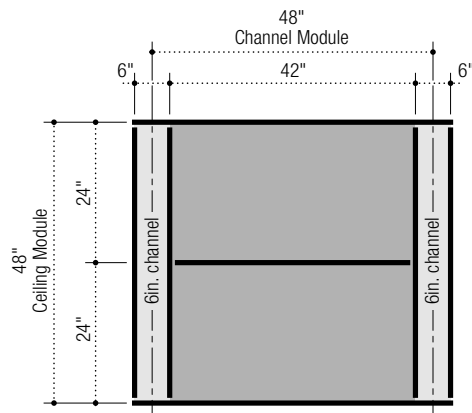

Panel Layout

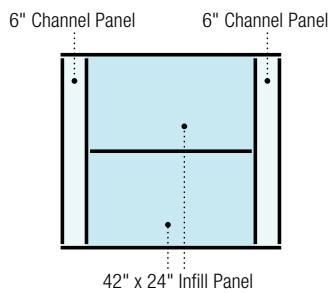

Suspension System Layout

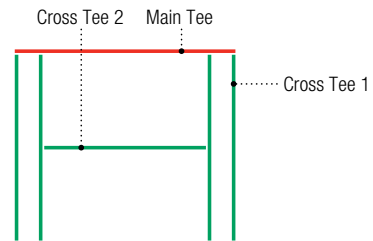

Order Information
System 727

4' Ceiling Module

6" Channel
42" x 24" Infill Panel



Step 1. Select Panels

Step 2. Select Edge for Panels

			FL/FLB		SL/SLT		SQ	
			Edge	Item No.	Edge	Item No.	Edge	Item No.
Infill Panels	HALCYON	42" x 24" x 1"	FL	<input type="checkbox"/> 98196	SL	<input type="checkbox"/> 97443	SQ	<input type="checkbox"/> 97277
	MARS	42" x 24" x 3/4"	FLB	<input type="checkbox"/> 86577	SLT	<input type="checkbox"/> 86555	SQ	<input type="checkbox"/> 86527
	MARS High-NRC	42" x 24" x 7/8"	FLB	<input type="checkbox"/> 86488	SLT	<input type="checkbox"/> 86456	SQ	<input type="checkbox"/> 86419

Channel Panels	HALCYON	6" x 48" x 1"	FL	<input type="checkbox"/> 98198	SL	<input type="checkbox"/> 99271	SQ	<input type="checkbox"/> 97227
	MARS	6" x 48" x 3/4"	FLB	<input type="checkbox"/> 88887	SLT	<input type="checkbox"/> 86542	SQ	<input type="checkbox"/> 86325
	MARS High-NRC	6" x 48" x 7/8"	FLB	<input type="checkbox"/> 86331	SLT	<input type="checkbox"/> 86442	SQ	<input type="checkbox"/> 86404
	Panz Metal Panels, Solid	6" x 48"	FL	<input type="checkbox"/> 256820	SL	<input type="checkbox"/> 256819	SQ	<input type="checkbox"/> 256768
	Panz Metal Panels, Perf C116	6" x 48"	FL	<input type="checkbox"/> 256062	SL	<input type="checkbox"/> 257248	SQ	<input type="checkbox"/> 256397
	Panz Metal Panels, Perf C116D	6" x 48"	FL	<input type="checkbox"/> 257585	SL	<input type="checkbox"/> 257584	SQ	<input type="checkbox"/> 257406

Step 3. Select Corresponding Grid for Selected Panels

			Qty	Item No.	Qty	Item No.	Qty	Item No.
Suspension Systems	CENTRICITEE DXT	Main Tee		<input type="checkbox"/> DXT24				
		Cross Tee 1	2	<input type="checkbox"/> DXT424				
		Cross Tee 2	1	<input type="checkbox"/> DXT4224				
	IDENTITEE DXI	Main Tee		<input type="checkbox"/> DXI24				
		Cross Tee 1	2	<input type="checkbox"/> DXI424				
		Cross Tee 2	1	<input type="checkbox"/> DXI4224				
	DONN DX	Main Tee			<input type="checkbox"/> DX/DXL24		<input type="checkbox"/> DX/DXL24	
		Cross Tee 1			2	<input type="checkbox"/> DX422	2	<input type="checkbox"/> DX422
		Cross Tee 2			1	<input type="checkbox"/> DX4224	1	<input type="checkbox"/> DX4224

Suspension System Estimator

	Length	Sq. Ft.	Main Tee Usage Per Sq. Ft.	Cross Tee 1 Usage Per Sq. Ft.	Cross Tee 2 Usage Per Sq. Ft.	
System Module	48"	16	0.25	0.50	0.22	

Note: Multiply the ceiling area (SF) by the Usage Factor (UF). This calculation will determine lineal footage of suspension system components required. Please refer to the front of this catalogue or IC592 for stabilizer bar usage.

On-Module Channel Spacing









4' Ceiling Module

6" Channel

System 838

21" x 24" Infill Panel

Selector

Channel Width	Ceiling Module	On-Center Channel Spacing	Infill Panels	Panel Edge	Suspension System
6"	4' (48")	4' (48")	HALCYON 21" x 24" x 1"	FL 	DXT, DXI
				SL 	DX
				SQ 	DX, DXT
			MARS 21" x 24" x 3/4"	FLB 	DXT, DXI
				SLT 	DX
				SQ 	DX, DXT
			MARS High-NRC 21" x 24" x 7/8"	FLB 	DXT, DXI
				SLT 	DX
				SQ 	DX, DXT

Module Layout

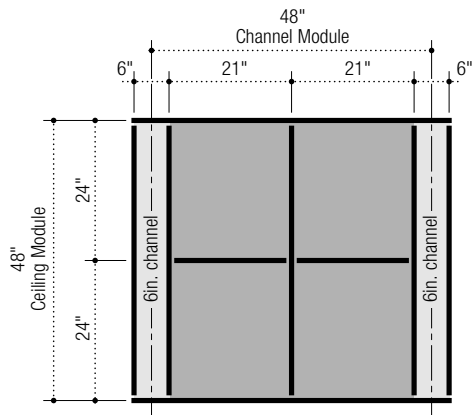

Panel Layout

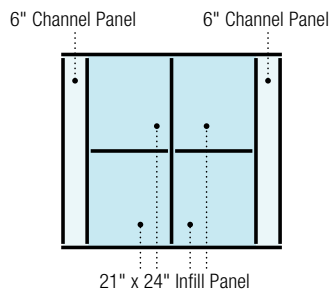

Suspension System Layout

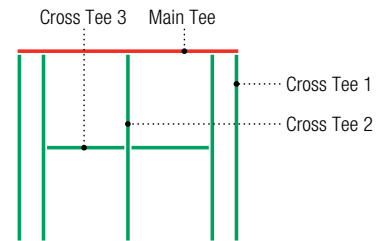

Order Information
System 838

4' Ceiling Module

6" Channel
21" x 24" Infill Panel



Step 1. Select Panels

Step 2. Select Edge for Panels

			FL/FLB		SL/SLT		SQ	
			Edge	Item No.	Edge	Item No.	Edge	Item No.
Infill Panels	HALCYON	21" x 24" x 1"	FL	<input type="checkbox"/> 98195	SL	<input type="checkbox"/> 98220	SQ	<input type="checkbox"/> 97411
	MARS	21" x 24" x 3/4"	FLB	<input type="checkbox"/> 88840	SLT	<input type="checkbox"/> 86550	SQ	<input type="checkbox"/> 86522
	MARS High-NRC	21" x 24" x 7/8"	FLB	<input type="checkbox"/> 86483	SLT	<input type="checkbox"/> 86451	SQ	<input type="checkbox"/> 86414

Channel Panels	HALCYON	6" x 48" x 1"	FL	<input type="checkbox"/> 98198	SL	<input type="checkbox"/> 99271	SQ	<input type="checkbox"/> 97227
	MARS	6" x 48" x 3/4"	FLB	<input type="checkbox"/> 88887	SLT	<input type="checkbox"/> 86542	SQ	<input type="checkbox"/> 86325
	MARS High-NRC	6" x 48" x 7/8"	FLB	<input type="checkbox"/> 86331	SLT	<input type="checkbox"/> 86442	SQ	<input type="checkbox"/> 86404
	PANZ Metal Panels, Solid	6" x 48"	FL	<input type="checkbox"/> 256820	SL	<input type="checkbox"/> 256819	SQ	<input type="checkbox"/> 256768
	Panz Metal Panels, Perf C116	6" x 48"	FL	<input type="checkbox"/> 256062	SL	<input type="checkbox"/> 257248	SQ	<input type="checkbox"/> 256397
	Panz Metal Panels, Perf C116D	6" x 48"	FL	<input type="checkbox"/> 257585	SL	<input type="checkbox"/> 257584	SQ	<input type="checkbox"/> 257406

Step 3. Select Corresponding Grid for Selected Panels

			Qty	Item No.	Qty	Item No.	Qty	Item No.
Suspension Systems	CENTRICITEE DXT	Main Tee		<input type="checkbox"/> DXT24SP105				<input type="checkbox"/> DXT24SP105
		Cross Tee 1	2	<input type="checkbox"/> DXT424			2	<input type="checkbox"/> DXT424
		Cross Tee 2	1	<input type="checkbox"/> DXT424			1	<input type="checkbox"/> DXT424
		Cross Tee 3	2	<input type="checkbox"/> DXT2122			2	<input type="checkbox"/> DXT2122
	IDENTITEE DXI	Main Tee		<input type="checkbox"/> DXI24SP105				
		Cross Tee 1	2	<input type="checkbox"/> DXI424				
		Cross Tee 2	1	<input type="checkbox"/> DXI424				
		Cross Tee 3	2	<input type="checkbox"/> DXI2122				
	DONN DX	Main Tee				<input type="checkbox"/> DX24SP105		<input type="checkbox"/> DX24SP105
		Cross Tee 1			2	<input type="checkbox"/> DX422	2	<input type="checkbox"/> DX422
		Cross Tee 2			1	<input type="checkbox"/> DX422	1	<input type="checkbox"/> DX
		Cross Tee 3			2	<input type="checkbox"/> DX2116	2	<input type="checkbox"/> DX2116

Suspension System Estimator

	Length	Sq. Ft.	Main Tee Usage Per Sq. Ft.	Cross Tee 1 Usage Per Sq. Ft.	Cross Tee 2 Usage Per Sq. Ft.	Cross Tee 3 Usage Per Sq. Ft.
System Module	48"	16	0.25	0.50	0.25	0.22

Note: Multiply the ceiling area (SF) by the Usage Factor (UF). This calculation will determine lineal footage of suspension system components required. Please refer to the front of this catalogue or IC592 for stabilizer bar usage.

On-Module Channel Spacing









4' Ceiling Module

6" Channel

System 646

21" x 48" Infill Panel

Selector

Channel Width	Ceiling Module	On-Center Channel Spacing	Infill Panels	Panel Edge	Suspension System
4"	4' (48")	4' (48")	HALCYON 21" x 48" x 1"	FL 	DXT, DXI
				SL 	DX
				SQ 	DX
			MARS 21" x 48 x 3/4"	FLB 	DXT, DXI
				SLT 	DX
				SQ 	DX
			MARS High-NRC 21" x 48" x 7/8"	FLB 	DXT, DXI
				SLT 	DX
				SQ 	DX

Module Layout

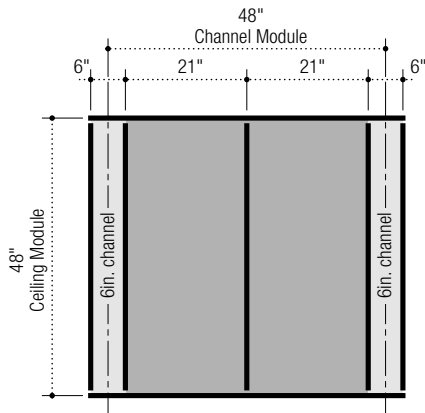

Panel Layout

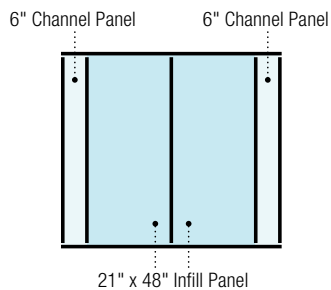

Suspension System Layout

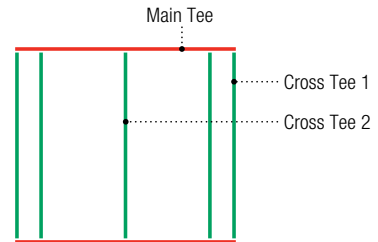

Order Information
System 646

4' Ceiling Module

6" Channel
21" x 48" Infill Panel



Step 1. Select Panels

Step 2. Select Edge for Panels

			FL/FLB		SL/SLT		SQ	
			Edge	Item No.	Edge	Item No.	Edge	Item No.
Infill Panels	HALCYON	21" x 48" x 1"	FL	<input type="checkbox"/> 97466	SL	<input type="checkbox"/> 97439	SQ	<input type="checkbox"/> 97412
	MARS	21" x 48" x 3/4"	FLB	<input type="checkbox"/> 86573	SLT	<input type="checkbox"/> 86551	SQ	<input type="checkbox"/> 86523
	MARS High-NRC	21" x 48" x 7/8"	FLB	<input type="checkbox"/> 86484	SLT	<input type="checkbox"/> 86452	SQ	<input type="checkbox"/> 86415

Channel Panels	HALCYON	6" x 48" x 1"	FL	<input type="checkbox"/> 98198	SL	<input type="checkbox"/> 99271	SQ	<input type="checkbox"/> 97227
	MARS	6" x 48" x 3/4"	FLB	<input type="checkbox"/> 88887	SLT	<input type="checkbox"/> 86542	SQ	<input type="checkbox"/> 86325
	MARS High-NRC	6" x 48" x 7/8"	FLB	<input type="checkbox"/> 86331	SLT	<input type="checkbox"/> 86442	SQ	<input type="checkbox"/> 86404
	Panz Metal Panels, Solid	6" x 48"	FL	<input type="checkbox"/> 256820	SL	<input type="checkbox"/> 256819	SQ	<input type="checkbox"/> 256768
	Panz Metal Panels, Perf C116	6" x 48"	FL	<input type="checkbox"/> 256062	SL	<input type="checkbox"/> 257248	SQ	<input type="checkbox"/> 256397
	Panz Metal Panels, Perf C116D	6" x 48"	FL	<input type="checkbox"/> 257585	SL	<input type="checkbox"/> 257584	SQ	<input type="checkbox"/> 257406

Step 3. Select Corresponding Grid for Selected Panels

			Qty	Item No.	Qty	Item No.	Qty	Item No.
Suspension Systems	CENTRICITEE DXT	Main Tee		<input type="checkbox"/> DXT24SP105				
		Cross Tee 1	2	<input type="checkbox"/> DXT424				
		Cross Tee 2	1	<input type="checkbox"/> DXT424				
	IDENTITEE DXI	Main Tee		<input type="checkbox"/> DXI24SP105				
		Cross Tee 1	2	<input type="checkbox"/> DXI424				
		Cross Tee 2	1	<input type="checkbox"/> DXI424				
	DONN DX	Main Tee			<input type="checkbox"/> DX24SP105		<input type="checkbox"/> DX24SP105	
		Cross Tee 1			2	<input type="checkbox"/> DX422	2	<input type="checkbox"/> DX422
		Cross Tee 2			1	<input type="checkbox"/> DX422	1	<input type="checkbox"/> DX422

Suspension System Estimator

	Length	Sq. Ft.	Main Tee Usage Per Sq. Ft.	Cross Tee 1 Usage Per Sq. Ft.	Cross Tee 2 Usage Per Sq. Ft.	
System Module	48"	16	0.25	0.50	0.25	

Note: Multiply the ceiling area (SF) by the Usage Factor (UF). This calculation will determine lineal footage of suspension system components required. Please refer to the front of this catalogue or IC592 for stabilizer bar usage.

On-Module Channel Spacing



4' Ceiling Module

6" Channel

System 363

54" x 48" Infill Panel

Selector

Channel Width	Ceiling Module	On-Center Channel Spacing	Infill Panels	Panel Edge	Suspension System
6"	4' (48")	5' (60")	HALCYON 54" x 48" x 1"	FL 	DXT, DXI
				SL 	DX
				SQ 	DX

Module Layout

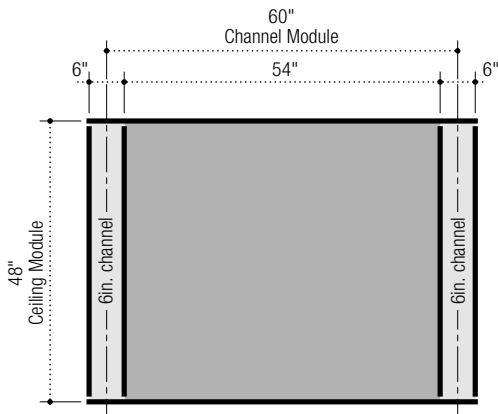

Panel Layout

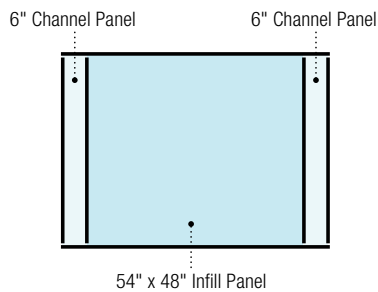

Suspension System Layout

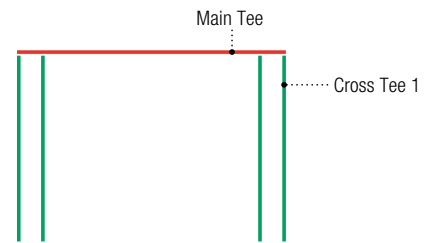

Order Information
System 363

4' Ceiling Module

6" Channel
54" x 48" Infill Panel



Step 1. Select Panels

Step 2. Select Edge for Panels

			FL/FLB		SL/SLT		SQ	
			Edge	Item No.	Edge	Item No.	Edge	Item No.
Infill Panels	HALCYON	54" x 48" x 1"	FL	<input type="checkbox"/> 98344	SL	<input type="checkbox"/> 97458	SQ	<input type="checkbox"/> 97428

Channel Panels	HALCYON	6" x 48" x 1"	FL	<input type="checkbox"/> 98198	SL	<input type="checkbox"/> 99271	SQ	<input type="checkbox"/> 97227
	PANZ Metal Panels, Solid	6" x 48"	FL	<input type="checkbox"/> 256820	SL	<input type="checkbox"/> 256819	SQ	<input type="checkbox"/> 256768
	Panz Metal Panels, Perf C116	6" x 48"	FL	<input type="checkbox"/> 256062	SL	<input type="checkbox"/> 257248	SQ	<input type="checkbox"/> 256397
	Panz Metal Panels, Perf C116D	6" x 48"	FL	<input type="checkbox"/> 257585	SL	<input type="checkbox"/> 257584	SQ	<input type="checkbox"/> 257406

Step 3. Select Corresponding Grid for Selected Panels

			Qty	Item No.	Qty	Item No.	Qty	Item No.
Suspension Systems	CENTRICITEE DXT	Main Tee		<input type="checkbox"/> DXT24				
		Cross Tee 1	2	<input type="checkbox"/> DXT424				
	IDENTITEE DXI	Main Tee		<input type="checkbox"/> DXI24				
		Cross Tee 1	2	<input type="checkbox"/> DXI424				
	DONN DX	Main Tee				<input type="checkbox"/> DX/DXL24		<input type="checkbox"/> DX/DXL24
		Cross Tee 1			2	<input type="checkbox"/> DX422	2	<input type="checkbox"/> DX422

Suspension System Estimator

	Length	Sq. Ft.	Main Tee Usage Per Sq. Ft.	Cross Tee 1 Usage Per Sq. Ft.	
System Module	60"	20	0.25	0.40	

Note: Multiply the ceiling area (SF) by the Usage Factor (UF). This calculation will determine lineal footage of suspension system components required. Please refer to the front of this catalogue or IC592 for stabilizer bar usage.

On-Module Channel Spacing









5' Ceiling Module

6" Channel

System 753

54" x 20" Infill Panel

Selector

Channel Width	Ceiling Module	On-Center Channel Spacing	Infill Panels	Panel Edge	Suspension System
6"	5' (60")	5' (60")	HALCYON 54" x 20" x 1"	FL 	DXT, DXI
				SL 	DX
				SQ 	DX
			MARS 54" x 20" x 3/4"	FLB 	DXT, DXI
				SLT 	DX
				SQ 	DX
			MARS High-NRC 54" x 20" x 7/8"	FLB 	DXT, DXI
				SLT 	DX
				SQ 	DX

Module Layout

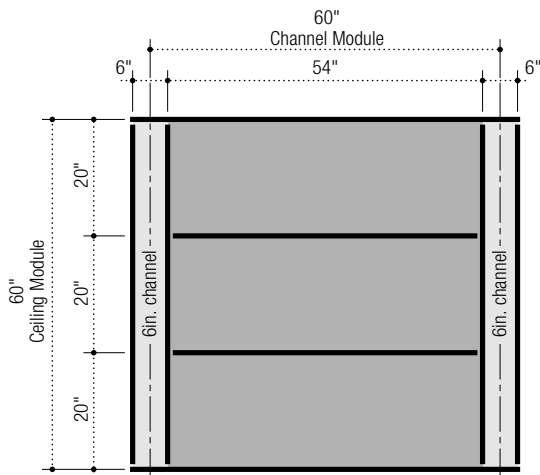

Panel Layout

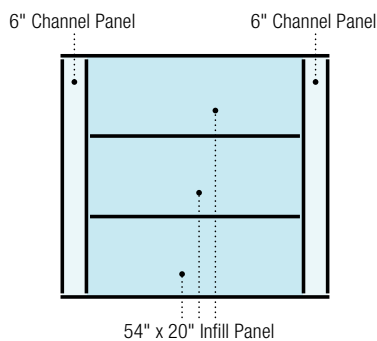

Suspension System Layout

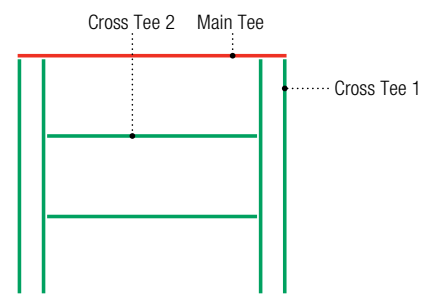

Order Information
System 753

5' Ceiling Module

6" Channel
54" x 20" Infill Panel



Step 1. Select Panels

Step 2. Select Edge for Panels

			FL/FLB		SL/SLT		SQ	
			Edge	Item No.	Edge	Item No.	Edge	Item No.
Infill Panels	HALCYON	54" x 20" x 1"	FL	<input type="checkbox"/> 98360	SL	<input type="checkbox"/> 97436	SQ	<input type="checkbox"/> 97407
	MARS	54" x 20" x 3/4"	FLB	<input type="checkbox"/> 88845	SLT	<input type="checkbox"/> 86547	SQ	<input type="checkbox"/> 86519
	MARS High-NRC	54" x 20" x 7/8"	FLB	<input type="checkbox"/> 86479	SLT	<input type="checkbox"/> 86447	SQ	<input type="checkbox"/> 86410

Channel Panels	HALCYON	6" x 60" x 1"	FL	<input type="checkbox"/> 98199	SL	<input type="checkbox"/> 99272	SQ	<input type="checkbox"/> 97228
	MARS	6" x 60" x 3/4"	FLB	<input type="checkbox"/> 86835	SLT	<input type="checkbox"/> 86543	SQ	<input type="checkbox"/> 86507
	MARS High-NRC	6" x 60" x 7/8"	FLB	<input type="checkbox"/> 86333	SLT	<input type="checkbox"/> 86443	SQ	<input type="checkbox"/> 86145
	PANZ Metal Panels, Solid	6" x 60"	FL	<input type="checkbox"/> 258036	SL	<input type="checkbox"/> 257972	SQ	<input type="checkbox"/> 257586
	Panz Metal Panels, Perf C116	6" x 60"	FL	<input type="checkbox"/> 259228	SL	<input type="checkbox"/> 259010	SQ	<input type="checkbox"/> 259009
	Panz Metal Panels, Perf C116D	6" x 60"	FL	<input type="checkbox"/> 259353	SL	<input type="checkbox"/> 259344	SQ	<input type="checkbox"/> 259308

Step 3. Select Corresponding Grid for Selected Panels

			Qty	Item No.	Qty	Item No.	Qty	Item No.
Suspension Systems	CENTRICITEE DXT	Main Tee		<input type="checkbox"/> DXT24				
		Cross Tee 1	2	<input type="checkbox"/> DXT524				
	IDENTITEE DXI	Main Tee		<input type="checkbox"/> DXI24				
		Cross Tee 1	2	<input type="checkbox"/> DXI524				
	DONN DX	Main Tee				<input type="checkbox"/> DX/DXL24		<input type="checkbox"/> DX/DXL24
		Cross Tee 1			2	<input type="checkbox"/> DX524	2	<input type="checkbox"/> DX524

Suspension System Estimator

	Length	Sq. Ft.	Main Tee Usage Per Sq. Ft.	Cross Tee 1 Usage Per Sq. Ft.	
System Module	60"	20	0.25	0.40	

Note: Multiply the ceiling area (SF) by the Usage Factor (UF). This calculation will determine lineal footage of suspension system components required. Please refer to the front of this catalogue or IC592 for stabilizer bar usage.

On-Module Channel Spacing









5' Ceiling Module

6" Channel

System 856

27" x 30" Infill Panel

Selector

Channel Width	Ceiling Module	On-Center Channel Spacing	Infill Panels	Panel Edge	Suspension System
6"	5' (60")	5' (60")	HALCYON 27" x 30" x 1"	FL 	DXT, DXI
				SL 	DX
				SQ 	DX
			MARS 27" x 30" x 3/4"	FLB 	DXT, DXI
				SLT 	DX
				SQ 	DX
			MARS High-NRC 27" x 30" x 7/8"	FLB 	DXT, DXI
				SLT 	DX
				SQ 	DX

Module Layout

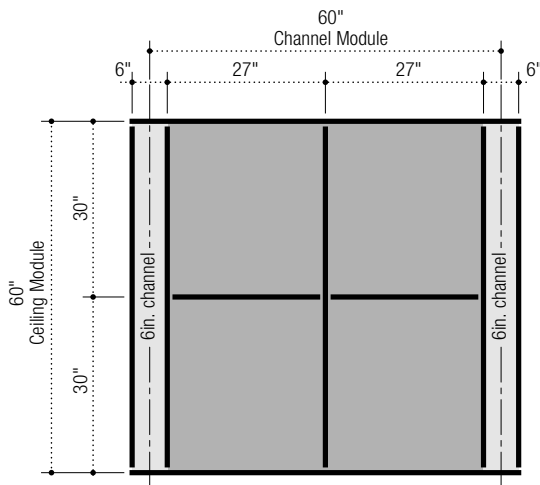

Panel Layout

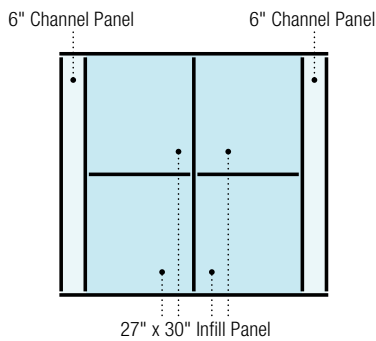

Suspension System Layout

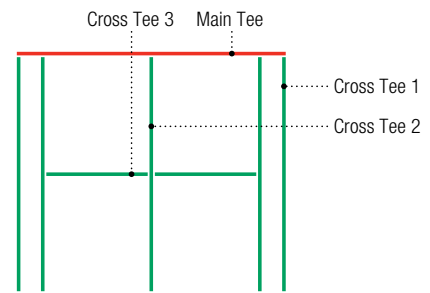

Order Information
System 856

5' Ceiling Module

6" Channel
27" x 30" Infill Panel

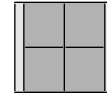

Step 1. Select Panels

Step 2. Select Edge for Panels

			FL/FLB		SL/SLT		SQ	
			Edge	Item No.	Edge	Item No.	Edge	Item No.
Infill Panels	HALCYON	27" x 30" x 1"	FL	<input type="checkbox"/> 97333	SL	<input type="checkbox"/> 97477	SQ	<input type="checkbox"/> 97417
	MARS	27" x 30" x 3/4"	FLB	<input type="checkbox"/> 86850	SLT	<input type="checkbox"/> 86557	SQ	<input type="checkbox"/> 86530
	MARS High-NRC	27" x 30" x 7/8"	FLB	<input type="checkbox"/> 86490	SLT	<input type="checkbox"/> 86458	SQ	<input type="checkbox"/> 86421

Channel Panels	HALCYON	6" x 60" x 1"	FL	<input type="checkbox"/> 98199	SL	<input type="checkbox"/> 99272	SQ	<input type="checkbox"/> 97228
	MARS	6" x 60" x 3/4"	FLB	<input type="checkbox"/> 86835	SLT	<input type="checkbox"/> 86543	SQ	<input type="checkbox"/> 86507
	MARS High-NRC	6" x 60" x 7/8"	FLB	<input type="checkbox"/> 86333	SLT	<input type="checkbox"/> 86443	SQ	<input type="checkbox"/> 86145
	PANZ Metal Panels, Solid	6" x 60"	FL	<input type="checkbox"/> 258036	SL	<input type="checkbox"/> 257972	SQ	<input type="checkbox"/> 257586
	Panz Metal Panels, Perf C116	6" x 60"	FL	<input type="checkbox"/> 259228	SL	<input type="checkbox"/> 259010	SQ	<input type="checkbox"/> 259009
	Panz Metal Panels, Perf C116D	6" x 60"	FL	<input type="checkbox"/> 259353	SL	<input type="checkbox"/> 259344	SQ	<input type="checkbox"/> 259308

Step 3. Select Corresponding Grid for Selected Panels

			Qty	Item No.	Qty	Item No.	Qty	Item No.
Suspension Systems	CENTRICITEE DXT	Main Tee		<input type="checkbox"/> DXT24SP109				
		Cross Tee 1	2	<input type="checkbox"/> DXT524				
		Cross Tee 2	1	<input type="checkbox"/> DXT524				
		Cross Tee 3	2	<input type="checkbox"/> DXT2722				
	IDENTITEE DXI	Main Tee		<input type="checkbox"/> DXI24SP109				
		Cross Tee 1	2	<input type="checkbox"/> DXI524				
		Cross Tee 2	1	<input type="checkbox"/> DXI524				
		Cross Tee 3	2	<input type="checkbox"/> DXI2724				
	DONN DX	Main Tee			<input type="checkbox"/> DX24SP109		<input type="checkbox"/> DX24SP109	
		Cross Tee 1			2	<input type="checkbox"/> DX524	2	<input type="checkbox"/> DX524
		Cross Tee 2			1	<input type="checkbox"/> DX524	1	<input type="checkbox"/> DX524
		Cross Tee 3			2	<input type="checkbox"/> DX2716	2	<input type="checkbox"/> DX2716

Suspension System Estimator

	Length	Sq. Ft.	Main Tee Usage Per Sq. Ft.	Cross Tee 1 Usage Per Sq. Ft.	Cross Tee 2 Usage Per Sq. Ft.	Cross Tee 3 Usage Per Sq. Ft.
System Module	60"	25	0.20	0.40	0.20	0.18

Note: Multiply the ceiling area (SF) by the Usage Factor (UF). This calculation will determine lineal footage of suspension system components required. Please refer to the front of this catalogue or IC592 for stabilizer bar usage.

On-Module Channel Spacing









5' Ceiling Module

6" Channel

System 343

27" x 60" Infill Panel

Selector

Channel Width	Ceiling Module	On-Center Channel Spacing	Infill Panels	Panel Edge	Suspension System
6"	5' (60")	5' (60")	HALCYON 27" x 60" x 1"	FL 	DXT, DXI
				SL 	DX
				SQ 	DX
			MARS 27" x 60" x 3/4"	FLB 	DXT, DXI
				SLT 	DX
				SQ 	DX
			MARS High-NRC 27" x 60" x 7/8"	FLB 	DXT, DXI
				SLT 	DX
				SQ 	DX

Module Layout

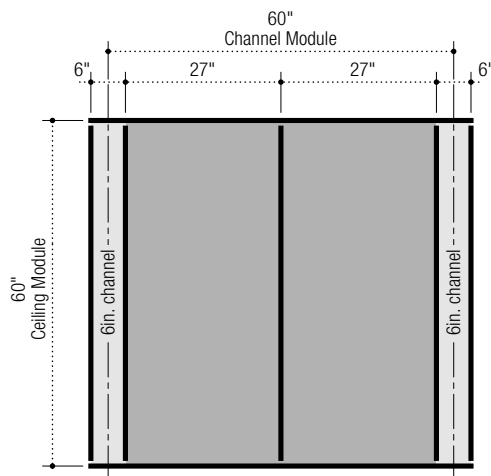

Panel Layout

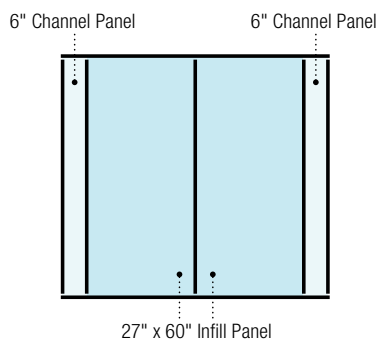

Suspension System Layout

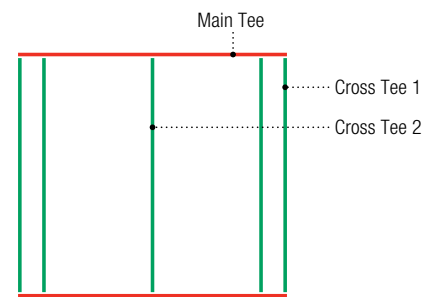

Order Information
System 343

5' Ceiling Module

6" Channel
27" x 60" Infill Panel

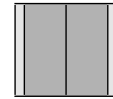

Step 1. Select Panels

Step 2. Select Edge for Panels

			FL/FLB		SL/SLT		SQ	
			Edge	Item No.	Edge	Item No.	Edge	Item No.
Infill Panels	HALCYON	27" x 60" x 1"	FL	<input type="checkbox"/> 98440	SL	<input type="checkbox"/> 97448	SQ	<input type="checkbox"/> 97418
	MARS	27" x 60" x 3/4"	FLB	<input type="checkbox"/> 86579	SLT	<input type="checkbox"/> 86558	SQ	<input type="checkbox"/> 86531
	MARS High-NRC	27" x 60" x 7/8"	FLB	<input type="checkbox"/> 86491	SLT	<input type="checkbox"/> 86460	SQ	<input type="checkbox"/> 86422

Channel Panels	HALCYON	6" x 60" x 1"	FL	<input type="checkbox"/> 98199	SL	<input type="checkbox"/> 99272	SQ	<input type="checkbox"/> 97228
	MARS	6" x 60" x 3/4"	FLB	<input type="checkbox"/> 86835	SLT	<input type="checkbox"/> 86543	SQ	<input type="checkbox"/> 86507
	MARS High-NRC	6" x 60" x 7/8"	FLB	<input type="checkbox"/> 86333	SLT	<input type="checkbox"/> 86443	SQ	<input type="checkbox"/> 86145
	Panz Metal Panels, Solid	6" x 60"	FL	<input type="checkbox"/> 258036	SL	<input type="checkbox"/> 257972	SQ	<input type="checkbox"/> 257586
	Panz Metal Panels, Perf C116	6" x 60"	FL	<input type="checkbox"/> 259228	SL	<input type="checkbox"/> 259010	SQ	<input type="checkbox"/> 259009
	Panz Metal Panels, Perf C116D	6" x 60"	FL	<input type="checkbox"/> 259353	SL	<input type="checkbox"/> 259344	SQ	<input type="checkbox"/> 259308

Step 3. Select Corresponding Grid for Selected Panels

			Qty	Item No.	Qty	Item No.	Qty	Item No.
Suspension Systems	CENTRICITEE DXT	Main Tee		<input type="checkbox"/> DXT24SP109				
		Cross Tee 1	2	<input type="checkbox"/> DXT524				
		Cross Tee 2	1	<input type="checkbox"/> DXT524				
	IDENTITEE DXI	Main Tee		<input type="checkbox"/> DXI24SP109				
		Cross Tee 1	2	<input type="checkbox"/> DXI524				
		Cross Tee 2	1	<input type="checkbox"/> DXI524				
	DONN DX	Main Tee			<input type="checkbox"/> DX24SP109		<input type="checkbox"/> DX24SP109	
		Cross Tee 1			2	<input type="checkbox"/> DX524	2	<input type="checkbox"/> DX524
		Cross Tee 2			1	<input type="checkbox"/> DX524	1	<input type="checkbox"/> DX524

Suspension System Estimator

	Length	Sq. Ft.	Main Tee Usage Per Sq. Ft.	Cross Tee 1 Usage Per Sq. Ft.	Cross Tee 2 Usage Per Sq. Ft.	
System Module	60"	25	0.20	0.40	0.20	

Note: Multiply the ceiling area (SF) by the Usage Factor (UF). This calculation will determine lineal footage of suspension system components required. Please refer to the front of this catalogue or IC592 for stabilizer bar usage.

On-Module Channel Spacing









4' Ceiling Module

4" Channel

System 865

54" x 30" Infill Panel

Selector

Channel Width	Ceiling Module	On-Center Channel Spacing	Infill Panels	Panel Edge	Suspension System	
6"	5' (60")	5' (60")	HALCYON	54" x 30" x 1"	FL 	DXT, DXI
					SL 	DX
					SQ 	DX
			MARS	54" x 30" x 3/4"	FLB 	DXT, DXI
					SLT 	DX
					SQ 	DX
			MARS High-NRC	54" x 30" x 7/8"	FLB 	DXT, DXI
					SLT 	DX
					SQ 	DX

Module Layout

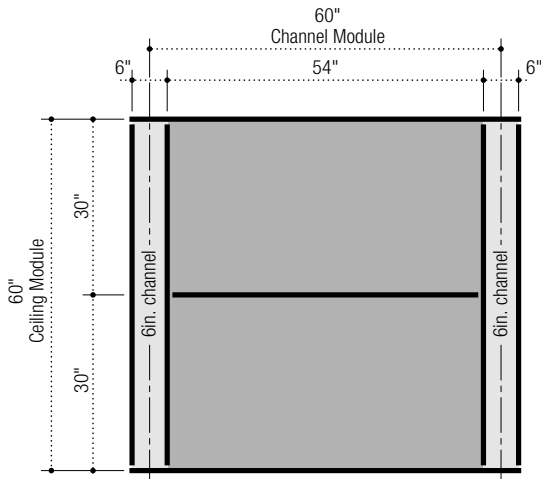

Panel Layout

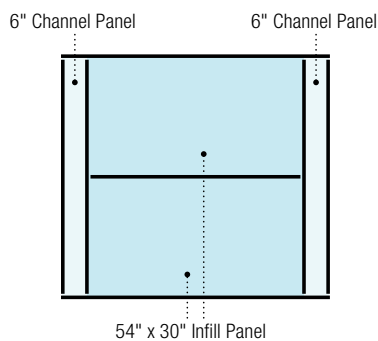

Suspension System Layout

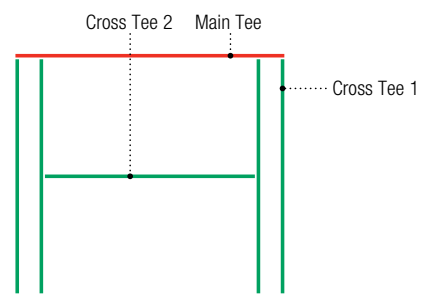

Order Information
System 865

5' Ceiling Module

6" Channel
54" x 30" Infill Panel

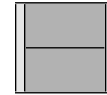

Step 1. Select Panels

Step 2. Select Edge for Panels

			FL/FLB		SL/SLT		SQ	
			Edge	Item No.	Edge	Item No.	Edge	Item No.
Infill Panels	HALCYON	54" x 30" x 1"	FL	<input type="checkbox"/> 98359	SL	<input type="checkbox"/> 98337	SQ	<input type="checkbox"/> 97422
	MARS	54" x 30" x 3/4"	FLB	<input type="checkbox"/> 86831	SLT	<input type="checkbox"/> 88686	SQ	<input type="checkbox"/> 86503
	MARS High-NRC	54" x 30" x 7/8"	FLB	<input type="checkbox"/> 86501	SLT	<input type="checkbox"/> 86464	SQ	<input type="checkbox"/> 86427

Channel Panels	HALCYON	6" x 60" x 1"	FL	<input type="checkbox"/> 98199	SL	<input type="checkbox"/> 99272	SQ	<input type="checkbox"/> 97228
	MARS	6" x 60" x 3/4"	FLB	<input type="checkbox"/> 86835	SLT	<input type="checkbox"/> 86543	SQ	<input type="checkbox"/> 86507
	MARS High-NRC	6" x 60" x 7/8"	FLB	<input type="checkbox"/> 86333	SLT	<input type="checkbox"/> 86443	SQ	<input type="checkbox"/> 86145
	PANZ Metal Panels, Solid	6" x 60"	FL	<input type="checkbox"/> 258036	SL	<input type="checkbox"/> 257972	SQ	<input type="checkbox"/> 257586
	Panz Metal Panels, Perf C116	6" x 60"	FL	<input type="checkbox"/> 259228	SL	<input type="checkbox"/> 259010	SQ	<input type="checkbox"/> 259009
	Panz Metal Panels, Perf C116D	6" x 60"	FL	<input type="checkbox"/> 259353	SL	<input type="checkbox"/> 259344	SQ	<input type="checkbox"/> 259308

Step 3. Select Corresponding Grid for Selected Panels

			Qty	Item No.	Qty	Item No.	Qty	Item No.
Suspension Systems	CENTRICITEE DXT	Main Tee		<input type="checkbox"/> DXT24				
		Cross Tee 1	2	<input type="checkbox"/> DXT524				
		Cross Tee 2	1	<input type="checkbox"/> DXT5424				
	IDENTITEE DXI	Main Tee		<input type="checkbox"/> DXI24				
		Cross Tee 1	2	<input type="checkbox"/> DXI524				
		Cross Tee 2	1	<input type="checkbox"/> DXI5424				
	DONN DX	Main Tee			<input type="checkbox"/> DX/DXL24		<input type="checkbox"/> DX/DXL24	
		Cross Tee 1			2	<input type="checkbox"/> DX524	2	<input type="checkbox"/> DX524
		Cross Tee 2			1	<input type="checkbox"/> DX5416	1	<input type="checkbox"/> DX5416

Suspension System Estimator

	Length	Sq. Ft.	Main Tee Usage Per Sq. Ft.	Cross Tee 1 Usage Per Sq. Ft.	Cross Tee 2 Usage Per Sq. Ft.	
System Module	60"	25	0.20	0.40	0.18	

Note: Multiply the ceiling area (SF) by the Usage Factor (UF). This calculation will determine lineal footage of suspension system components required. Please refer to the front of this catalogue or IC592 for stabilizer bar usage.

On-Module Channel Spacing

4' Ceiling Module



6" Channel

System 275

45" x 48" Infill Panel

48" x 48" Infill Panel

Selector

Channel Width	Ceiling Module	On-Center Channel Spacing	Infill Panels	Panel Edge	Suspension System
6"	4' (48")	12' (144")	HALCYON 45" x 48" x 1" 48" x 48" x 1"	FL 	DXT, DXI
				SL 	DX
				SQ 	DX

Module Layout

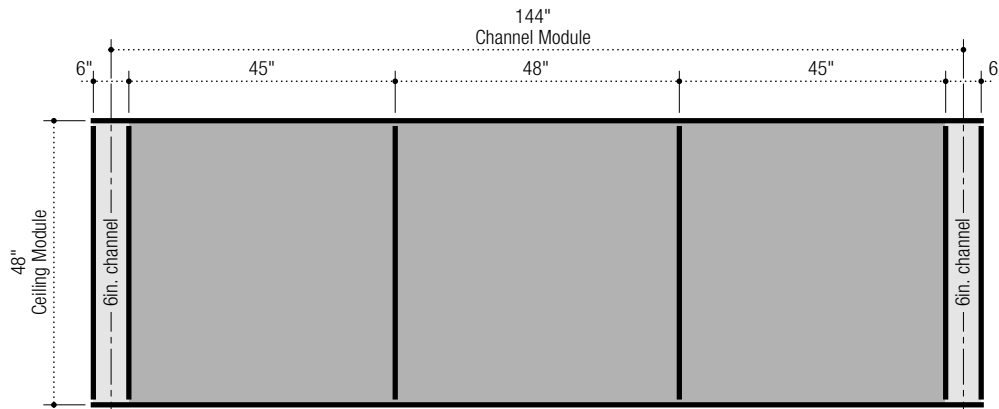

Panel Layout

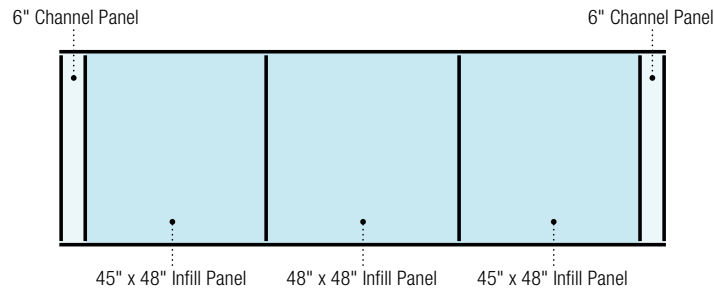

Suspension System Layout

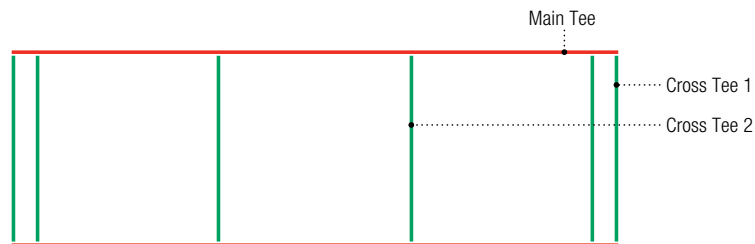

Order Information
System 275

4' Ceiling Module

6" Channel
45" x 48" Infill Panel
48" x 48" Infill Panel



Step 1. Select Panels

Step 2. Select Edge for Panels

			FL/FLB		SL/SLT		SQ	
			Edge	Item No.	Edge	Item No.	Edge	Item No.
Infill Panels	HALCYON	45" x 48" x 1"	FL	<input type="checkbox"/> 97476	SL	<input type="checkbox"/> 97456	SQ	<input type="checkbox"/> 97426
Channel Panels	HALCYON	6" x 48" x 1"	FL	<input type="checkbox"/> 98198	SL	<input type="checkbox"/> 99271	SQ	<input type="checkbox"/> 97227
	PANZ Metal Panels, Solid	6" x 48"	FL	<input type="checkbox"/> 256820	SL	<input type="checkbox"/> 256819	SQ	<input type="checkbox"/> 256768
	Panz Metal Panels, Perf C116	6" x 48"	FL	<input type="checkbox"/> 256062	SL	<input type="checkbox"/> 257248	SQ	<input type="checkbox"/> 256397
	Panz Metal Panels, Perf C116D	6" x 48"	FL	<input type="checkbox"/> 257585	SL	<input type="checkbox"/> 257584	SQ	<input type="checkbox"/> 257406

Step 3. Select Corresponding Grid for Selected Panels

			Qty	Item No.	Qty	Item No.	Qty	Item No.
Suspension Systems	CENTRICITEE DXT	Main Tee		<input type="checkbox"/> DXT24SP106				
		Cross Tee 1	2	<input type="checkbox"/> DXT424				
		Cross Tee 2	2	<input type="checkbox"/> DXT424				
	IDENTITEE DXI	Main Tee		<input type="checkbox"/> DXI24SP106				
		Cross Tee 1	2	<input type="checkbox"/> DXI424				
		Cross Tee 2	2	<input type="checkbox"/> DXI424				
	DONN DX	Main Tee			<input type="checkbox"/> DX24SP106	1	<input type="checkbox"/> DX24SP106	
		Cross Tee 1			<input type="checkbox"/> DX422	2	<input type="checkbox"/> DX422	
		Cross Tee 2			<input type="checkbox"/> DX422	2	<input type="checkbox"/> DX422	

Suspension System Estimator

	Length	Sq. Ft.	Main Tee Usage Per Sq. Ft.	Cross Tee 1 Usage Per Sq. Ft.	Cross Tee 2 Usage Per Sq. Ft.
System Module	144"	48	0.25	0.17	0.17

Note: Multiply the ceiling area (SF) by the Usage Factor (UF). This calculation will determine lineal footage of suspension system components required. Please refer to the front of this catalogue or IC592 for stabilizer bar usage.

On-Module Channel Spacing











4' Ceiling Module

12" Channel

System 944

24" x 48" Infill Panel

Selector

Channel Width	Ceiling Module	On-Center Channel Spacing	Infill Panels	Panel Edge	Suspension System
12"	4' (48")	5' (60")	HALCYON 24" x 48" x 1"	FL 	DXT, DXI
				SL 	DX
				SQ 	DX
			MARS 24" x 48 x 3/4"	FLB 	DXT, DXI
				SLT 	DX
				SQ 	DX
			MARS High-NRC 24" x 48" x 7/8"	FLB 	DXT, DXI
				SLT 	DX
				SQ 	DX
			PANZ Metal Panels, Solid 24" x 48"	FL 	DXT, DXI

Module Layout

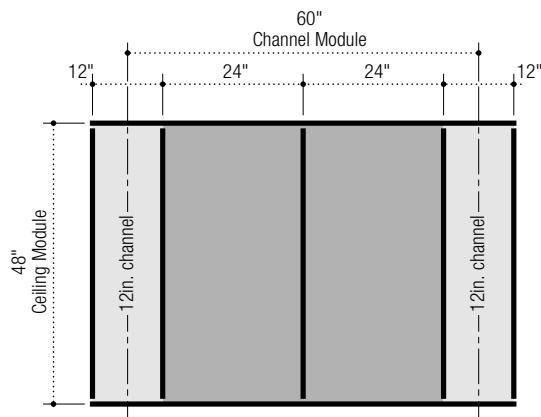

Panel Layout

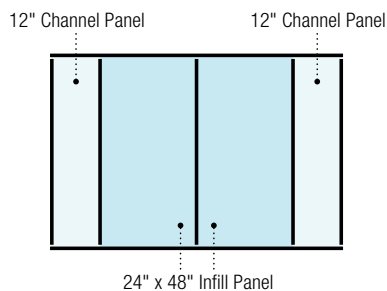

Suspension System Layout

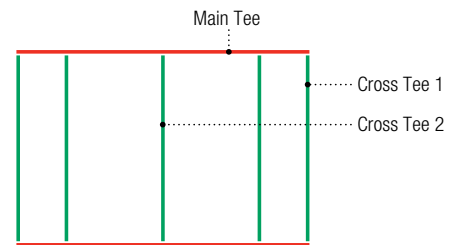

Order Information
System 944

4' Ceiling Module

12" Channel
24" x 48" Infill Panel



Step 1. Select Panels

Step 2. Select Edge for Panels

			FL/FLB		SL/SLT		SQ	
			Edge	Item No.	Edge	Item No.	Edge	Item No.
Infill Panels	HALCYON	24" x 48" x 1"	FL	<input type="checkbox"/> 98245	SL	<input type="checkbox"/> 98243	SQ	<input type="checkbox"/> 98241
	MARS	24" x 48" x 3/4"	FLB	<input type="checkbox"/> 88985	SLT	<input type="checkbox"/> 88785	SQ	<input type="checkbox"/> 88185
	MARS High-NRC	24" x 48" x 7/8"	FLB	<input type="checkbox"/> 89500	SLT	<input type="checkbox"/> 89600	SQ	<input type="checkbox"/> 86300
	PANZ Metal Panels, Solid	24" x 48"	FL	<input type="checkbox"/> 212164				

Channel Panels	HALCYON	12" x 48" x 1"	FL	<input type="checkbox"/> 97575	SL	<input type="checkbox"/> 97571	SQ	<input type="checkbox"/> 97491
	MARS	12" x 48" x 3/4"	FLB	<input type="checkbox"/> 86321	SLT	<input type="checkbox"/> 86544	SQ	<input type="checkbox"/> 86516
	MARS High-NRC	12" x 48" x 7/8"	FLB	<input type="checkbox"/> 86505	SLT	<input type="checkbox"/> 86444	SQ	<input type="checkbox"/> 86407
	PANZ Metal Panels, Solid	12" x 48"	FL	<input type="checkbox"/> 212144				

Step 3. Select Corresponding Grid for Selected Panels

			Qty	Item No.	Qty	Item No.	Qty	Item No.
Suspension Systems	CENTRICITEE DXT	Main Tee		<input type="checkbox"/> DXT24				
		Cross Tee 1	2	<input type="checkbox"/> DXT424				
		Cross Tee 2	1	<input type="checkbox"/> DXT424				
	IDENTITEE DXI	Main Tee		<input type="checkbox"/> DXI24				
		Cross Tee 1	2	<input type="checkbox"/> DXI424				
		Cross Tee 2	1	<input type="checkbox"/> DXI424				
	DONN DX	Main Tee				<input type="checkbox"/> DX/DXL24		<input type="checkbox"/> DX/DXL24
		Cross Tee 1			2	<input type="checkbox"/> DX422	2	<input type="checkbox"/> DX422
		Cross Tee 2			1	<input type="checkbox"/> DX422	1	<input type="checkbox"/> DX422

Suspension System Estimator

	Length	Sq. Ft.	Main Tee Usage Per Sq. Ft.	Cross Tee 1 Usage Per Sq. Ft.	Cross Tee 2 Usage Per Sq. Ft.	
System Module	60"	20	0.25	0.40	0.20	

Note: Multiply the ceiling area (SF) by the Usage Factor (UF). This calculation will determine lineal footage of suspension system components required. Please refer to the front of this catalogue or IC592 for stabilizer bar usage.

On-Module Channel Spacing











4' Ceiling Module

12" Channel

System 464

24" x 24" Infill Panel

Selector

Channel Width	Ceiling Module	On-Center Channel Spacing	Infill Panels	Panel Edge	Suspension System
12"	4' (48")	5' (60")	HALCYON 24" x 24" x 1"	FL 	DXT, DXI
				SL 	DX
				SQ 	DX, DXT
			MARS 24" x 24 x 3/4"	FLB 	DXT, DXI
				SLT 	DX
				SQ 	DX, DXT
			MARS High-NRC 24" x 24" x 7/8"	FLB 	DXT, DXI
				SLT 	DX
				SQ 	DX, DXT
			PANZ Metal Panels, Solid 24" x 24"	FL 	DXT, DXI

Module Layout

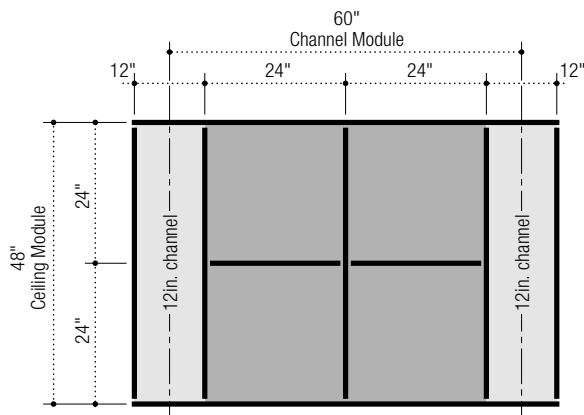

Panel Layout

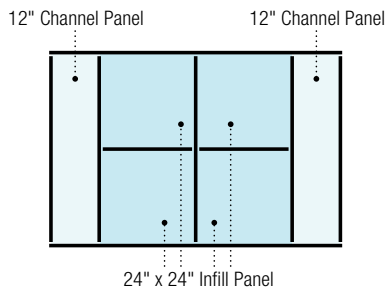

Suspension System Layout

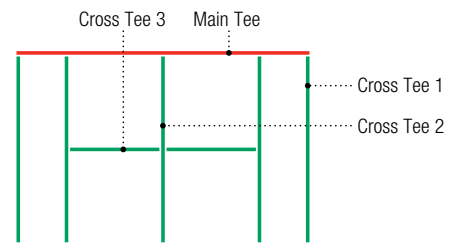

Order Information
System 464

4' Ceiling Module

12" Channel
24" x 24" Infill Panel

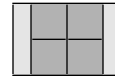

Step 1. Select Panels

Step 2. Select Edge for Panels

			FL/FLB		SL/SLT		SQ	
			Edge	Item No.	Edge	Item No.	Edge	Item No.
Infill Panels	HALCYON	24" x 24" x 1"	FL	<input type="checkbox"/> 98225	SL	<input type="checkbox"/> 98223	SQ	<input type="checkbox"/> 98221
	MARS	24" x 24" x 3/4"	FLB	<input type="checkbox"/> 86985	SLT	<input type="checkbox"/> 86785	SQ	<input type="checkbox"/> 86185
	MARS High-NRC	24" x 24" x 7/8"	FLB	<input type="checkbox"/> 87100	SLT	<input type="checkbox"/> 87200	SQ	<input type="checkbox"/> 86100
	PANZ Metal Panels, Solid	24" x 24"	FL	<input type="checkbox"/> 275616				

Channel Panels	HALCYON	12" x 48" x 1"	FL	<input type="checkbox"/> 97575	SL	<input type="checkbox"/> 97571	SQ	<input type="checkbox"/> 97491
	MARS	12" x 48" x 3/4"	FLB	<input type="checkbox"/> 86321	SLT	<input type="checkbox"/> 86544	SQ	<input type="checkbox"/> 86516
	MARS High-NRC	12" x 48" x 7/8"	FLB	<input type="checkbox"/> 86505	SLT	<input type="checkbox"/> 86444	SQ	<input type="checkbox"/> 86407
	PANZ Metal Panels, Solid	12" x 48"	FL	<input type="checkbox"/> 212144				

Step 3. Select Corresponding Grid for Selected Panels

			Qty	Item No.	Qty	Item No.	Qty	Item No.
Suspension Systems	CENTRICITEE DXT	Main Tee		<input type="checkbox"/> DXT24				<input type="checkbox"/> DXT24
		Cross Tee 1	2	<input type="checkbox"/> DXT424			2	<input type="checkbox"/> DXT424
		Cross Tee 2	1	<input type="checkbox"/> DXT424			1	<input type="checkbox"/> DXT424
		Cross Tee 3	2	<input type="checkbox"/> DXT222			2	<input type="checkbox"/> DXT222
	IDENTITEE DXI	Main Tee		<input type="checkbox"/> DXI24				
		Cross Tee 1	2	<input type="checkbox"/> DXI424				
		Cross Tee 2	1	<input type="checkbox"/> DXI424				
		Cross Tee 3	2	<input type="checkbox"/> DXI222				
	DONN DX	Main Tee				<input type="checkbox"/> DX/DXL24		<input type="checkbox"/> DX/DXL24
		Cross Tee 1			2	<input type="checkbox"/> DX422	2	<input type="checkbox"/> DX422
		Cross Tee 2			1	<input type="checkbox"/> DX422	1	<input type="checkbox"/> DX422
		Cross Tee 3			2	<input type="checkbox"/> DX216	2	<input type="checkbox"/> DX216

Suspension System Estimator

	Length	Sq. Ft.	Main Tee Usage Per Sq. Ft.	Cross Tee 1 Usage Per Sq. Ft.	Cross Tee 2 Usage Per Sq. Ft.	Cross Tee 3 Usage Per Sq. Ft.
System Module	60"	20	0.25	0.40	0.20	0.20

Note: Multiply the ceiling area (SF) by the Usage Factor (UF). This calculation will determine lineal footage of suspension system components required. Please refer to the front of this catalogue or IC592 for stabilizer bar usage.

On-Module Channel Spacing



4' Ceiling Module

12" Channel

System 279

48" x 48" Infill Panel

Selector

Channel Width	Ceiling Module	On-Center Channel Spacing	Infill Panels	Panel Edge	Suspension System
12"	4' (48")	5' (60")	HALCYON 48" x 48" x 1"	FL  SL  SQ 	DXT, DXI DX DX

Module Layout

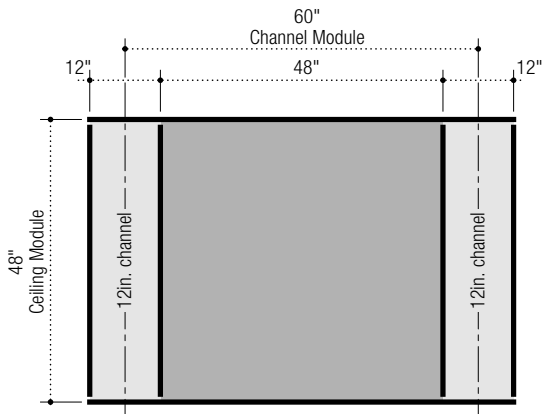

Panel Layout

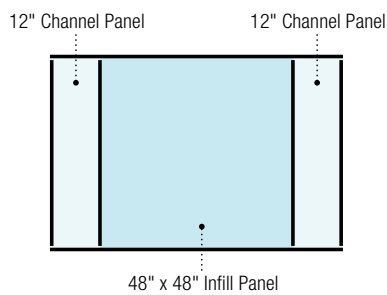

Suspension System Layout

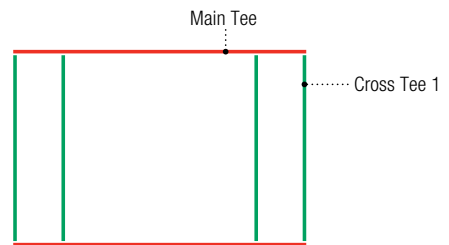

Order Information
System 279

4' Ceiling Module

12" Channel
48" x 48" Infill Panel



Step 1. Select Panels

Step 2. Select Edge for Panels

			FL/FLB		SL/SLT		SQ	
			Edge	Item No.	Edge	Item No.	Edge	Item No.
Infill Panels	HALCYON	48" x 48" x 1"	FL	<input type="checkbox"/> 98445	SL	<input type="checkbox"/> 98443	SQ	<input type="checkbox"/> 98441

Channel Panels	HALCYON	12" x 48" x 1"	FL	<input type="checkbox"/> 97575	SL	<input type="checkbox"/> 97571	SQ	<input type="checkbox"/> 97491
	PANZ Metal Panels, Solid	12" x 48"	FL	<input type="checkbox"/> 212144				

Step 3. Select Corresponding Grid for Selected Panels

			Qty	Item No.	Qty	Item No.	Qty	Item No.
Suspension Systems	CENTRICITEE DXT	Main Tee		<input type="checkbox"/> DXT24				
		Cross Tee 1	2	<input type="checkbox"/> DXT424				
	IDENTITEE DXI	Main Tee		<input type="checkbox"/> DXI24				
		Cross Tee 1	2	<input type="checkbox"/> DXI424				
	DONN DX	Main Tee			<input type="checkbox"/> DX/DXL24		<input type="checkbox"/> DX/DXL24	
		Cross Tee 1			2	<input type="checkbox"/> DX422	2	<input type="checkbox"/> DX422

Suspension System Estimator

	Length	Sq. Ft.	Main Tee Usage Per Sq. Ft.	Cross Tee 1 Usage Per Sq. Ft.	
System Module	60"	20	0.25	0.40	

Note: Multiply the ceiling area (SF) by the Usage Factor (UF). This calculation will determine lineal footage of suspension system components required. Please refer to the front of this catalogue or IC592 for stabilizer bar usage.

On-Module Channel Spacing











5' Ceiling Module

12" Channel

System 372

30" x 60" Infill Panel

Selector

Channel Width	Ceiling Module	On-Center Channel Spacing	Infill Panels	Panel Edge	Suspension System
12"	5' (60")	6' (72")	HALCYON 30" x 60" x 1"	FL 	DXT, DXI
				SL 	DX
				SQ 	DX
			MARS 30" x 60" x 3/4"	FLB 	DXT, DXI
				SLT 	DX
				SQ 	DX
			MARS High-NRC 30" x 60" x 7/8"	FLB 	DXT, DXI
				SLT 	DX
				SQ 	DX
			PANZ Metal Panels, Solid 30" x 60"	FL 	DXT, DXI

Module Layout

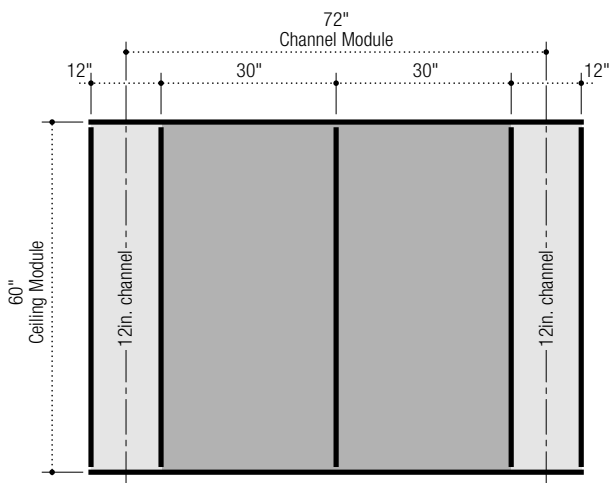

Panel Layout

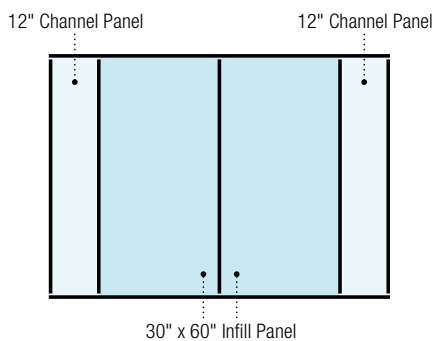

Suspension System Layout

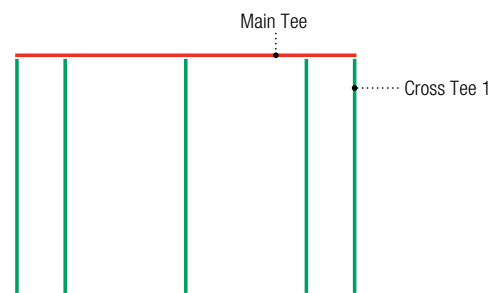

Order Information
System 372

5' Ceiling Module

12" Channel
30" x 60" Infill Panel

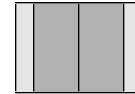

Step 1. Select Panels

Step 2. Select Edge for Panels

			FL/FLB		SL/SLT		SQ	
			Edge	Item No.	Edge	Item No.	Edge	Item No.
Infill Panels	HALCYON	30" x 60" x 1"	FL	<input type="checkbox"/> 98336	SL	<input type="checkbox"/> 99270	SQ	<input type="checkbox"/> 97266
	MARS	30" x 60" x 3/4"	FLB	<input type="checkbox"/> 86267	SLT	<input type="checkbox"/> 86564	SQ	<input type="checkbox"/> 86536
	MARS High-NRC	30" x 60" x 7/8"	FLB	<input type="checkbox"/> 86497	SLT	<input type="checkbox"/> 86466	SQ	<input type="checkbox"/> 86429
	PANZ Metal Panels, Solid	30" x 60"	FL	<input type="checkbox"/> 212201				

Channel Panels	HALCYON	12" x 60" x 1"	FL	<input type="checkbox"/> 97576	SL	<input type="checkbox"/> 97434	SQ	<input type="checkbox"/> 97492
	MARS	12" x 60" x 3/4"	FLB	<input type="checkbox"/> 88885	SLT	<input type="checkbox"/> 86545	SQ	<input type="checkbox"/> 86517
	MARS High-NRC	12" x 60" x 7/8"	FLB	<input type="checkbox"/> 86477	SLT	<input type="checkbox"/> 86445	SQ	<input type="checkbox"/> 86408
	PANZ Metal Panels, Solid	12" x 60"	FL	<input type="checkbox"/> 212160				

Step 3. Select Corresponding Grid for Selected Panels

			Qty	Item No.	Qty	Item No.	Qty	Item No.
Suspension Systems	CENTRICITEE DXT	Main Tee		<input type="checkbox"/> DXT24				
		Cross Tee 1	2	<input type="checkbox"/> DXT524				
	IDENTITEE DXI	Main Tee		<input type="checkbox"/> DXI24				
		Cross Tee 1	2	<input type="checkbox"/> DXI524				
	DONN DX	Main Tee			<input type="checkbox"/> DX/DXL24		<input type="checkbox"/> DX/DXL24	
		Cross Tee 1			2	<input type="checkbox"/> DX524	2	<input type="checkbox"/> DX524

Suspension System Estimator

	Length	Sq. Ft.	Main Tee Usage Per Sq. Ft.	Cross Tee 1 Usage Per Sq. Ft.	Cross Tee 2 Usage Per Sq. Ft.	
System Module	72"	30	0.20	0.33	0.17	

Note: Multiply the ceiling area (SF) by the Usage Factor (UF). This calculation will determine lineal footage of suspension system components required. Please refer to the front of this catalogue or IC592 for stabilizer bar usage.

On-Module Channel Spacing











5' Ceiling Module

12" Channel

System 934

30" x 30" Infill Panel

Selector

Channel Width	Ceiling Module	On-Center Channel Spacing	Infill Panels	Panel Edge	Suspension System
12"	5' (60")	6' (72")	HALCYON 30" x 30" x 1"	FL 	DXT, DXI
				SL 	DX
				SQ 	DX
			MARS 30" x 30" x 3/4"	FLB 	DXT, DXI
				SLT 	DX
				SQ 	DX
			MARS High-NRC 30" x 30" x 7/8"	FLB 	DXT, DXI
				SLT 	DX
				SQ 	DX
			PANZ Metal Panels, Solid 30" x 30"	FL 	DXT, DXI

Module Layout

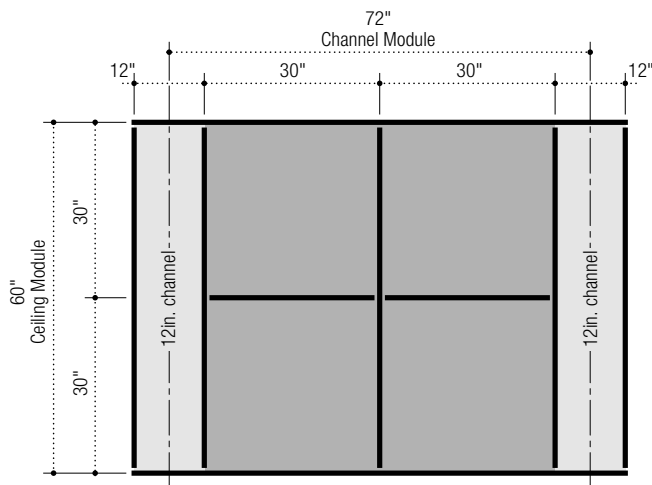

Panel Layout

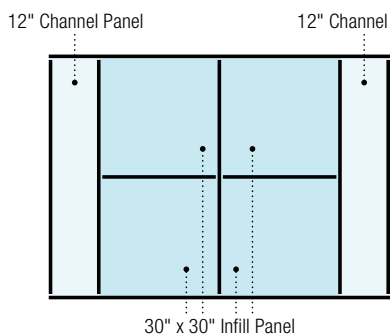

Suspension System Layout

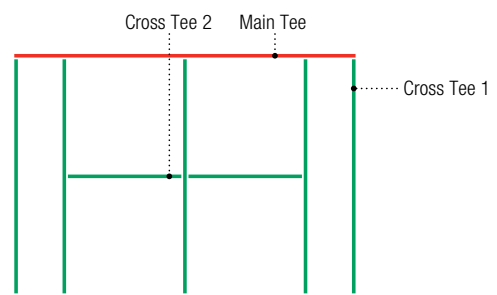

Order Information
System 934

5' Ceiling Module

12" Channel
30" x 30" Infill Panel

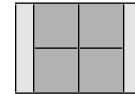

Step 1. Select Panels

Step 2. Select Edge for Panels

			FL/FLB		SL/SLT		SQ	
			Edge	Item No.	Edge	Item No.	Edge	Item No.
Infill Panels	HALCYON	30" x 30" x 1"	FL	<input type="checkbox"/> 98335	SL	<input type="checkbox"/> 98333	SQ	<input type="checkbox"/> 98331
	MARS	30" x 30" x 3/4"	FLB	<input type="checkbox"/> 86830	SLT	<input type="checkbox"/> 86875	SQ	<input type="checkbox"/> 86815
	MARS High-NRC	30" x 30" x 7/8"	FLB	<input type="checkbox"/> 86400	SLT	<input type="checkbox"/> 86500	SQ	<input type="checkbox"/> 86426
	PANZ Metal Panels, Solid	30" x 30"	FL	<input type="checkbox"/> 212123				

Channel Panels	HALCYON	12" x 60" x 1"	FL	<input type="checkbox"/> 97576	SL	<input type="checkbox"/> 97434	SQ	<input type="checkbox"/> 97492
	MARS	12" x 60" x 3/4"	FLB	<input type="checkbox"/> 88885	SLT	<input type="checkbox"/> 86545	SQ	<input type="checkbox"/> 86517
	MARS High-NRC	12" x 60" x 7/8"	FLB	<input type="checkbox"/> 86477	SLT	<input type="checkbox"/> 86445	SQ	<input type="checkbox"/> 86408
	PANZ Metal Panels, Solid	12" x 60"	FL	<input type="checkbox"/> 212160				

Step 3. Select Corresponding Grid for Selected Panels

			Qty	Item No.	Qty	Item No.	Qty	Item No.
Suspension Systems	CENTRICITEE DXT	Main Tee		<input type="checkbox"/> DXT24				
		Cross Tee 1	2	<input type="checkbox"/> DXT524				
		Cross Tee 2	2	<input type="checkbox"/> DXT3022				
	IDENTITEE DXI	Main Tee		<input type="checkbox"/> DXI24				
		Cross Tee 1	2	<input type="checkbox"/> DXI524				
		Cross Tee 2	2	<input type="checkbox"/> DXI3022				
	DONN DX	Main Tee				<input type="checkbox"/> DX/DXL24		<input type="checkbox"/> DX/DXL24
		Cross Tee 1			2	<input type="checkbox"/> DX524	2	<input type="checkbox"/> DX524
		Cross Tee 2			2	<input type="checkbox"/> DX3016	2	<input type="checkbox"/> DX3016

Suspension System Estimator

	Length	Sq. Ft.	Main Tee Usage Per Sq. Ft.	Cross Tee 1 Usage Per Sq. Ft.	Cross Tee 2 Usage Per Sq. Ft.	Cross Tee 3 Usage Per Sq. Ft.
System Module	729	30	0.20	0.33	0.17	0.17

Note: Multiply the ceiling area (SF) by the Usage Factor (UF). This calculation will determine lineal footage of suspension system components required. Please refer to the front of this catalogue or IC592 for stabilizer bar usage.

On-Module Channel Spacing











5' Ceiling Module

12" Channel

System 649

60" x 20" Infill Panel

Selector

Channel Width	Ceiling Module	On-Center Channel Spacing	Infill Panels	Panel Edge	Suspension System			
12"	5' (60")	6' (72")	HALCYON	60" x 20" x 1"	FL 	DXT, DXI		
					SL 	DX		
					SQ 	DX		
			MARS	60" x 20" x 3/4"	FLB 	DXT, DXI		
					SLT 	DX		
					SQ 	DX		
			MARS High-NRC	60" x 20" x 7/8"	FLB 	DXT, DXI		
					SLT 	DX		
					SQ 	DX		
			PANZ Metal Panels, Solid			60" x 20"	FL 	DXT, DXI

Module Layout

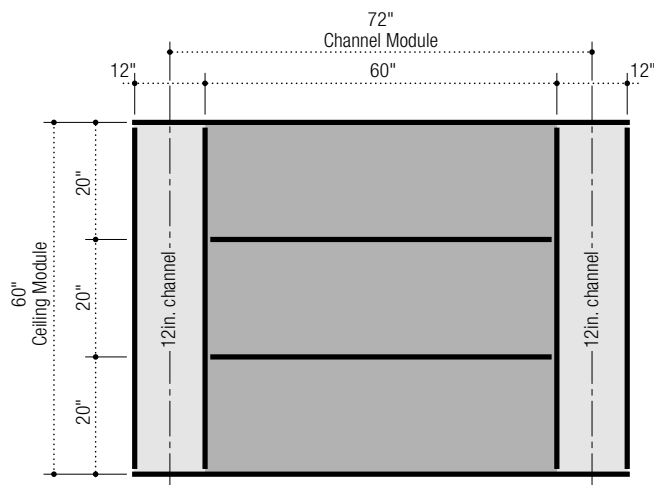

Panel Layout

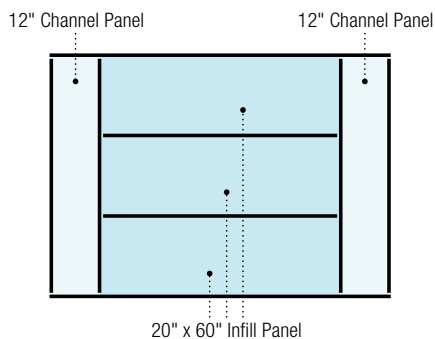

Suspension System Layout

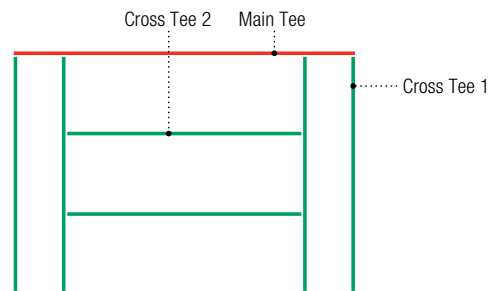

Order Information
System 649

5' Ceiling Module

12" Channel
60" x 20" Infill Panel

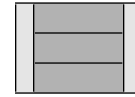

Step 1. Select Panels

Step 2. Select Edge for Panels

			FL/FLB		SL/SLT		SQ	
			Edge	Item No.	Edge	Item No.	Edge	Item No.
Infill Panels	HALCYON	60" x 20" x 1"	FL	<input type="checkbox"/> 98194	SL	<input type="checkbox"/> 99267	SQ	<input type="checkbox"/> 98261
	MARS	60" x 20" x 3/4"	FLB	<input type="checkbox"/> 86164	SLT	<input type="checkbox"/> 86905	SQ	<input type="checkbox"/> 86160
	MARS High-NRC	60" x 20" x 7/8"	FLB	<input type="checkbox"/> 86481	SLT	<input type="checkbox"/> 86449	SQ	<input type="checkbox"/> 89501
	PANZ Metal Panels, Solid	60" x 20"	FL	<input type="checkbox"/> 212181				

Channel Panels	HALCYON	12" x 60" x 1"	FL	<input type="checkbox"/> 97576	SL	<input type="checkbox"/> 97434	SQ	<input type="checkbox"/> 97492
	MARS	12" x 60" x 3/4"	FLB	<input type="checkbox"/> 88885	SLT	<input type="checkbox"/> 86545	SQ	<input type="checkbox"/> 86517
	MARS High-NRC	12" x 60" x 7/8"	FLB	<input type="checkbox"/> 86477	SLT	<input type="checkbox"/> 86445	SQ	<input type="checkbox"/> 86408
	PANZ Metal Panels, Solid	12" x 60"	FL	<input type="checkbox"/> 212160				

Step 3. Select Corresponding Grid for Selected Panels

			Qty	Item No.	Qty	Item No.	Qty	Item No.
Suspension Systems	CENTRICITEE DXT	Main Tee		<input type="checkbox"/> DXT24				
		Cross Tee 1	2	<input type="checkbox"/> DXT524				
		Cross Tee 2	2	<input type="checkbox"/> DXT524				
	IDENTITEE DXI	Main Tee		<input type="checkbox"/> DXI24				
		Cross Tee 1	2	<input type="checkbox"/> DXI524				
		Cross Tee 2	2	<input type="checkbox"/> DXI524				
	DONN DX	Main Tee				<input type="checkbox"/> DX/DXL24		<input type="checkbox"/> DX/DXL24
		Cross Tee 1			2	<input type="checkbox"/> DX524	2	<input type="checkbox"/> DX524
		Cross Tee 2			2	<input type="checkbox"/> DX524	2	<input type="checkbox"/> DX524

Suspension System Estimator

	Length	Sq. Ft.	Main Tee Usage Per Sq. Ft.	Cross Tee 1 Usage Per Sq. Ft.	Cross Tee 2 Usage Per Sq. Ft.	
System Module	72"	30	0.20	0.33	0.33	

Note: Multiply the ceiling area (SF) by the Usage Factor (UF). This calculation will determine lineal footage of suspension system components required. Please refer to the front of this catalogue or IC592 for stabilizer bar usage.

On-Module Channel Spacing











6' Ceiling Module

12" Channel

System 997

24" x 48" Infill Panel

Selector

Channel Width	Ceiling Module	On-Center Channel Spacing	Infill Panels	Panel Edge	Suspension System
12"	6' (72")	5' (60")	HALCYON 24" x 48" x 1"	FL 	DXT, DXI
				SL 	DX
				SQ 	DX
			MARS 24" x 48 x 3/4"	FLB 	DXT, DXI
				SLT 	DX
				SQ 	DX
			MARS High-NRC 24" x 48" x 7/8"	FLB 	DXT, DXI
				SLT 	DX
				SQ 	DX
			PANZ Metal Panels, Solid 24" x 48"	FL 	DXT, DXI

Module Layout

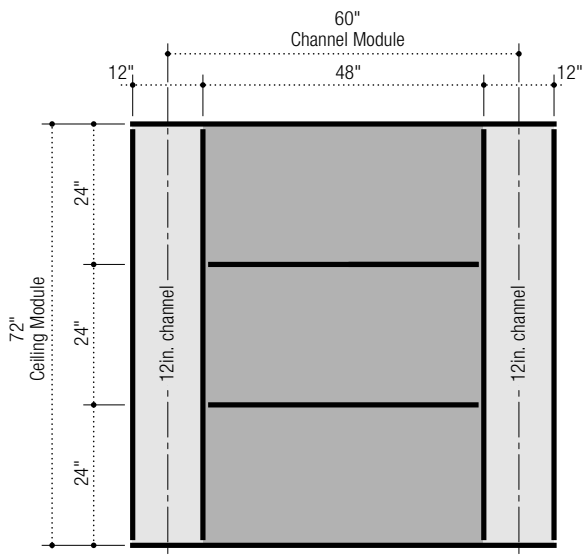

Panel Layout

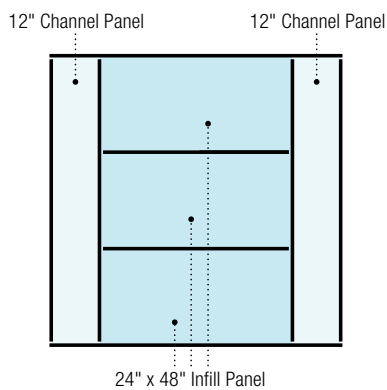

Suspension System Layout

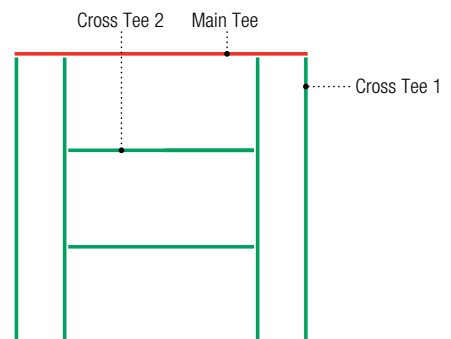

Order Information
System 997

6' Ceiling Module

12" Channel
24" x 48" Infill Panel

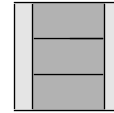

Step 1. Select Panels

Step 2. Select Edge for Panels

			FL/FLB		SL/SLT		SQ	
			Edge	Item No.	Edge	Item No.	Edge	Item No.
Infill Panels	HALCYON	24" x 48" x 1"	FL	<input type="checkbox"/> 98245	SL	<input type="checkbox"/> 98243	SQ	<input type="checkbox"/> 98241
	MARS	24" x 48" x 3/4"	FLB	<input type="checkbox"/> 88985	SLT	<input type="checkbox"/> 88785	SQ	<input type="checkbox"/> 88185
	MARS High-NRC	24" x 48" x 7/8"	FLB	<input type="checkbox"/> 89500	SLT	<input type="checkbox"/> 89600	SQ	<input type="checkbox"/> 86300
	PANZ Metal Panels, Solid	24" x 48"	FL	<input type="checkbox"/> 212164				

Channel Panels	HALCYON	12" x 72" x 1"	FL	<input type="checkbox"/> 97463	SL	<input type="checkbox"/> 97435	SQ	<input type="checkbox"/> 97406
	MARS	12" x 72" x 3/4"	FLB	<input type="checkbox"/> 86570	SLT	<input type="checkbox"/> 86546	SQ	<input type="checkbox"/> 86518
	MARS High-NRC	12" x 72" x 7/8"	FLB	<input type="checkbox"/> 86478	SLT	<input type="checkbox"/> 86446	SQ	<input type="checkbox"/> 86409
	PANZ Metal Panels, Solid	12" x 72"	FL	<input type="checkbox"/> 202654				

Step 3. Select Corresponding Grid for Selected Panels

			Qty	Item No.	Qty	Item No.	Qty	Item No.
Suspension Systems	CENTRICITEE DXT	Main Tee		<input type="checkbox"/> DXT24				
		Cross Tee 1	2	<input type="checkbox"/> DXT624				
		Cross Tee 2	2	<input type="checkbox"/> DXT424				
	IDENTITEE DXI	Main Tee		<input type="checkbox"/> DXI24				
		Cross Tee 1	2	<input type="checkbox"/> DXI624				
		Cross Tee 2	2	<input type="checkbox"/> DXI424				
	DONN DX	Main Tee				<input type="checkbox"/> DX/DXL24		<input type="checkbox"/> DX/DXL24
		Cross Tee 1			2	<input type="checkbox"/> DX624	2	<input type="checkbox"/> DX624
		Cross Tee 2			2	<input type="checkbox"/> DX422	2	<input type="checkbox"/> DX422

Suspension System Estimator

	Length	Sq. Ft.	Main Tee Usage Per Sq. Ft.	Cross Tee 1 Usage Per Sq. Ft.	Cross Tee 2 Usage Per Sq. Ft.	
System Module	60"	30	0.17	0.40	0.27	

Note: Multiply the ceiling area (SF) by the Usage Factor (UF). This calculation will determine lineal footage of suspension system components required. Please refer to the front of this catalogue or IC592 for stabilizer bar usage.

On-Module Channel Spacing











6' Ceiling Module

12" Channel

System 665

24" x 24" Infill Panel

Selector

Channel Width	Ceiling Module	On-Center Channel Spacing	Infill Panels	Panel Edge	Suspension System		
12"	6' (72")	5' (60")	HALCYON 24" x 24" x 1"	FL 	DXT, DXI		
				SL 	DX		
				SQ 	DX, DXT		
			MARS 24" x 24" x 3/4"	FLB 	DXT, DXI		
				SLT 	DX		
				SQ 	DX, DXT		
			MARS High-NRC 24" x 24" x 7/8"	FLB 	DXT, DXI		
				SLT 	DX		
				SQ 	DX, DXT		
			PANZ Metal Panels, Solid 24" x 24"			FL 	DXT, DXI

Module Layout

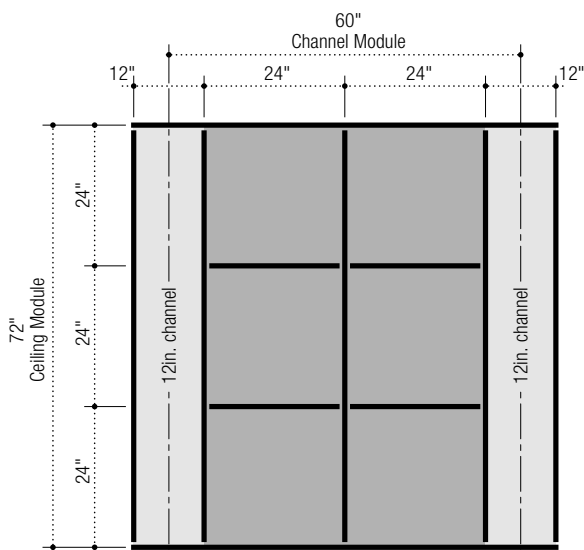

Panel Layout

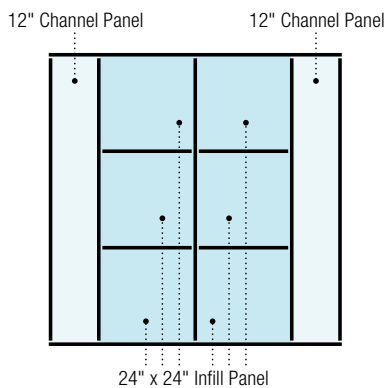

Suspension System Layout

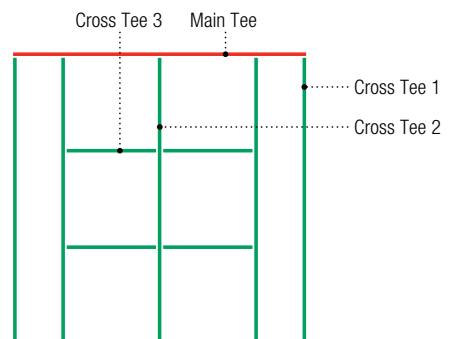

Order Information
System 665

6' Ceiling Module

12" Channel
24" x 24" Infill Panel

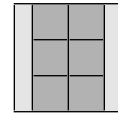

Step 1. Select Panels

Step 2. Select Edge for Panels

			FL/FLB		SL/SLT		SQ	
			Edge	Item No.	Edge	Item No.	Edge	Item No.
Infill Panels	HALCYON	24" x 24" x 1"	FL	<input type="checkbox"/> 98225	SL	<input type="checkbox"/> 98223	SQ	<input type="checkbox"/> 98221
	MARS	24" x 24" x 3/4"	FLB	<input type="checkbox"/> 86985	SLT	<input type="checkbox"/> 86785	SQ	<input type="checkbox"/> 86185
	MARS High-NRC	24" x 24" x 7/8"	FLB	<input type="checkbox"/> 87100	SLT	<input type="checkbox"/> 87200	SQ	<input type="checkbox"/> 86100
	PANZ Metal Panels, Solid	24" x 24"	FL	<input type="checkbox"/> 275616				

Channel Panels	HALCYON	12" x 72" x 1"	FL	<input type="checkbox"/> 97463	SL	<input type="checkbox"/> 97435	SQ	<input type="checkbox"/> 97406
	MARS	12" x 72" x 3/4"	FLB	<input type="checkbox"/> 86570	SLT	<input type="checkbox"/> 86546	SQ	<input type="checkbox"/> 86518
	MARS High-NRC	12" x 72" x 7/8"	FLB	<input type="checkbox"/> 86478	SLT	<input type="checkbox"/> 86446	SQ	<input type="checkbox"/> 86409
	PANZ Metal Panels, Solid	12" x 72"	FL	<input type="checkbox"/> 202654				

Step 3. Select Corresponding Grid for Selected Panels

			Qty	Item No.	Qty	Item No.	Qty	Item No.
Suspension Systems	CENTRICITEE DXT	Main Tee		<input type="checkbox"/> DXT24				<input type="checkbox"/> DXT24
		Cross Tee 1	2	<input type="checkbox"/> DXT624			2	<input type="checkbox"/> DXT624
		Cross Tee 2	1	<input type="checkbox"/> DXT624			1	<input type="checkbox"/> DXT624
		Cross Tee 3	4	<input type="checkbox"/> DXT222			4	<input type="checkbox"/> DXT222
	IDENTITEE DXI	Main Tee		<input type="checkbox"/> DXI24				
		Cross Tee 1	2	<input type="checkbox"/> DXI624				
		Cross Tee 2	1	<input type="checkbox"/> DXI624				
		Cross Tee 3	4	<input type="checkbox"/> DXI222				
	DONN DX	Main Tee				<input type="checkbox"/> DX/DXL24		<input type="checkbox"/> DX/DXL24
		Cross Tee 1			2	<input type="checkbox"/> DX624	2	<input type="checkbox"/> DX624
		Cross Tee 2			1	<input type="checkbox"/> DX624	1	<input type="checkbox"/> DX624
		Cross Tee 3			4	<input type="checkbox"/> DX216	4	<input type="checkbox"/> DX216

Suspension System Estimator

	Length	Sq. Ft.	Main Tee Usage Per Sq. Ft.	Cross Tee 1 Usage Per Sq. Ft.	Cross Tee 2 Usage Per Sq. Ft.	Cross Tee 3 Usage Per Sq. Ft.
System Module	60"	30	0.17	0.40	0.20	0.27

Note: Multiply the ceiling area (SF) by the Usage Factor (UF). This calculation will determine lineal footage of suspension system components required. Please refer to the front of this catalogue or IC592 for stabilizer bar usage.

On-Module Channel Spacing











6' Ceiling Module

12" Channel

System 785

24" x 72" Infill Panel

Selector

Channel Width	Ceiling Module	On-Center Channel Spacing	Infill Panels	Panel Edge	Suspension System	
12"	6' (72")	5' (60")	HALCYON	24" x 72" x 1"	FL 	DXT, DXI
					SL 	DX
					SQ 	DX
			MARS	24" x 72" x 3/4"	FLB 	DXT, DXI
					SLT 	DX
					SQ 	DX
			MARS High-NRC	24" x 72" x 7/8"	FLB 	DXT, DXI
					SLT 	DX
					SQ 	DX
			PANZ Metal Panels, Solid	24" x 72"	FL 	DXT, DXI

Module Layout

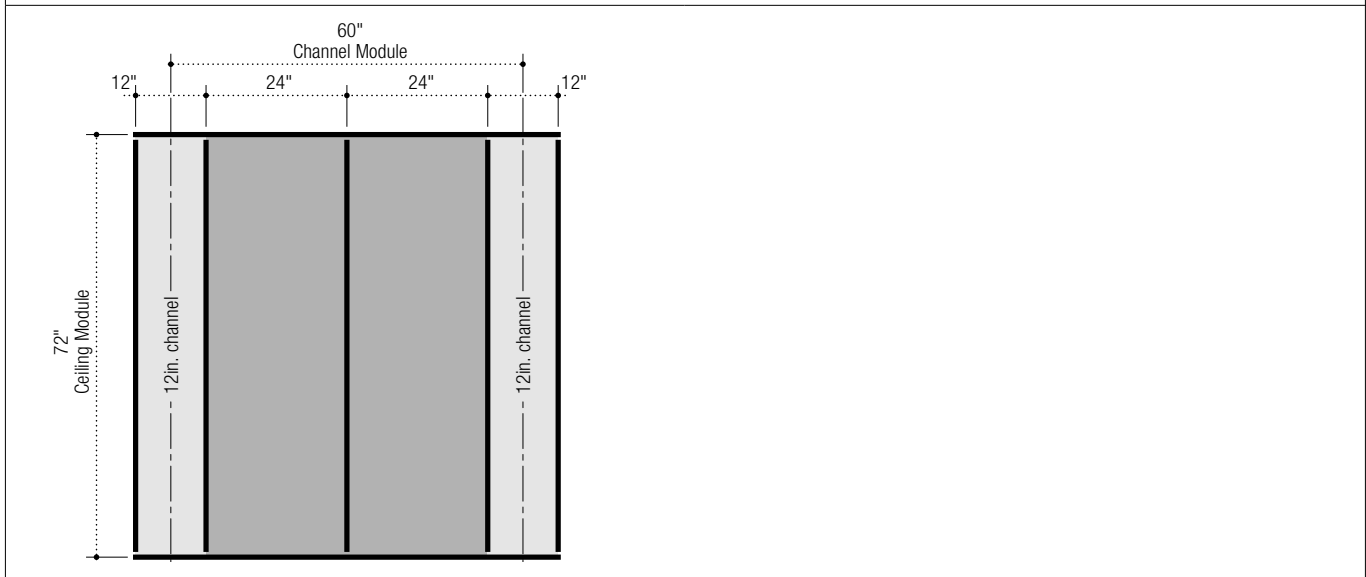

Panel Layout

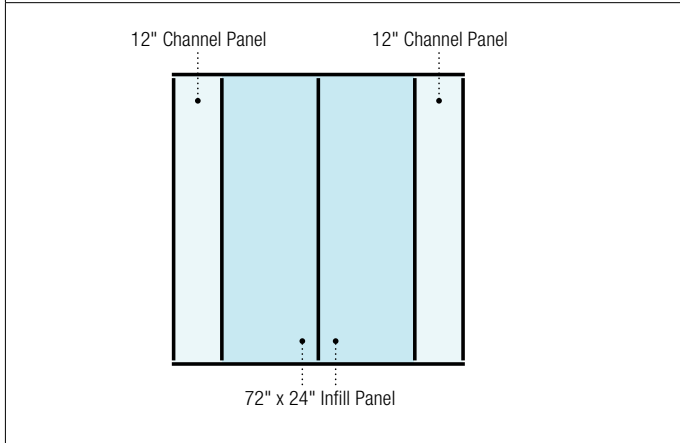

Suspension System Layout

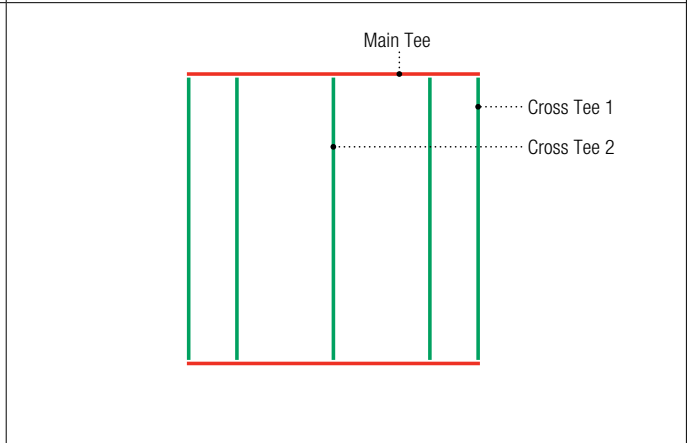

Order Information
System 785

6' Ceiling Module

12" Channel
24" x 72" Infill Panel

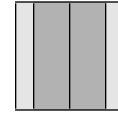

Step 1. Select Panels

Step 2. Select Edge for Panels

			FL/FLB		SL/SLT		SQ	
			Edge	Item No.	Edge	Item No.	Edge	Item No.
Infill Panels	HALCYON	24" x 72" x 1"	FL	<input type="checkbox"/> 98348	SL	<input type="checkbox"/> 99268	SQ	<input type="checkbox"/> 99234
	MARS	24" x 72" x 3/4"	FLB	<input type="checkbox"/> 88996	SLT	<input type="checkbox"/> 86166	SQ	<input type="checkbox"/> 86223
	MARS High-NRC	24" x 72" x 7/8"	FLB	<input type="checkbox"/> 89670	SLT	<input type="checkbox"/> 89660	SQ	<input type="checkbox"/> 86360
	PANZ Metal Panels, Solid	24" x 72"	FL	<input type="checkbox"/> 212192				

Channel Panels	HALCYON	12" x 72" x 1"	FL	<input type="checkbox"/> 97463	SL	<input type="checkbox"/> 97435	SQ	<input type="checkbox"/> 97406
	MARS	12" x 72" x 3/4"	FLB	<input type="checkbox"/> 86570	SLT	<input type="checkbox"/> 86546	SQ	<input type="checkbox"/> 86518
	MARS High-NRC	12" x 72" x 7/8"	FLB	<input type="checkbox"/> 86478	SLT	<input type="checkbox"/> 86446	SQ	<input type="checkbox"/> 86409
	PANZ Metal Panels, Solid	12" x 72"	FL	<input type="checkbox"/> 202654				

Step 3. Select Corresponding Grid for Selected Panels

			Qty	Item No.	Qty	Item No.	Qty	Item No.
Suspension Systems	CENTRICITEE DXT	Main Tee		<input type="checkbox"/> DXT24				
		Cross Tee 1	2	<input type="checkbox"/> DXT624				
		Cross Tee 2	1	<input type="checkbox"/> DXT624				
	IDENTITEE DXI	Main Tee		<input type="checkbox"/> DXI24				
		Cross Tee 1	2	<input type="checkbox"/> DXI624				
		Cross Tee 2	1	<input type="checkbox"/> DXI624				
	DONN DX	Main Tee				<input type="checkbox"/> DX/DXL24		<input type="checkbox"/> DX/DXL24
		Cross Tee 1			2	<input type="checkbox"/> DX624	2	<input type="checkbox"/> DX624
		Cross Tee 2			1	<input type="checkbox"/> DX624	1	<input type="checkbox"/> DX624

Suspension System Estimator

	Length	Sq. Ft.	Main Tee Usage Per Sq. Ft.	Cross Tee 1 Usage Per Sq. Ft.	Cross Tee 2 Usage Per Sq. Ft.	
System Module	60"	30	0.17	0.40	0.20	

Note: Multiply the ceiling area (SF) by the Usage Factor (UF). This calculation will determine lineal footage of suspension system components required. Please refer to the front of this catalogue or IC592 for stabilizer bar usage.

Off-Module Channel Spacing











4' Ceiling Module

4" Channel

System 367

24" x 48" Infill Panel

Selector

Channel Width	Ceiling Module	On-Center Channel Spacing	Infill Panels	Panel Edge	Suspension System
4"	4' (48")	4' - 4" (52")	HALCYON 24" x 48" x 1"	FL 	DXT, DXI
				SL 	DX
				SQ 	DX
			MARS 24" x 48" x 3/4"	FLB 	DXT, DXI
				SLT 	DX
				SQ 	DX
			MARS High-NRC 24" x 48" x 7/8"	FLB 	DXT, DXI
				SLT 	DX
				SQ 	DX
			PANZ Metal Panels, Solid 24" x 48"	FL 	DXT, DXI

Module Layout

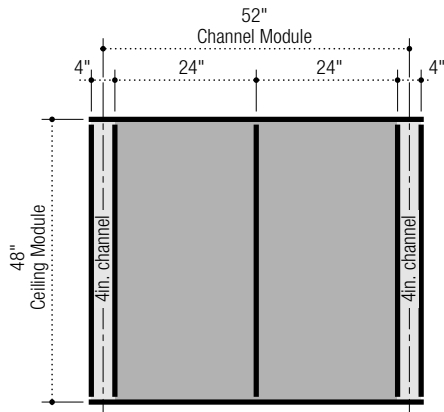

Panel Layout

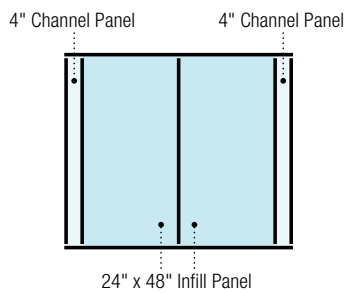

Suspension System Layout

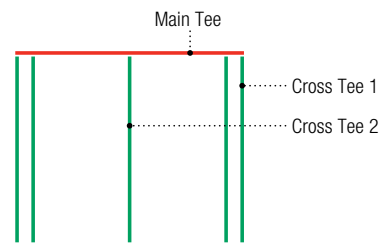

Order Information
System 367

4' Ceiling Module

4" Channel
24" x 48" Infill Panel



Step 1. Select Panels

Step 2. Select Edge for Panels

			FL/FLB		SL/SLT		SQ	
			Edge	Item No.	Edge	Item No.	Edge	Item No.
Infill Panels	HALCYON	24" x 48" x 1"	FL	<input type="checkbox"/> 98245	SL	<input type="checkbox"/> 98243	SQ	<input type="checkbox"/> 98241
	MARS	24" x 48" x 3/4"	FLB	<input type="checkbox"/> 88985	SLT	<input type="checkbox"/> 88785	SQ	<input type="checkbox"/> 88185
	MARS High-NRC	24" x 48" x 7/8"	FLB	<input type="checkbox"/> 89500	SLT	<input type="checkbox"/> 89600	SQ	<input type="checkbox"/> 86300
	PANZ Metal Panels, Solid	24" x 48"	FL	<input type="checkbox"/> 212164				

Channel Panels	HALCYON	4" x 48" x 1"	FL	<input type="checkbox"/> 97460	SL	<input type="checkbox"/> 97430	SQ	<input type="checkbox"/> 97402
	MARS	4" x 48" x 3/4"	FLB	<input type="checkbox"/> 86568	SLT	<input type="checkbox"/> 86540	SQ	<input type="checkbox"/> 86514
	MARS High-NRC	4" x 48" x 7/8"	FLB	<input type="checkbox"/> 86475	SLT	<input type="checkbox"/> 86440	SQ	<input type="checkbox"/> 86402
	PANZ Metal Panels, Solid	4" x 48"	FL	<input type="checkbox"/> 202636				

Step 3. Select Corresponding Grid for Selected Panels

			Qty	Item No.	Qty	Item No.	Qty	Item No.	
Suspension Systems	CENTRICITEE DXT	Main Tee		<input type="checkbox"/> DXT24SP103					
		Cross Tee 1	2	<input type="checkbox"/> DXT424					
		Cross Tee 2	1	<input type="checkbox"/> DXT424					
	IDENTITEE DXI	Main Tee		<input type="checkbox"/> DXI24SP103					
		Cross Tee 1	2	<input type="checkbox"/> DXI424					
		Cross Tee 2	1	<input type="checkbox"/> DXI424					
	DONN DX	Main Tee				<input type="checkbox"/> DX24SP103		<input type="checkbox"/> DX24SP103	
		Cross Tee 1				2	<input type="checkbox"/> DX422	2	<input type="checkbox"/> DX422
		Cross Tee 2				1	<input type="checkbox"/> DX422	1	<input type="checkbox"/> DX422

Suspension System Estimator

	Length	Sq. Ft.	Main Tee Usage Per Sq. Ft.	Cross Tee 1 Usage Per Sq. Ft.	Cross Tee 2 Usage Per Sq. Ft.	
System Module	52"	17.333	0.25	0.46	0.23	

Note: Multiply the ceiling area (SF) by the Usage Factor (UF). This calculation will determine lineal footage of suspension system components required. Please refer to the front of this catalogue or IC592 for stabilizer bar usage.

Off-Module Channel Spacing











4' Ceiling Module

6" Channel

System 598

24" x 48" Infill Panel

Selector

Channel Width	Ceiling Module	On-Center Channel Spacing	Infill Panels	Panel Edge	Suspension System
6"	4' (48")	4' - 6" (54")	HALCYON 24" x 48" x 1"	FL 	DXT, DXI
				SL 	DX
				SQ 	DX
			MARS 24" x 48 x 3/4"	FLB 	DXT, DXI
				SLT 	DX
				SQ 	DX
			MARS High-NRC 24" x 48" x 7/8"	FLB 	DXT, DXI
				SLT 	DX
				SQ 	DX
			PANZ Metal Panels, Solid 24" x 48"	FL 	DXT, DXI

Module Layout

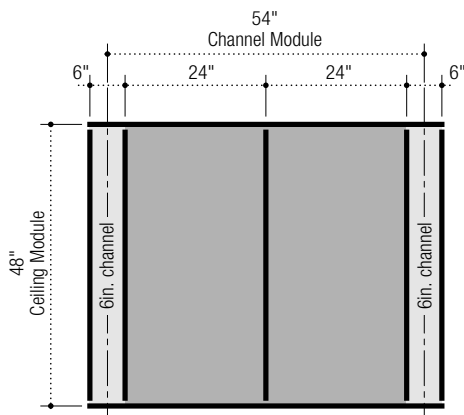

Panel Layout

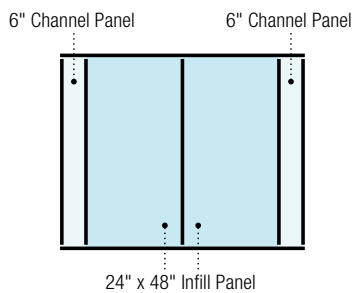

Suspension System Layout

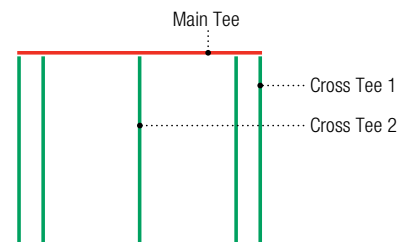

Order Information
System 598

4' Ceiling Module

6" Channel
24" x 48" Infill Panel



Step 1. Select Panels

Step 2. Select Edge for Panels

			FL/FLB		SL/SLT		SQ	
			Edge	Item No.	Edge	Item No.	Edge	Item No.
Infill Panels	HALCYON	24" x 48" x 1"	FL	<input type="checkbox"/> 98245	SL	<input type="checkbox"/> 98243	SQ	<input type="checkbox"/> 98241
	MARS	24" x 48" x 3/4"	FLB	<input type="checkbox"/> 88985	SLT	<input type="checkbox"/> 88785	SQ	<input type="checkbox"/> 88185
	MARS High-NRC	24" x 48" x 7/8"	FLB	<input type="checkbox"/> 89500	SLT	<input type="checkbox"/> 89600	SQ	<input type="checkbox"/> 86300
	PANZ Metal Panels, Solid	24" x 48"	FL	<input type="checkbox"/> 212164				

Channel Panels	HALCYON	6" x 48" x 1"	FL	<input type="checkbox"/> 98198	SL	<input type="checkbox"/> 99271	SQ	<input type="checkbox"/> 97227
	MARS	6" x 48" x 3/4"	FLB	<input type="checkbox"/> 88887	SLT	<input type="checkbox"/> 86542	SQ	<input type="checkbox"/> 86325
	MARS High-NRC	6" x 48" x 7/8"	FLB	<input type="checkbox"/> 86331	SLT	<input type="checkbox"/> 86442	SQ	<input type="checkbox"/> 86404
	PANZ Metal Panels, Solid	6" x 48"	FL	<input type="checkbox"/> 256820	SL	<input type="checkbox"/> 256819	SQ	<input type="checkbox"/> 256768
	Panz Metal Panels, Perf C116	6" x 48"	FL	<input type="checkbox"/> 256062	SL	<input type="checkbox"/> 257248	SQ	<input type="checkbox"/> 256397
	Panz Metal Panels, Perf C116D	6" x 48"	FL	<input type="checkbox"/> 257585	SL	<input type="checkbox"/> 257584	SQ	<input type="checkbox"/> 257406

Step 3. Select Corresponding Grid for Selected Panels

			Qty	Item No.	Qty	Item No.	Qty	Item No.
Suspension Systems	CENTRICITEE DXT	Main Tee		<input type="checkbox"/> DXT24				
		Cross Tee 1	2	<input type="checkbox"/> DXT424				
		Cross Tee 2	1	<input type="checkbox"/> DXT424				
	IDENTITEE DXI	Main Tee		<input type="checkbox"/> DXI24				
		Cross Tee 1	2	<input type="checkbox"/> DXI424				
		Cross Tee 2	1	<input type="checkbox"/> DXI424				
	DONN DX	Main Tee				<input type="checkbox"/> DX/DXL24		<input type="checkbox"/> DX/DXL24
		Cross Tee 1			2	<input type="checkbox"/> DX422	2	<input type="checkbox"/> DX422
		Cross Tee 2			1	<input type="checkbox"/> DX422	1	<input type="checkbox"/> DX422

Suspension System Estimator

	Length	Sq. Ft.	Main Tee Usage Per Sq. Ft.	Cross Tee 1 Usage Per Sq. Ft.	Cross Tee 2 Usage Per Sq. Ft.	
System Module	54"	18	0.25	.44	.22	

Note: Multiply the ceiling area (SF) by the Usage Factor (UF). This calculation will determine lineal footage of suspension system components required. Please refer to the front of this catalogue or IC592 for stabilizer bar usage.

Off-Module Channel Spacing











4' Ceiling Module

4" Channel

System 977

24" x 24" Infill Panel

Selector

Channel Width	Ceiling Module	On-Center Channel Spacing	Infill Panels	Panel Edge	Suspension System
4"	4' (48")	4' - 4" (52")	HALCYON 24" x 24" x 1"	FL 	DXT, DXI
				SL 	DX
				SQ 	DX, DXT
			MARS 24" x 24" x 3/4"	FLB 	DXT, DXI
				SLT 	DX
				SQ 	DX, DXT
			MARS High-NRC 24" x 24" x 7/8"	FLB 	DXT, DXI
				SLT 	DX
				SQ 	DX, DXT
			PANZ Metal Panels, Solid 24" x 24"	FL 	DXT, DXI

Module Layout

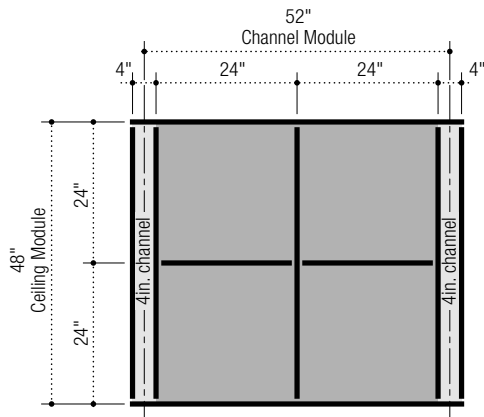

Panel Layout

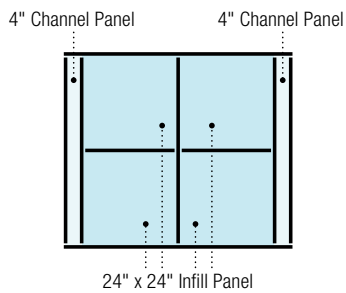

Suspension System Layout

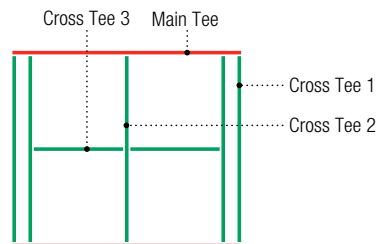

Order Information
System 977

4' Ceiling Module

4" Channel
24" x 24" Infill Panel



Step 1. Select Panels

Step 2. Select Edge for Panels

			FL/FLB		SL/SLT		SQ	
			Edge	Item No.	Edge	Item No.	Edge	Item No.
Infill Panels	HALCYON	24" x 24" x 1"	FL	<input type="checkbox"/> 98225	SL	<input type="checkbox"/> 98223	SQ	<input type="checkbox"/> 98221
	MARS	24" x 24" x 3/4"	FLB	<input type="checkbox"/> 86985	SLT	<input type="checkbox"/> 86785	SQ	<input type="checkbox"/> 86185
	MARS High-NRC	24" x 24" x 7/8"	FLB	<input type="checkbox"/> 87100	SLT	<input type="checkbox"/> 87200	SQ	<input type="checkbox"/> 86100
	PANZ Metal Panels, Solid	24" x 24"	FL	<input type="checkbox"/> 275616				

Channel Panels	HALCYON	4" x 48" x 1"	FL	<input type="checkbox"/> 97460	SL	<input type="checkbox"/> 97430	SQ	<input type="checkbox"/> 97402
	MARS	4" x 48" x 3/4"	FLB	<input type="checkbox"/> 86568	SLT	<input type="checkbox"/> 86540	SQ	<input type="checkbox"/> 86514
	MARS High-NRC	4" x 48" x 7/8"	FLB	<input type="checkbox"/> 86475	SLT	<input type="checkbox"/> 86440	SQ	<input type="checkbox"/> 86402

Step 3. Select Corresponding Grid for Selected Panels

			Qty	Item No.	Qty	Item No.	Qty	Item No.
Suspension Systems	CENTRICITEE DXT	Main Tee		<input type="checkbox"/> DXT24SP103			1	<input type="checkbox"/> DXT24SP103
		Cross Tee 1	2	<input type="checkbox"/> DXT424			2	<input type="checkbox"/> DXT424
		Cross Tee 2	1	<input type="checkbox"/> DXT424			1	<input type="checkbox"/> DXT424
		Cross Tee 3	2	<input type="checkbox"/> DXT222			2	<input type="checkbox"/> DXT222
	IDENTITEE DXI	Main Tee		<input type="checkbox"/> DXI24SP103				
		Cross Tee 1	2	<input type="checkbox"/> DXI424				
		Cross Tee 2	1	<input type="checkbox"/> DXI424				
		Cross Tee 3	2	<input type="checkbox"/> DXI222				
	DONN DX	Main Tee				<input type="checkbox"/> DX24SP103		<input type="checkbox"/> DX24SP103
		Cross Tee 1			2	<input type="checkbox"/> DX422	2	<input type="checkbox"/> DX422
		Cross Tee 2			1	<input type="checkbox"/> DX422	1	<input type="checkbox"/> DX422
		Cross Tee 3			2	<input type="checkbox"/> DX216	2	<input type="checkbox"/> DX216

Suspension System Estimator

	Length	Sq. Ft.	Main Tee Usage Per Sq. Ft.	Cross Tee 1 Usage Per Sq. Ft.	Cross Tee 2 Usage Per Sq. Ft.	Cross Tee 3 Usage Per Sq. Ft.
System Module	54"	18	0.25	0.44	0.22	0.22

Note: Multiply the ceiling area (SF) by the Usage Factor (UF). This calculation will determine lineal footage of suspension system components required. Please refer to the front of this catalogue or IC592 for stabilizer bar usage.

Off-Module Channel Spacing











4' Ceiling Module

6" Channel

System 862

24" x 24" Infill Panel

Selector

Channel Width	Ceiling Module	On-Center Channel Spacing	Infill Panels	Panel Edge	Suspension System
6"	4' (48")	4' - 6" (54")	HALCYON 24" x 24" x 1"	FL 	DXT, DXI
				SL 	DX
				SQ 	DX, DXT
			MARS 24" x 24" x 3/4"	FLB 	DXT, DXI
				SLT 	DX
				SQ 	DX, DXT
			MARS High-NRC 24" x 24" x 7/8"	FLB 	DXT, DXI
				SLT 	DX
				SQ 	DX, DXT
			PANZ Metal Panels, Solid 24" x 24"	FL 	DXT, DXI

Module Layout

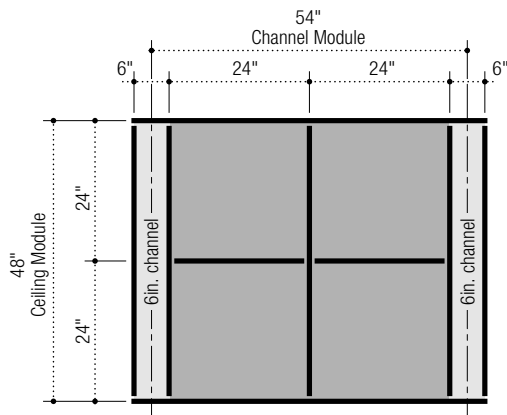

Panel Layout

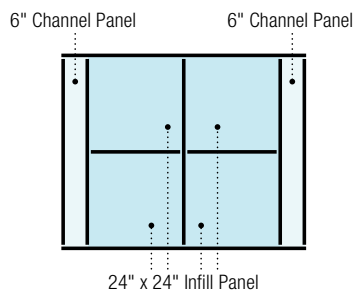

Suspension System Layout

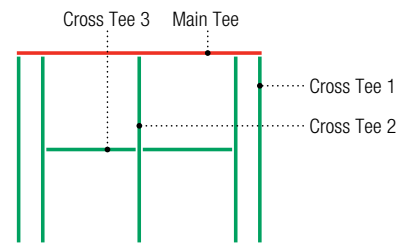

Order Information
System 862

4' Ceiling Module

6" Channel
24" x 24" Infill Panel



Step 1. Select Panels

Step 2. Select Edge for Panels

			FL/FLB		SL/SLT		SQ	
			Edge	Item No.	Edge	Item No.	Edge	Item No.
Infill Panels	HALCYON	24" x 24" x 1"	FL	<input type="checkbox"/> 98225	SL	<input type="checkbox"/> 98223	SQ	<input type="checkbox"/> 98221
	MARS	24" x 24" x 3/4"	FLB	<input type="checkbox"/> 86985	SLT	<input type="checkbox"/> 86785	SQ	<input type="checkbox"/> 86185
	MARS High-NRC	24" x 24" x 7/8"	FLB	<input type="checkbox"/> 87100	SLT	<input type="checkbox"/> 87200	SQ	<input type="checkbox"/> 86100
	PANZ Metal Panels, Solid	24" x 24"	FL	<input type="checkbox"/> 275616				

Channel Panels	HALCYON	6" x 48" x 1"	FL	<input type="checkbox"/> 97572	SL	<input type="checkbox"/> 99271	SQ	<input type="checkbox"/> 97227
	MARS	6" x 48" x 3/4"	FLB	<input type="checkbox"/> 88887	SLT	<input type="checkbox"/> 86542	SQ	<input type="checkbox"/> 86325
	MARS High-NRC	6" x 48" x 7/8"	FLB	<input type="checkbox"/> 86331	SLT	<input type="checkbox"/> 86442	SQ	<input type="checkbox"/> 86404
	PANZ Metal Panels, Solid	6" x 48"	FL	<input type="checkbox"/> 256820	SL	<input type="checkbox"/> 256819	SQ	<input type="checkbox"/> 256768
	Panz Metal Panels, Perf C116	6" x 48"	FL	<input type="checkbox"/> 256062	SL	<input type="checkbox"/> 257248	SQ	<input type="checkbox"/> 256397
	Panz Metal Panels, Perf C116D	6" x 48"	FL	<input type="checkbox"/> 257585	SL	<input type="checkbox"/> 257584	SQ	<input type="checkbox"/> 257406

Step 3. Select Corresponding Grid for Selected Panels

			Qty	Item No.	Qty	Item No.	Qty	Item No.
Suspension Systems	CENTRICITEE DXT	Main Tee		<input type="checkbox"/> DXT24				<input type="checkbox"/> DXT24
		Cross Tee 1	2	<input type="checkbox"/> DXT424			2	<input type="checkbox"/> DXT424
		Cross Tee 2	1	<input type="checkbox"/> DXT424			1	<input type="checkbox"/> DXT424
		Cross Tee 3	2	<input type="checkbox"/> DXT222			2	<input type="checkbox"/> DXT222
	IDENTITEE DXI	Main Tee		<input type="checkbox"/> DXI24				
		Cross Tee 1	2	<input type="checkbox"/> DXI424				
		Cross Tee 2	1	<input type="checkbox"/> DXI424				
		Cross Tee 3	2	<input type="checkbox"/> DXI222				
	DONN DX	Main Tee				<input type="checkbox"/> DX/DXL24		<input type="checkbox"/> DX/DXL24
		Cross Tee 1			2	<input type="checkbox"/> DX422	2	<input type="checkbox"/> DX422
		Cross Tee 2			1	<input type="checkbox"/> DX422	1	<input type="checkbox"/> DX422
		Cross Tee 3			2	<input type="checkbox"/> DX216	2	<input type="checkbox"/> DX216

Suspension System Estimator

	Length	Sq. Ft.	Main Tee Usage Per Sq. Ft.	Cross Tee 1 Usage Per Sq. Ft.	Cross Tee 2 Usage Per Sq. Ft.	Cross Tee 3 Usage Per Sq. Ft.
System Module	54"	18	0.25	0.44	0.22	0.22

Note: Multiply the ceiling area (SF) by the Usage Factor (UF). This calculation will determine lineal footage of suspension system components required. Please refer to the front of this catalogue or IC592 for stabilizer bar usage.



Off-Module Channel Spacing

4' Ceiling Module

System 527

4" Channel
48" x 48" Infill Panel

Selector

Channel Width	Ceiling Module	On-Center Channel Spacing	Infill Panels	Panel Edge	Suspension System
4"	4' (48")	4' - 4" (52")	HALCYON 48" x 48" x 1"	FL 	DXT, DXI
				SL 	DX
				SQ 	DX

Module Layout

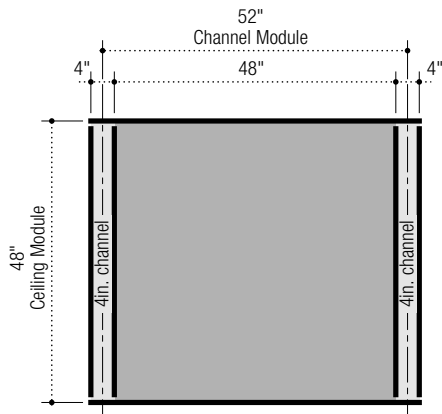

Panel Layout

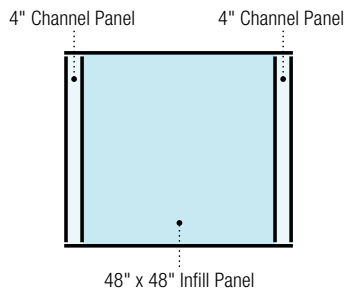

Suspension System Layout

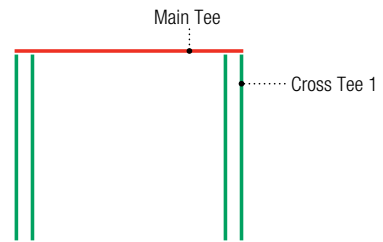

Order Information
System 527

4' Ceiling Module

4" Channel
48" x 48" Infill Panel



Step 1. Select Panels

Step 2. Select Edge for Panels

			FL/FLB		SL/SLT		SQ	
			Edge	Item No.	Edge	Item No.	Edge	Item No.
Infill Panels	HALCYON	48" x 48" x 1"	FL	<input type="checkbox"/> 98445	SL	<input type="checkbox"/> 98443	SQ	<input type="checkbox"/> 98441

Channel Panels	HALCYON	4" x 48" x 1"	FL	<input type="checkbox"/> 97460	SL	<input type="checkbox"/> 97430	SQ	<input type="checkbox"/> 97402
	HALCYON	6" x 48" x 1"	FL	<input type="checkbox"/> 98198	SL	<input type="checkbox"/> 99271	SQ	<input type="checkbox"/> 97227

Step 3. Select Corresponding Grid for Selected Panels

			Qty	Item No.	Qty	Item No.	Qty	Item No.
Suspension Systems	CENTRICITEE DXT	Main Tee		<input type="checkbox"/> DXT24SP103				
		Cross Tee 1	2	<input type="checkbox"/> DXT424				
	IDENTITEE DXI	Main Tee		<input type="checkbox"/> DXI24SP103				
		Cross Tee 1	2	<input type="checkbox"/> DXI424				
	DONN DX	Main Tee			<input type="checkbox"/> DX24SP103		<input type="checkbox"/> DX24SP103	
		Cross Tee 1			2	<input type="checkbox"/> DX422	2	<input type="checkbox"/> DX422

Suspension System Estimator

	Length	Sq. Ft.	Main Tee Usage Per Sq. Ft.	Cross Tee 1 Usage Per Sq. Ft.	
System Module	52"	17.333	0.25	0.46	

Note: Multiply the ceiling area (SF) by the Usage Factor (UF). This calculation will determine lineal footage of suspension system components required. Please refer to the front of this catalogue or IC592 for stabilizer bar usage.

Off-Module Channel Spacing



4' Ceiling Module

6" Channel

System 244

48" x 48" Infill Panel

Selector

Channel Width	Ceiling Module	On-Center Channel Spacing	Infill Panels	Panel Edge	Suspension System
6"	4' (48")	4' - 6" (54")	HALCYON 48" x 48" x 1"	FL 	DXT, DXI
				SL 	DX
				SQ 	DX

Module Layout

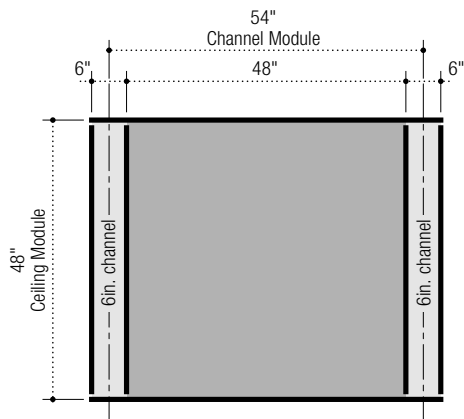

Panel Layout

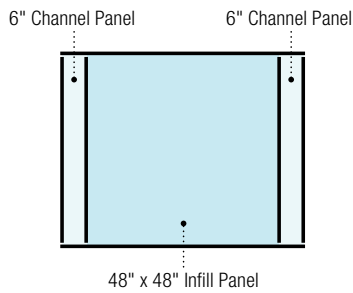

Suspension System Layout

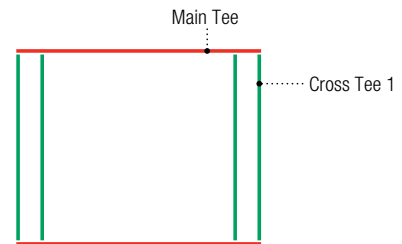

Order Information
System 244

4' Ceiling Module

6" Channel
48" x 48" Infill Panel



Step 1. Select Panels

Step 2. Select Edge for Panels

			FL/FLB		SL/SLT		SQ		
			Edge	Item No.	Edge	Item No.	Edge	Item No.	
Infill Panels	HALCYON	48" x 48" x 1"	FL	<input type="checkbox"/> 98445	SL	<input type="checkbox"/> 98443	SQ	<input type="checkbox"/> 98441	
	Channel Panels	HALCYON	6" x 48" x 1"	FL	<input type="checkbox"/> 98198	SL	<input type="checkbox"/> 99271	SQ	<input type="checkbox"/> 97227
		PANZ Metal Panels, Solid	6" x 48"	FL	<input type="checkbox"/> 256820	SL	<input type="checkbox"/> 256819	SQ	<input type="checkbox"/> 256768
		Panz Metal Panels, Perf C116	6" x 48"	FL	<input type="checkbox"/> 256062	SL	<input type="checkbox"/> 257248	SQ	<input type="checkbox"/> 256397
	Panz Metal Panels, Perf C116D	6" x 48"	FL	<input type="checkbox"/> 257585	SL	<input type="checkbox"/> 257584	SQ	<input type="checkbox"/> 257406	

Step 3. Select Corresponding Grid for Selected Panels

			Qty	Item No.	Qty	Item No.	Qty	Item No.
			Suspension Systems	CENTRICITEE DXT	Main Tee		<input type="checkbox"/> DXT24	
Cross Tee 1	2	<input type="checkbox"/> DXT424						
IDENTITEE DXI	Main Tee			<input type="checkbox"/> DXI24				
	Cross Tee 1	2		<input type="checkbox"/> DXI424				
DONN DX	Main Tee					<input type="checkbox"/> DX/DXL24		<input type="checkbox"/> DX/DXL24
	Cross Tee 1				2	<input type="checkbox"/> DX422	2	<input type="checkbox"/> DX422

Suspension System Estimator

	Length	Sq. Ft.	Main Tee Usage Per Sq. Ft.	Cross Tee 1 Usage Per Sq. Ft.
System Module	54"	18	0.25	0.44

Note: Multiply the ceiling area (SF) by the Usage Factor (UF). This calculation will determine lineal footage of suspension system components required. Please refer to the front of this catalogue or IC592 for stabilizer bar usage.

Off-Module Channel Spacing





System 529

4' Ceiling Module

4" Channel

72" x 24" Infill Panel

Selector

Channel Width	Ceiling Module	On-Center Channel Spacing	Infill Panels	Panel Edge	Suspension System
4"	4' (48")	6' - 4" (76")	HALCYON 72" x 24" x 1"	FL 	DXT, DXI
			MARS 72" x 24" x 3/4"	FLB 	DXT, DXI
			MARS High-NRC 72" x 24" x 7/8"	FLB 	DXT, DXI
			PANZ Metal Panels, Solid 72" x 24"	FL 	DXT, DXI

Module Layout

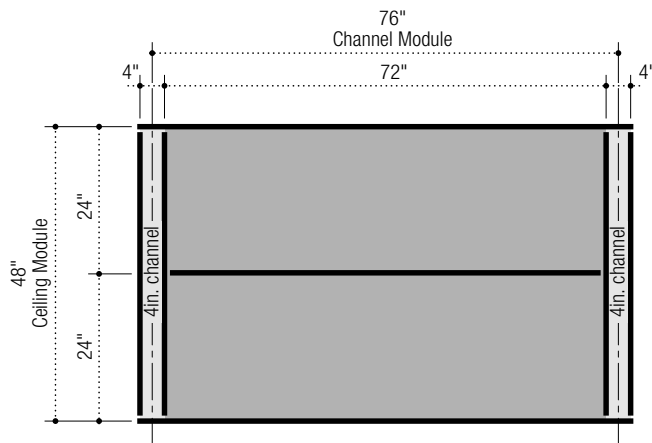

Panel Layout

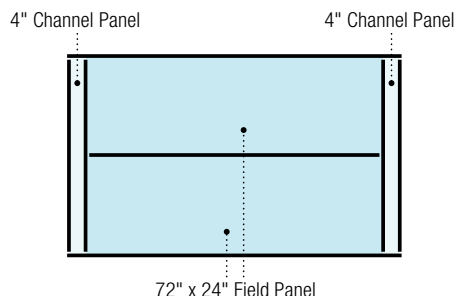

Suspension System Layout

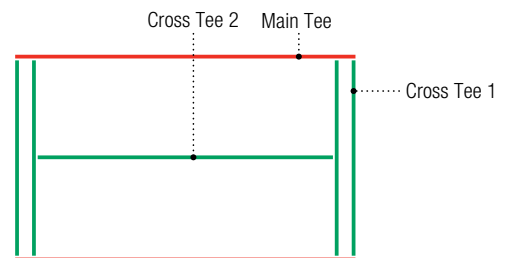

Order Information
System 529

4' Ceiling Module

4" Channel
72" x 24" Infill Panel



Step 1. Select Panels

Step 2. Select Edge for Panels

			FL/FLB		SL/SLT		SQ	
			Edge	Item No.	Edge	Item No.	Edge	Item No.
Infill Panels	HALCYON	72" x 24" x 1"	FL	<input type="checkbox"/> 98348				
	MARS	72" x 24" x 3/4"	FLB	<input type="checkbox"/> 88996				
	MARS High-NRC	72" x 24" x 7/8"	FLB	<input type="checkbox"/> 89670				
	PANZ Metal Panels, Solid	72" x 24"	FL	<input type="checkbox"/> 212192				

Channel Panels	HALCYON	4" x 48" x 1"	FL	<input type="checkbox"/> 97460	SL	<input type="checkbox"/> 97430	SQ	<input type="checkbox"/> 97402
	MARS	4" x 48" x 3/4"	FLB	<input type="checkbox"/> 86568				
	MARS High-NRC	4" x 48" x 7/8"	FLB	<input type="checkbox"/> 86475				
	PANZ Metal Panels, Solid	4" x 48"	FL	<input type="checkbox"/> 202636				

Step 3. Select Corresponding Grid for Selected Panels

			Qty	Item No.	Qty	Item No.	Qty	Item No.
Suspension Systems	CENTRICITEE DXT	Main Tee		<input type="checkbox"/> DXTSP110				
		Cross Tee 1	2	<input type="checkbox"/> DXT424				
		Cross Tee 2	1	<input type="checkbox"/> DXT624				
	IDENTITEE DXI	Main Tee		<input type="checkbox"/> DXISP110				
		Cross Tee 1	2	<input type="checkbox"/> DXI424				
		Cross Tee 2	1	<input type="checkbox"/> DXI624				

Suspension System Estimator

	Length	Sq. Ft.	Main Tee Usage Per Sq. Ft.	Cross Tee 1 Usage Per Sq. Ft.	Cross Tee 2 Usage Per Sq. Ft.	
System Module	78"	26	0.25	0.31	0.23	











Note: Multiply the ceiling area (SF) by the Usage Factor (UF). This calculation will determine lineal footage of suspension system components required. Please refer to the front of this catalogue or IC592 for stabilizer bar usage.

Off-Module Channel Spacing

4' Ceiling Module

6" Channel
72" x 24" Infill Panel

Selector

Channel Width	Ceiling Module	On-Center Channel Spacing	Infill Panels	Panel Edge	Suspension System		
6"	4' (48")	6' - 6" (78")	HALCYON	72" x 24" x 1"	FL 	DXT, DXI	
					SL 	DX	
					SQ 	DX	
			MARS	72" x 24" x 3/4"	FLB 	DXT, DXI	
					SLT 	DX	
					SQ 	DX	
			MARS High-NRC	72" x 24" x 7/8"	FLB 	DXT, DXI	
					SLT 	DX	
					SQ 	DX	
			PANZ Metal Panels, Solid		72" x 24"	FL 	DXT, DXI

Module Layout

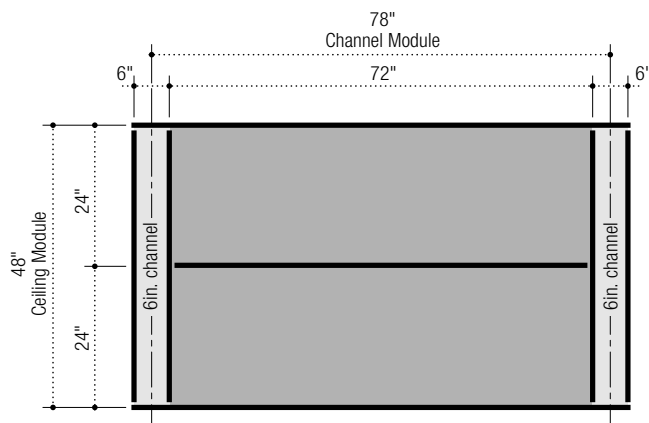

Panel Layout

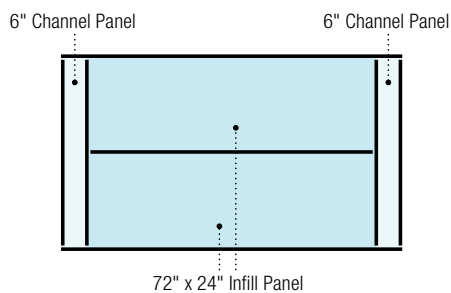

Suspension System Layout

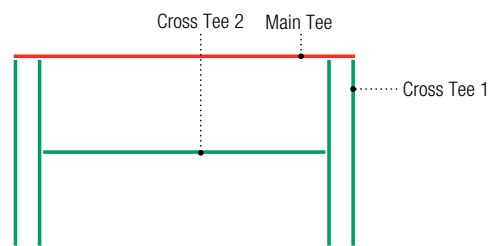

Order Information
System 755

4' Ceiling Module

6" Channel
72" x 24" Infill Panel



Step 1. Select Panels

Step 2. Select Edge for Panels

			FL/FLB		SL/SLT		SQ	
			Edge	Item No.	Edge	Item No.	Edge	Item No.
Infill Panels	HALCYON	72" x 24" x 1"	FL	<input type="checkbox"/> 98348	SL	<input type="checkbox"/> 99268	SQ	<input type="checkbox"/> 99234
	MARS	72" x 24" x 3/4"	FLB	<input type="checkbox"/> 88996	SLT	<input type="checkbox"/> 86166	SQ	<input type="checkbox"/> 86223
	MARS High-NRC	72" x 24" x 7/8"	FLB	<input type="checkbox"/> 89670	SLT	<input type="checkbox"/> 89660	SQ	<input type="checkbox"/> 86360
	PANZ Metal Panels, Solid	72" x 24"	FL	<input type="checkbox"/> 212192				

Channel Panels	HALCYON	6" x 48" x 1"	FL	<input type="checkbox"/> 98198	SL	<input type="checkbox"/> 99271	SQ	<input type="checkbox"/> 97227
	MARS	6" x 48" x 3/4"	FLB	<input type="checkbox"/> 88887	SLT	<input type="checkbox"/> 86542	SQ	<input type="checkbox"/> 86325
	MARS High-NRC	6" x 48" x 7/8"	FLB	<input type="checkbox"/> 86331	SLT	<input type="checkbox"/> 86442	SQ	<input type="checkbox"/> 86404
	PANZ Metal Panels, Solid	6" x 48"	FL	<input type="checkbox"/> 256820	SL	<input type="checkbox"/> 256819	SQ	<input type="checkbox"/> 256768
	Panz Metal Panels, Perf C116	6" x 48"	FL	<input type="checkbox"/> 256062	SL	<input type="checkbox"/> 257248	SQ	<input type="checkbox"/> 256397
	Panz Metal Panels, Perf C116D	6" x 48"	FL	<input type="checkbox"/> 257585	SL	<input type="checkbox"/> 257584	SQ	<input type="checkbox"/> 257406

Step 3. Select Corresponding Grid for Selected Panels

			Qty	Item No.	Qty	Item No.	Qty	Item No.
Suspension Systems	CENTRICITEE DXT	Main Tee		<input type="checkbox"/> DXT24				
		Cross Tee 1	2	<input type="checkbox"/> DXT424				
		Cross Tee 2	1	<input type="checkbox"/> DXT624				
	IDENTITEE DXI	Main Tee		<input type="checkbox"/> DXI24				
		Cross Tee 1	2	<input type="checkbox"/> DXI424				
		Cross Tee 2	1	<input type="checkbox"/> DXI624				
	DONN DX	Main Tee				<input type="checkbox"/> DX/DXL24		<input type="checkbox"/> DX/DXL24
		Cross Tee 1			2	<input type="checkbox"/> DX422	2	<input type="checkbox"/> DX422
		Cross Tee 2			1	<input type="checkbox"/> DX624	1	<input type="checkbox"/> DX624

Suspension System Estimator

	Length	Sq. Ft.	Main Tee Usage Per Sq. Ft.	Cross Tee 1 Usage Per Sq. Ft.	Cross Tee 2 Usage Per Sq. Ft.	
System Module	78"	26	0.25	0.31	0.23	











Note: Multiply the ceiling area (SF) by the Usage Factor (UF). This calculation will determine lineal footage of suspension system components required. Please refer to the front of this catalogue or IC592 for stabilizer bar usage.

Off-Module Channel Spacing

4' Ceiling Module

6" Channel
24" x 24" Infill Panel

Selector

Channel Width	Ceiling Module	On-Center Channel Spacing	Infill Panels	Panel Edge	Suspension System
6"	4' (48")	6' - 6" (78")	HALCYON 24" x 24" x 1"	FL 	DXT, DXI
				SL 	DX
				SQ 	DX, DXT
			MARS 24" x 24" x 3/4"	FLB 	DXT, DXI
				SLT 	DX
				SQ 	DX, DXT
			MARS High-NRC 24" x 24" x 7/8"	FLB 	DXT, DXI
				SLT 	DX
				SQ 	DX, DXT
			PANZ Metal Panels, Solid 24" x 24"	FL 	DXT, DXI

Module Layout

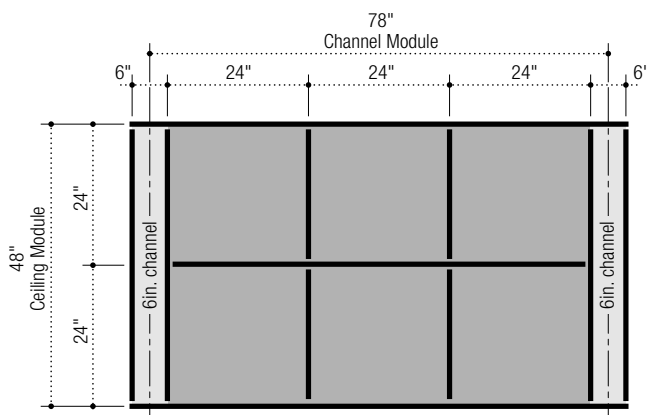

Panel Layout

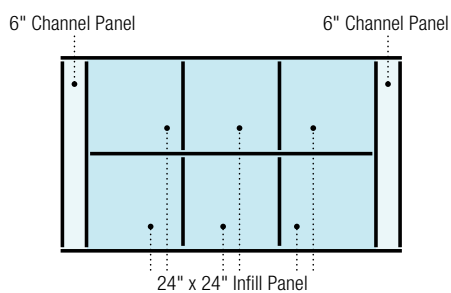

Suspension System Layout

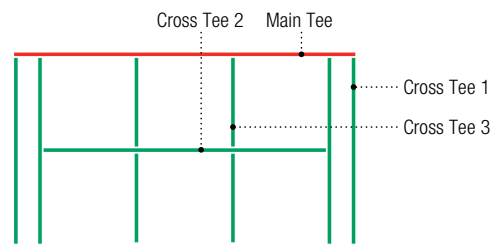

Order Information
System 574

4' Ceiling Module

6" Channel
24" x 24" Infill Panel

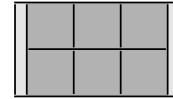

Step 1. Select Panels

Step 2. Select Edge for Panels

			FL/FLB		SL/SLT		SQ	
			Edge	Item No.	Edge	Item No.	Edge	Item No.
Infill Panels	HALCYON	24" x 24" x 1"	FL	<input type="checkbox"/> 98225	SL	<input type="checkbox"/> 98223	SQ	<input type="checkbox"/> 98221
	MARS	24" x 24" x 3/4"	FLB	<input type="checkbox"/> 86985	SLT	<input type="checkbox"/> 86785	SQ	<input type="checkbox"/> 86185
	MARS High-NRC	24" x 24" x 7/8"	FLB	<input type="checkbox"/> 87100	SLT	<input type="checkbox"/> 87200	SQ	<input type="checkbox"/> 86100
	PANZ Metal Panels, Solid	24" x 24"	FL	<input type="checkbox"/> 275616				

Channel Panels	MARS	4" x 48" x 3/4"	FLB	<input type="checkbox"/> 86568	SLT	<input type="checkbox"/> 86540	SQ	<input type="checkbox"/> 86514
	MARS High-NRC	4" x 48" x 7/8"	FLB	<input type="checkbox"/> 86475	SLT	<input type="checkbox"/> 86440	SQ	<input type="checkbox"/> 86402
	PANZ Metal Panels, Solid	4" x 48"	FL	<input type="checkbox"/> 202636				

Step 3. Select Corresponding Grid for Selected Panels

			Qty	Item No.	Qty	Item No.	Qty	Item No.
Suspension Systems	CENTRICITEE DXT	Main Tee		<input type="checkbox"/> DXT24				<input type="checkbox"/> DXT24
		Cross Tee 1	2	<input type="checkbox"/> DXT424			2	<input type="checkbox"/> DXT424
		Cross Tee 2	2	<input type="checkbox"/> DXT424			2	<input type="checkbox"/> DXT424
		Cross Tee 3	3	<input type="checkbox"/> DXT222			3	<input type="checkbox"/> DXT222
	IDENTITEE DXI	Main Tee		<input type="checkbox"/> DXI24				
		Cross Tee 1	2	<input type="checkbox"/> DXI424				
		Cross Tee 2	3	<input type="checkbox"/> DXI424				
		Cross Tee 3	3	<input type="checkbox"/> DXI222				
	DONN DX	Main Tee				<input type="checkbox"/> DX/DXL24		<input type="checkbox"/> DX/DXL24
		Cross Tee 1			2	<input type="checkbox"/> DX422	2	<input type="checkbox"/> DX422
		Cross Tee 2			2	<input type="checkbox"/> DX422	2	<input type="checkbox"/> DX422
		Cross Tee 3			3	<input type="checkbox"/> DX216	3	<input type="checkbox"/> DX216

Suspension System Estimator

	Length	Sq. Ft.	Main Tee Usage Per Sq. Ft.	Cross Tee 1 Usage Per Sq. Ft.	Cross Tee 2 Usage Per Sq. Ft.	Cross Tee 3 Usage Per Sq. Ft.
System Module	78"	26	0.25	0.31	0.31	0.23

Note: Multiply the ceiling area (SF) by the Usage Factor (UF). This calculation will determine lineal footage of suspension system components required. Please refer to the front of this catalogue or IC592 for stabilizer bar usage.



Off-Module Channel Spacing

4' Ceiling Module

System 497

4" Channel
42" x 48" Infill Panel

Selector

Channel Width	Ceiling Module	On-Center Channel Spacing	Infill Panels	Panel Edge	Suspension System
6"	4' (48")	7'-6" (80")	HALCYON 42" x 48" x 1"	FL 	DXT, DXI
				SL 	DX
				SQ 	DX

Module Layout

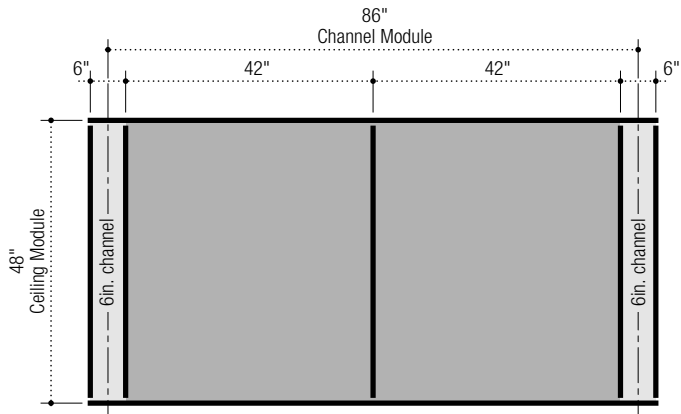

Panel Layout

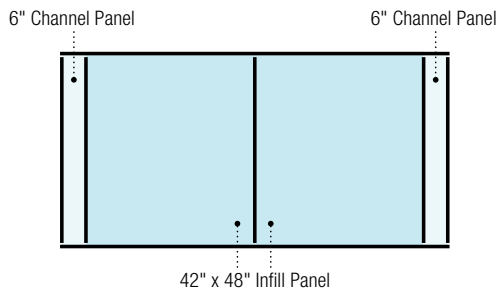

Suspension System Layout

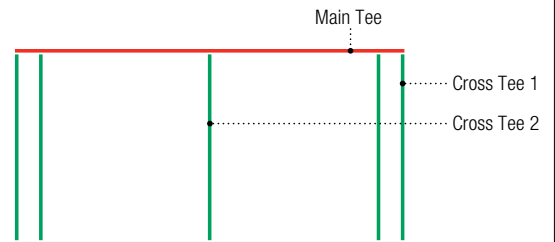

Order Information
System 497

4' Ceiling Module

4" Channel
42" x 48" Infill Panel



Step 1. Select Panels

Step 2. Select Edge for Panels

			FL/FLB		SL/SLT		SQ	
			Edge	Item No.	Edge	Item No.	Edge	Item No.
Infill Panels	HALCYON	42" x 48" x 1"	FL	<input type="checkbox"/> 98343	SL	<input type="checkbox"/> 97454	SQ	<input type="checkbox"/> 97424

Channel Panels	HALCYON	6" x 48" x 1"	FL	<input type="checkbox"/> 98198	SL	<input type="checkbox"/> 99271	SQ	<input type="checkbox"/> 97227
	PANZ Metal Panels, Solid	6" x 48"	FL	<input type="checkbox"/> 256820	SL	<input type="checkbox"/> 256819	SQ	<input type="checkbox"/> 256768
	Panz Metal Panels, Perf C116	6" x 48"	FL	<input type="checkbox"/> 256062	SL	<input type="checkbox"/> 257248	SQ	<input type="checkbox"/> 256397
	Panz Metal Panels, Perf C116D	6" x 48"	FL	<input type="checkbox"/> 257585	SL	<input type="checkbox"/> 257584	SQ	<input type="checkbox"/> 257406

Step 3. Select Corresponding Grid for Selected Panels

			Qty	Item No.	Qty	Item No.	Qty	Item No.
Suspension Systems	CENTRICITEE DXT	Main Tee		<input type="checkbox"/> DXT24				
		Cross Tee 1	2	<input type="checkbox"/> DXT424				
		Cross Tee 2	1	<input type="checkbox"/> DXT424				
	IDENTITEE DXI	Main Tee		<input type="checkbox"/> DXI24				
		Cross Tee 1	2	<input type="checkbox"/> DXI424				
		Cross Tee 2	1	<input type="checkbox"/> DXI424				
	DONN DX	Main Tee				<input type="checkbox"/> DX/DXL24		<input type="checkbox"/> DX/DXL24
		Cross Tee 1			2	<input type="checkbox"/> DX422	2	<input type="checkbox"/> DX422
		Cross Tee 2			1	<input type="checkbox"/> DX422	1	<input type="checkbox"/> DX422

Suspension System Estimator

	Length	Sq. Ft.	Main Tee Usage Per Sq. Ft.	Cross Tee 1 Usage Per Sq. Ft.	Cross Tee 2 Usage Per Sq. Ft.	
System Module	90"	30	0.25	0.27	0.13	



Note: Multiply the ceiling area (SF) by the Usage Factor (UF). This calculation will determine lineal footage of suspension system components required. Please refer to the front of this catalogue or IC592 for stabilizer bar usage.

Off-Module Channel Spacing

4' Ceiling Module

4" Channel
96" x 24" Infill Panel

Selector

Channel Width	Ceiling Module	On-Center Channel Spacing	Infill Panels	Panel Edge	Suspension System
4"	4' (48")	8' - 4" (100")	HALCYON 96" x 24" x 1"	FL 	DXT, DXI
				SL 	DX
				SQ 	DX

Module Layout

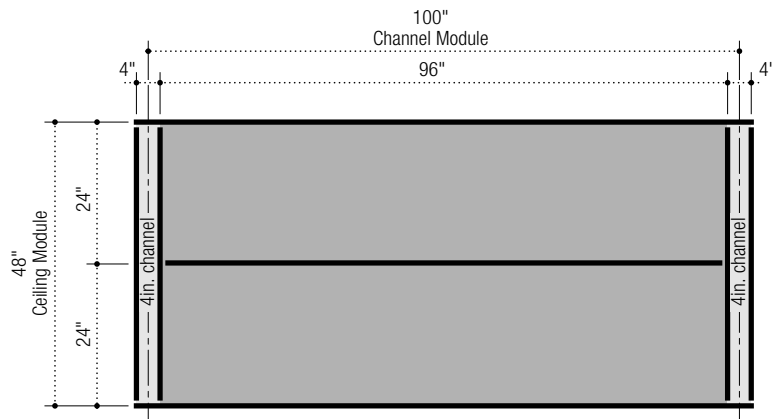

Panel Layout

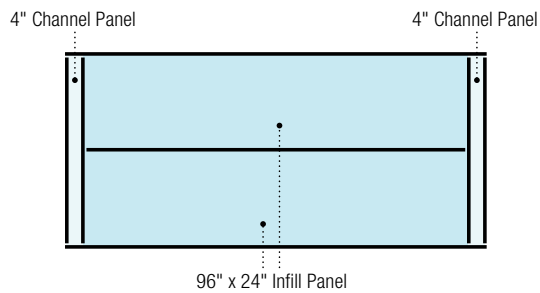

Suspension System Layout

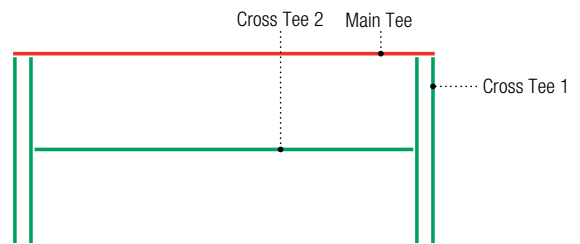

Order Information
System 722

4' Ceiling Module

4" Channel
96" x 24" Infill Panel



Step 1. Select Panels

Step 2. Select Edge for Panels

			FL/FLB		SL/SLT		SQ	
			Edge	Item No.	Edge	Item No.	Edge	Item No.
Infill Panels	HALCYON	96" x 24" x 1"	FL	<input type="checkbox"/> 98197	SL	<input type="checkbox"/> 99269	SQ	<input type="checkbox"/> 98351

Channel Panels	HALCYON	4" x 48" x 1"	FL	<input type="checkbox"/> 97460	SL	<input type="checkbox"/> 97430	SQ	<input type="checkbox"/> 97402
-----------------------	---------	---------------	----	--------------------------------	----	--------------------------------	----	--------------------------------

Step 3. Select Corresponding Grid for Selected Panels

			Qty	Item No.	Qty	Item No.	Qty	Item No.
Suspension Systems	CENTRICITEE DXT	Main Tee		<input type="checkbox"/> DXT24SP108				
		Cross Tee 1	2	<input type="checkbox"/> DXT424				
		Cross Tee 2	1	<input type="checkbox"/> DXT824				
	IDENTITEE DXI	Main Tee		<input type="checkbox"/> DXI24SP108				
		Cross Tee 1	2	<input type="checkbox"/> DXI424				
		Cross Tee 2	1	<input type="checkbox"/> DXI824				
	DONN DX	Main Tee			<input type="checkbox"/> DX24SP108		<input type="checkbox"/> DX24SP108	
		Cross Tee 1			2	<input type="checkbox"/> DX422	2	<input type="checkbox"/> DX422
		Cross Tee 2			1	<input type="checkbox"/> DX824	1	<input type="checkbox"/> DX824

Suspension System Estimator

	Length	Sq. Ft.	Main Tee Usage Per Sq. Ft.	Cross Tee 1 Usage Per Sq. Ft.	Cross Tee 2 Usage Per Sq. Ft.	
System Module	100"	33.333	0.25	0.24	0.24	









Note: Multiply the ceiling area (SF) by the Usage Factor (UF). This calculation will determine lineal footage of suspension system components required. Please refer to the front of this catalogue or IC592 for stabilizer bar usage.

Off-Module Channel Spacing

4' Ceiling Module

6" Channel
48" x 48" Infill Panel

Selector

Channel Width	Ceiling Module	On-Center Channel Spacing	Infill Panels	Panel Edge	Suspension System
6"	4' (48")	8' - 6" (102")	HALCYON 48" x 48" x 1"	FL 	DXT, DXI
				SL 	DX
				SQ 	DX
			MARS 48" x 48 x 3/4"	FLB 	DXT, DXI
				SLT 	DX
				SQ 	DX
			MARS High-NRC 48" x 48" x 7/8"	FLB 	DXT, DXI
				SLT 	DX
				SQ 	DX

Module Layout

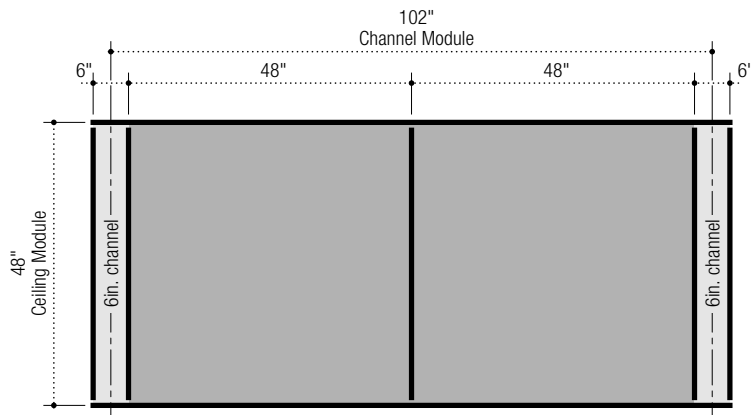

Panel Layout

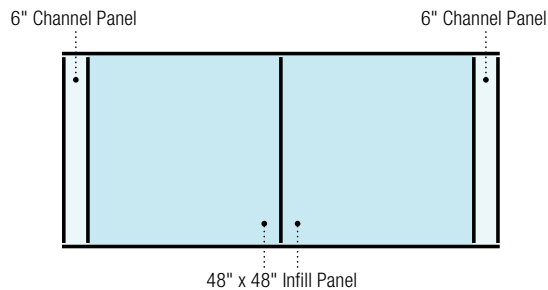

Suspension System Layout

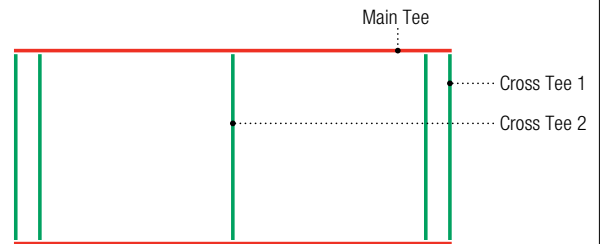

Order Information
System 754

4' Ceiling Module

6" Channel
48" x 48" Infill Panel



Step 1. Select Panels

Step 2. Select Edge for Panels

			FL/FLB		SL/SLT		SQ	
			Edge	Item No.	Edge	Item No.	Edge	Item No.
Infill Panels	HALCYON	48" x 48" x 1"	FL	<input type="checkbox"/> 98445	SL	<input type="checkbox"/> 98443	SQ	<input type="checkbox"/> 98441

Channel Panels	HALCYON	6" x 48" x 1"	FL	<input type="checkbox"/> 98198	SL	<input type="checkbox"/> 99271	SQ	<input type="checkbox"/> 97227
	PANZ Metal Panels, Solid	6" x 48"	FL	<input type="checkbox"/> 256820	SL	<input type="checkbox"/> 256819	SQ	<input type="checkbox"/> 256768
	Panz Metal Panels, Perf C116	6" x 48"	FL	<input type="checkbox"/> 256062	SL	<input type="checkbox"/> 257248	SQ	<input type="checkbox"/> 256397
	Panz Metal Panels, Perf C116D	6" x 48"	FL	<input type="checkbox"/> 257585	SL	<input type="checkbox"/> 257584	SQ	<input type="checkbox"/> 257406

Step 3. Select Corresponding Grid for Selected Panels

			Qty	Item No.	Qty	Item No.	Qty	Item No.
Suspension Systems	CENTRICITEE DXT	Main Tee		<input type="checkbox"/> DXT24				
		Cross Tee 1	2	<input type="checkbox"/> DXT424				
		Cross Tee 2	1	<input type="checkbox"/> DXT424				
	IDENTITEE DXI	Main Tee		<input type="checkbox"/> DXI24				
		Cross Tee 1	2	<input type="checkbox"/> DXI424				
		Cross Tee 2	1	<input type="checkbox"/> DXI424				
	DONN DX	Main Tee				<input type="checkbox"/> DX/DXL24		<input type="checkbox"/> DX/DXL24
		Cross Tee 1			2	<input type="checkbox"/> DX422	2	<input type="checkbox"/> DX422
		Cross Tee 2			1	<input type="checkbox"/> DX422	1	<input type="checkbox"/> DX422

Suspension System Estimator

	Length	Sq. Ft.	Main Tee Usage Per Sq. Ft.	Cross Tee 1 Usage Per Sq. Ft.	Cross Tee 2 Usage Per Sq. Ft.	
System Module	102"	34	0.25	0.24	0.12	



Note: Multiply the ceiling area (SF) by the Usage Factor (UF). This calculation will determine lineal footage of suspension system components required. Please refer to the front of this catalogue or IC592 for stabilizer bar usage.

Off-Module Channel Spacing

4' Ceiling Module

6" Channel
96" x 24" Infill Panel

Selector

Channel Width	Ceiling Module	On-Center Channel Spacing	Infill Panels	Panel Edge	Suspension System
6"	4' (48")	8'-6" (102")	HALCYON 96" x 24" x 1"	FL 	DXT, DXI
				SL 	DX
				SQ 	DX

Module Layout

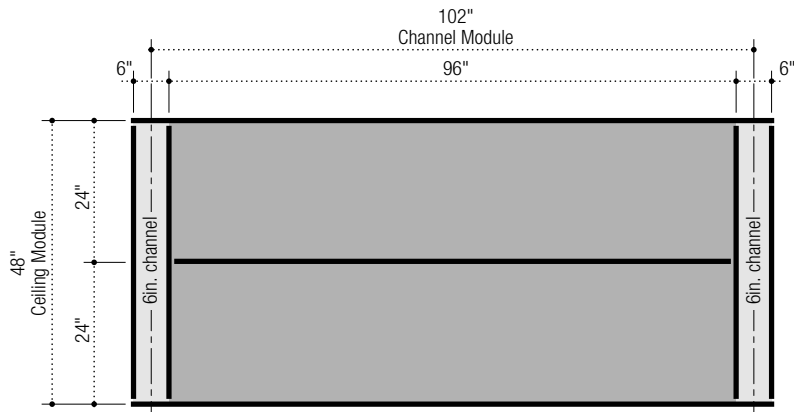

Panel Layout

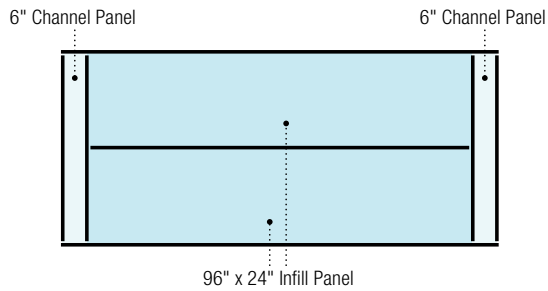

Suspension System Layout

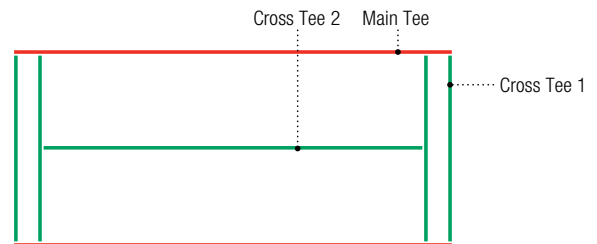

Order Information
System 664

4' Ceiling Module

6" Channel
96" x 24" Infill Panel



Step 1. Select Panels

Step 2. Select Edge for Panels

			FL/FLB		SL/SLT		SQ	
			Edge	Item No.	Edge	Item No.	Edge	Item No.
Infill Panels	HALCYON	96" x 24" x 1"	FL	<input type="checkbox"/> 98197	SL	<input type="checkbox"/> 99269	SQ	<input type="checkbox"/> 98351

			FL/FLB		SL/SLT		SQ	
			Edge	Item No.	Edge	Item No.	Edge	Item No.
Channel Panels	HALCYON	6" x 48" x 1"	FL	<input type="checkbox"/> 98198	SL	<input type="checkbox"/> 99271	SQ	<input type="checkbox"/> 97227
	PANZ Metal Panels, Solid	6" x 48"	FL	<input type="checkbox"/> 256820	SL	<input type="checkbox"/> 256819	SQ	<input type="checkbox"/> 256768
	Panz Metal Panels, Perf C116	6" x 48"	FL	<input type="checkbox"/> 256062	SL	<input type="checkbox"/> 257248	SQ	<input type="checkbox"/> 256397
	Panz Metal Panels, Perf C116D	6" x 48"	FL	<input type="checkbox"/> 257585	SL	<input type="checkbox"/> 257584	SQ	<input type="checkbox"/> 257406

Step 3. Select Corresponding Grid for Selected Panels

			Qty	Item No.	Qty	Item No.	Qty	Item No.
			Suspension Systems	CENTRICITEE DXT	Main Tee		<input type="checkbox"/> DXT24	
Cross Tee 1	2	<input type="checkbox"/> DXT424						
Cross Tee 2	1	<input type="checkbox"/> DXT824						
IDENTITEE DXI	Main Tee			<input type="checkbox"/> DXI24				
	Cross Tee 1	2		<input type="checkbox"/> DXI424				
	Cross Tee 2	1		<input type="checkbox"/> DXI824				
DONN DX	Main Tee					<input type="checkbox"/> DX/DXL24		<input type="checkbox"/> DX/DXL24
	Cross Tee 1				2	<input type="checkbox"/> DX422	2	<input type="checkbox"/> DX422
	Cross Tee 2				1	<input type="checkbox"/> DX824	1	<input type="checkbox"/> DX824

Suspension System Estimator

	Length	Sq. Ft.	Main Tee Usage Per Sq. Ft.	Cross Tee 1 Usage Per Sq. Ft.	Cross Tee 2 Usage Per Sq. Ft.	
System Module	102"	34	0.25	0.24	0.12	

Note: Multiply the ceiling area (SF) by the Usage Factor (UF). This calculation will determine lineal footage of suspension system components required. Please refer to the front of this catalogue or IC592 for stabilizer bar usage.

Off-Module Channel Spacing



4' Ceiling Module

6" Channel

System 979

96" x 48" Infill Panel

Selector

Channel Width	Ceiling Module	On-Center Channel Spacing	Infill Panels	Panel Edge	Suspension System
6"	4' (48")	8'-6" (102")	HALCYON 96" x 48" x 1"	SL  SQ 	DX DX

Module Layout

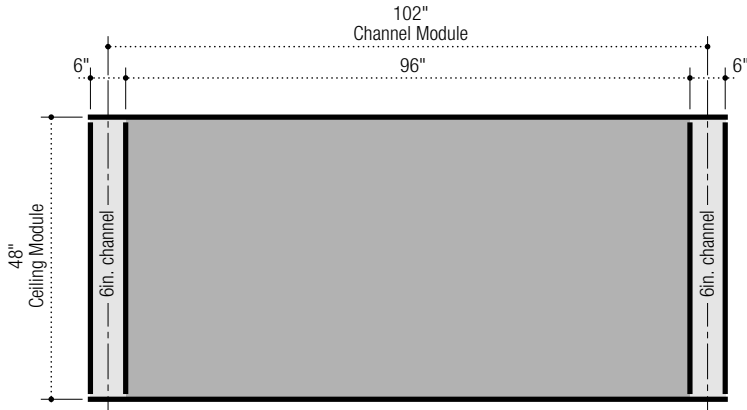

Panel Layout

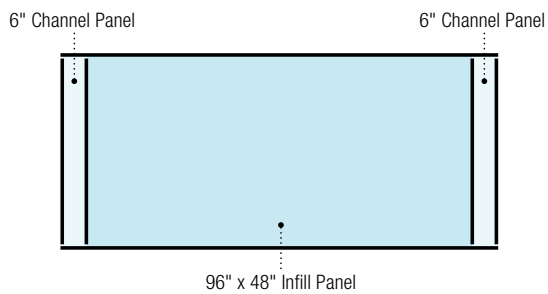

Suspension System Layout

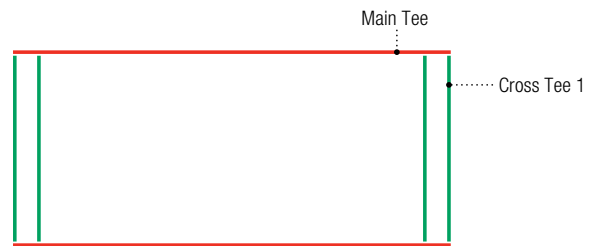

Order Information
System 979

4' Ceiling Module

6" Channel
96" x 48" Infill Panel



Step 1. Select Panels

Step 2. Select Edge for Panels

			FL/FLB		SL/SLT		SQ	
			Edge	Item No.	Edge	Item No.	Edge	Item No.
Infill Panels	HALCYON	96" x 48" x 1"			SL	<input type="checkbox"/> 98483	SQ	<input type="checkbox"/> 98481
Channel Panels	HALCYON	6" x 48" x 1"			SL	<input type="checkbox"/> 99271	SQ	<input type="checkbox"/> 97227
	PANZ Metal Panels, Solid	6" x 48"			SL	<input type="checkbox"/> 256819	SQ	<input type="checkbox"/> 256768
	Panz Metal Panels, Perf C116	6" x 48"			SL	<input type="checkbox"/> 257248	SQ	<input type="checkbox"/> 256397
	Panz Metal Panels, Perf C116D	6" x 48"			SL	<input type="checkbox"/> 257584	SQ	<input type="checkbox"/> 257406

Step 3. Select Corresponding Grid for Selected Panels

			Qty	Item No.	Qty	Item No.	Qty	Item No.
			Suspension Systems	DONN DX	Main Tee			
Cross Tee 1					2	<input type="checkbox"/> DX422	2	<input type="checkbox"/> DX422

Suspension System Estimator

	Length	Sq. Ft.	Main Tee Usage Per Sq. Ft.	Cross Tee 1 Usage Per Sq. Ft.	
System Module	102"	34	0.25	0.24	











Note: Multiply the ceiling area (SF) by the Usage Factor (UF). This calculation will determine lineal footage of suspension system components required. Please refer to the front of this catalogue or IC592 for stabilizer bar usage.

Off-Module Channel Spacing

4' Ceiling Module
System 776

6" Channel
24" x 24" Infill Panel

Selector

Channel Width	Ceiling Module	On-Center Channel Spacing	Infill Panels	Panel Edge	Suspension System
6"	4' (48")	8'-6" (102")	HALCYON 24" x 24" x 1"	FL 	DXT, DXI
				SL 	DX
				SQ 	DX, DXT
			MARS 24" x 24" x 3/4"	FLB 	DXT, DXI
				SLT 	DX
				SQ 	DX, DXT
			MARS High-NRC 24" x 24" x 7/8"	FLB 	DXT, DXI
				SLT 	DX
				SQ 	DX, DXT
			PANZ Metal Panels, Solid 24" x 24"	FL 	DXT, DXI

Module Layout

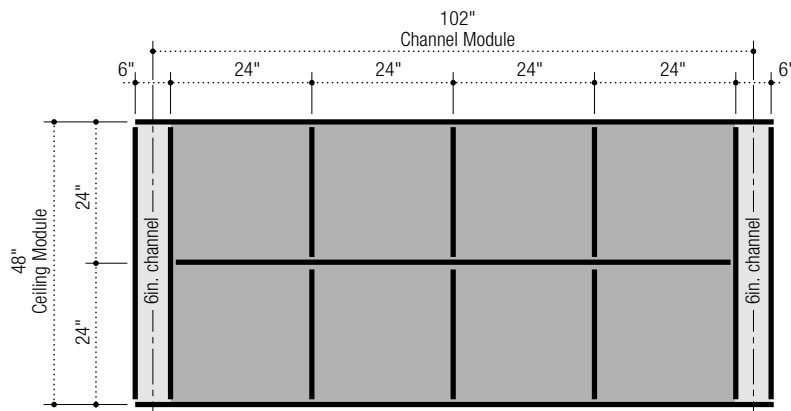

Panel Layout

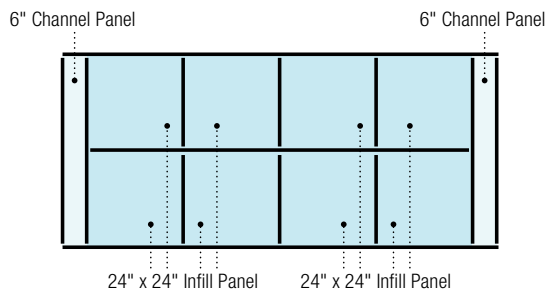

Suspension System Layout

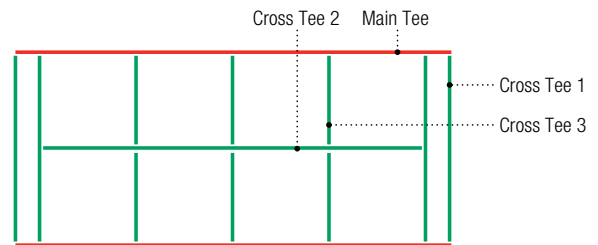

Order Information
System 776

4' Ceiling Module

6" Channel
24" x 24" Infill Panel

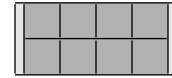

Step 1. Select Panels

Step 2. Select Edge for Panels

			FL/FLB		SL/SLT		SQ	
			Edge	Item No.	Edge	Item No.	Edge	Item No.
Infill Panels	HALCYON	24" x 24" x 1"	FL	<input type="checkbox"/> 98225	SL	<input type="checkbox"/> 98223	SQ	<input type="checkbox"/> 98221
	MARS	24" x 24" x 3/4"	FLB	<input type="checkbox"/> 86985	SLT	<input type="checkbox"/> 86785	SQ	<input type="checkbox"/> 86185
	MARS High-NRC	24" x 24" x 7/8"	FLB	<input type="checkbox"/> 87100	SLT	<input type="checkbox"/> 87200	SQ	<input type="checkbox"/> 86100
	PANZ Metal Panels, Solid	24" x 24"	FL	<input type="checkbox"/> 275616				

Channel Panels	HALCYON	6" x 48" x 1"	FL	<input type="checkbox"/> 98198	SL	<input type="checkbox"/> 99271	SQ	<input type="checkbox"/> 97227
	MARS	6" x 48" x 3/4"	FLB	<input type="checkbox"/> 88887	SLT	<input type="checkbox"/> 86542	SQ	<input type="checkbox"/> 86325
	MARS High-NRC	6" x 48" x 7/8"	FLB	<input type="checkbox"/> 86331	SLT	<input type="checkbox"/> 86442	SQ	<input type="checkbox"/> 86404
	PANZ Metal Panels, Solid	6" x 48"	FL	<input type="checkbox"/> 256820	SL	<input type="checkbox"/> 256819	SQ	<input type="checkbox"/> 256768
	Panz Metal Panels, Perf C116	6" x 48"	FL	<input type="checkbox"/> 256062	SL	<input type="checkbox"/> 257248	SQ	<input type="checkbox"/> 256397
	Panz Metal Panels, Perf C116D	6" x 48"	FL	<input type="checkbox"/> 257585	SL	<input type="checkbox"/> 257584	SQ	<input type="checkbox"/> 257406

Step 3. Select Corresponding Grid for Selected Panels

			Qty	Item No.	Qty	Item No.	Qty	Item No.
Suspension Systems	CENTRICITEE DXT	Main Tee		<input type="checkbox"/> DXT24				<input type="checkbox"/> DXT24
		Cross Tee 1	2	<input type="checkbox"/> DXT424			2	<input type="checkbox"/> DXT424
		Cross Tee 2	3	<input type="checkbox"/> DXT424			3	<input type="checkbox"/> DXT424
		Cross Tee 3	4	<input type="checkbox"/> DXT222			4	<input type="checkbox"/> DXT222
	IDENTITEE DXI	Main Tee		<input type="checkbox"/> DXI24				
		Cross Tee 1	2	<input type="checkbox"/> DXI424				
		Cross Tee 2	3	<input type="checkbox"/> DXI424				
		Cross Tee 3	4	<input type="checkbox"/> DXI222				
	DONN DX	Main Tee			<input type="checkbox"/> DX/DXL24			<input type="checkbox"/> DX/DXL24
		Cross Tee 1			2	<input type="checkbox"/> DX422	2	<input type="checkbox"/> DX422
		Cross Tee 2			3	<input type="checkbox"/> DX422	3	<input type="checkbox"/> DX422
		Cross Tee 3			4	<input type="checkbox"/> DX216	4	<input type="checkbox"/> DX216

Suspension System Estimator

	Length	Sq. Ft.	Main Tee Usage Per Sq. Ft.	Cross Tee 1 Usage Per Sq. Ft.	Cross Tee 2 Usage Per Sq. Ft.	Cross Tee 3 Usage Per Sq. Ft.
System Module	102"	34	0.25	0.24	0.35	0.24

Note: Multiply the ceiling area (SF) by the Usage Factor (UF). This calculation will determine lineal footage of suspension system components required. Please refer to the front of this catalogue or IC592 for stabilizer bar usage.

Off-Module Channel Spacing

4' Ceiling Module

6" Channel

System 383

120" x 24" Infill Panel

Selector

Channel Width	Ceiling Module	On-Center Channel Spacing	Infill Panels	Panel Edge	Suspension System
6"	4' (48")	10'-6" (126")	HALCYON 120" x 24" x 1"	FL	DXT, DXI

Module Layout

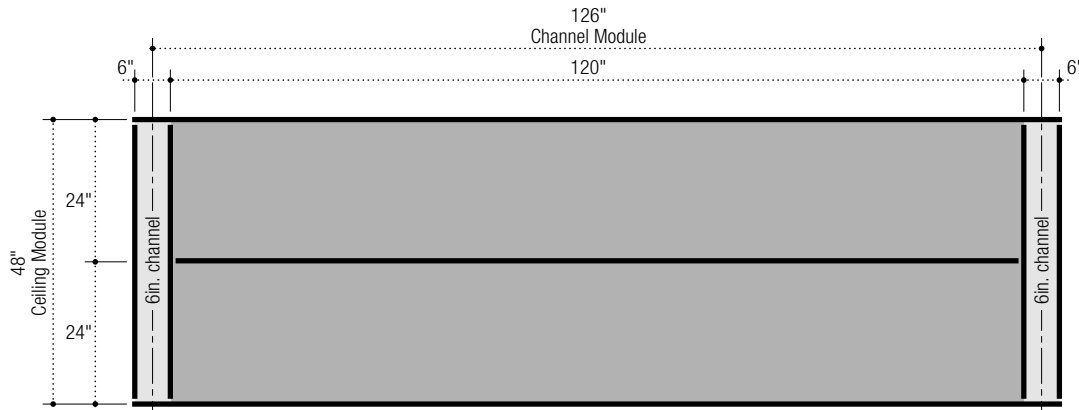

Panel Layout

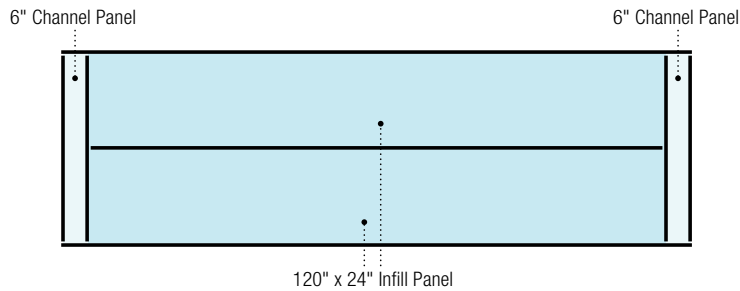

Suspension System Layout

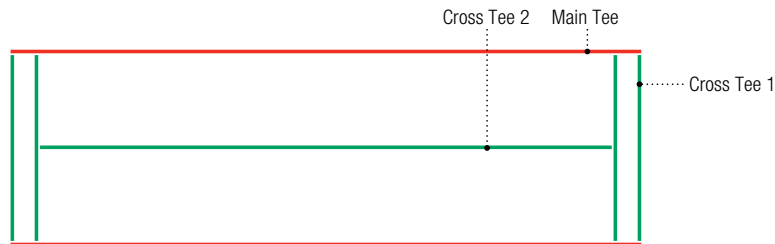

Order Information
System 383

4' Ceiling Module

6" Channel
120" x 24" Infill Panel



Step 1. Select Panels

Step 2. Select Edge for Panels

			FL/FLB		SL/SLT		SQ	
			Edge	Item No.	Edge	Item No.	Edge	Item No.
Infill Panels	HALCYON	120" x 24" x 1"	FL	<input type="checkbox"/> 99213				
Channel Panels	HALCYON	6" x 48" x 1"	FL	<input type="checkbox"/> 98198				
	PANZ Metal Panels, Solid	6" x 48"	FL	<input type="checkbox"/> 256820				
	Panz Metal Panels, Perf C116	6" x 48"	FL	<input type="checkbox"/> 256062				
	Panz Metal Panels, Perf C116D	6" x 48"	FL	<input type="checkbox"/> 257585				

Step 3. Select Corresponding Grid for Selected Panels

			Qty	Item No.	Qty	Item No.	Qty	Item No.
			Suspension Systems	CENTRICITEE DXT	Main Tee		<input type="checkbox"/> DXT24SP110	
Cross Tee 1	2	<input type="checkbox"/> DXT424						
Cross Tee 2	1	<input type="checkbox"/> DXT1024						
IDENTITEE DXI	Main Tee			<input type="checkbox"/> DXI24SP110				
	Cross Tee 1	2		<input type="checkbox"/> DXI424				
	Cross Tee 2	1		<input type="checkbox"/> DXI1024				

Suspension System Estimator

	Length	Sq. Ft.	Main Tee Usage Per Sq. Ft.	Cross Tee 1 Usage Per Sq. Ft.	Cross Tee 2 Usage Per Sq. Ft.	
System Module	126"	34	0.25	0.19	0.24	











Note: Multiply the ceiling area (SF) by the Usage Factor (UF). This calculation will determine lineal footage of suspension system components required. Please refer to the front of this catalogue or IC592 for stabilizer bar usage.

Off-Module Channel Spacing

5' Ceiling Module

4" Channel
30" x 60" Infill Panel

Selector

Channel Width	Ceiling Module	On-Center Channel Spacing	Infill Panels	Panel Edge	Suspension System
4"	5' (60")	5' - 4" (64")	HALCYON 30" x 60" x 1"	FL 	DXT, DXI
				SL 	DX
				SQ 	DX
			MARS 30" x 60" x 3/4"	FLB 	DXT, DXI
				SLT 	DX
				SQ 	DX
			MARS High-NRC 30" x 60" x 7/8"	FLB 	DXT, DXI
				SLT 	DX
				SQ 	DX
			PANZ Metal Panels, Solid 30" x 60"	FL 	DXT, DXI

Module Layout

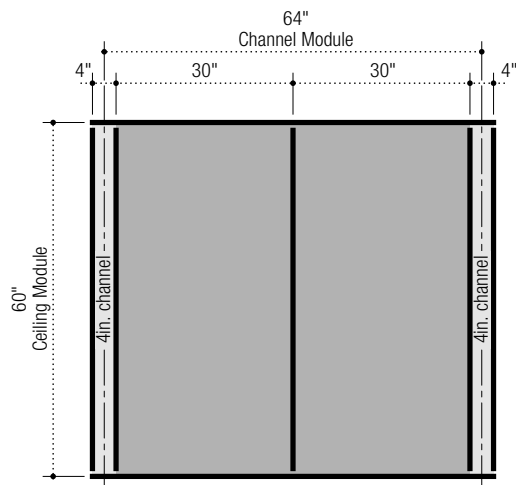

Panel Layout

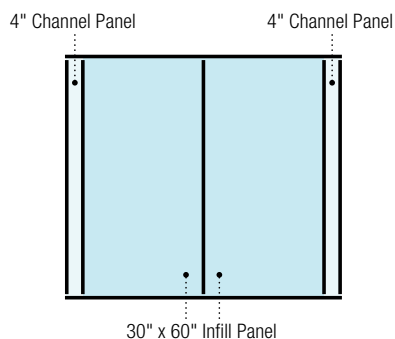

Suspension System Layout

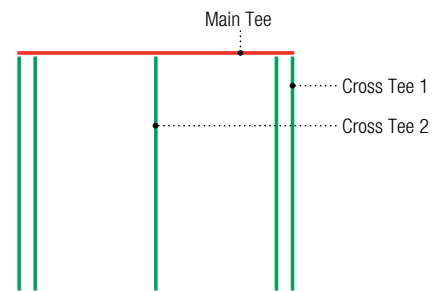

Order Information
System 697

5' Ceiling Module

4" Channel
30" x 60" Infill Panel

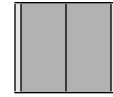

Step 1. Select Panels

Step 2. Select Edge for Panels

			FL/FLB		SL/SLT		SQ	
			Edge	Item No.	Edge	Item No.	Edge	Item No.
Infill Panels	HALCYON	30" x 60" x 1"	FL	<input type="checkbox"/> 98336	SL	<input type="checkbox"/> 99270	SQ	<input type="checkbox"/> 97266
	MARS	30" x 60" x 3/4"	FLB	<input type="checkbox"/> 86267	SLT	<input type="checkbox"/> 86564	SQ	<input type="checkbox"/> 86536
	MARS High-NRC	30" x 60" x 7/8"	FLB	<input type="checkbox"/> 86497	SLT	<input type="checkbox"/> 86466	SQ	<input type="checkbox"/> 86429
	PANZ Metal Panels, Solid	30" x 60"	FL	<input type="checkbox"/> 212201				
Channel Panels	HALCYON	4" x 60" x 1"	FL	<input type="checkbox"/> 97461	SL	<input type="checkbox"/> 97431	SQ	<input type="checkbox"/> 97403
	MARS	4" x 60" x 3/4"	FLB	<input type="checkbox"/> 86569	SLT	<input type="checkbox"/> 86541	SQ	<input type="checkbox"/> 86515
	MARS High-NRC	4" x 60" x 7/8"	FLB	<input type="checkbox"/> 86476	SLT	<input type="checkbox"/> 86441	SQ	<input type="checkbox"/> 86403

Step 3. Select Corresponding Grid for Selected Panels

			Qty	Item No.	Qty	Item No.	Qty	Item No.
Suspension Systems	CENTRICITEE DXT	Main Tee		<input type="checkbox"/> DXT24SP107				
		Cross Tee 1	2	<input type="checkbox"/> DXT524				
		Cross Tee 2	1	<input type="checkbox"/> DXT524				
	IDENTITEE DXI	Main Tee		<input type="checkbox"/> DXI24SP107				
		Cross Tee 1	2	<input type="checkbox"/> DXI524				
		Cross Tee 2	1	<input type="checkbox"/> DXI524				
	DONN DX	Main Tee			<input type="checkbox"/> DX24SP107		<input type="checkbox"/> DX24SP107	
		Cross Tee 1			2	<input type="checkbox"/> DX524	2	<input type="checkbox"/> DX524
		Cross Tee 2			1	<input type="checkbox"/> DX524	1	<input type="checkbox"/> DX524

Suspension System Estimator

	Length	Sq. Ft.	Main Tee Usage Per Sq. Ft.	Cross Tee 1 Usage Per Sq. Ft.	Cross Tee 2 Usage Per Sq. Ft.	
System Module	64"	26.667	0.20	0.38	0.19	

Note: Multiply the ceiling area (SF) by the Usage Factor (UF). This calculation will determine lineal footage of suspension system components required. Please refer to the front of this catalogue or IC592 for stabilizer bar usage.











Off-Module Channel Spacing 5' Ceiling Module

System 369

6" Channel

30" x 60" Infill Panel

Selector

Channel Width	Ceiling Module	On-Center Channel Spacing	Infill Panels	Panel Edge	Suspension System
6"	5' (60")	5' - 6" (66")	HALCYON 30" x 60" x 1"	FL 	DXT, DXI
				SL 	DX
				SQ 	DX
			MARS 30" x 60" x 3/4"	FLB 	DXT, DXI
				SLT 	DX
				SQ 	DX
			MARS High-NRC 30" x 60" x 7/8"	FLB 	DXT, DXI
				SLT 	DX
				SQ 	DX
			PANZ Metal Panels, Solid 30" x 60"	FL 	DXT, DXI

Module Layout

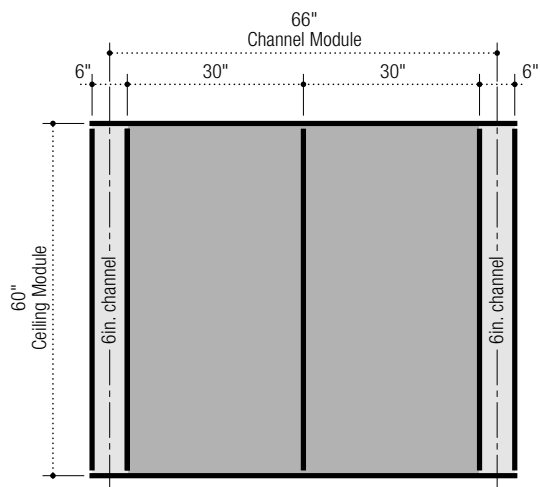

Panel Layout

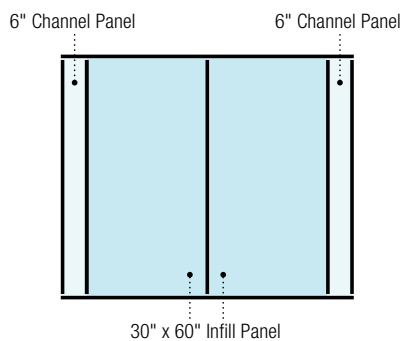

Suspension System Layout

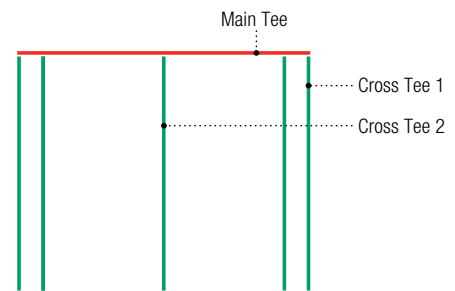

Order Information
System 369

5' Ceiling Module

6" Channel
30" x 60" Infill Panel

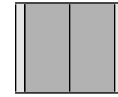

Step 1. Select Panels

Step 2. Select Edge for Panels

			FL/FLB		SL/SLT		SQ	
			Edge	Item No.	Edge	Item No.	Edge	Item No.
Infill Panels	HALCYON	30" x 60" x 1"	FL	<input type="checkbox"/> 98336	SL	<input type="checkbox"/> 99270	SQ	<input type="checkbox"/> 97266
	MARS	30" x 60" x 3/4"	FLB	<input type="checkbox"/> 86267	SLT	<input type="checkbox"/> 86564	SQ	<input type="checkbox"/> 86536
	MARS High-NRC	30" x 60" x 7/8"	FLB	<input type="checkbox"/> 86497	SLT	<input type="checkbox"/> 86466	SQ	<input type="checkbox"/> 86429
	PANZ Metal Panels, Solid	30" x 60"	FL	<input type="checkbox"/> 212201				

Channel Panels	HALCYON	6" x 60" x 1"	FL	<input type="checkbox"/> 98199	SL	<input type="checkbox"/> 99272	SQ	<input type="checkbox"/> 97228
	MARS	6" x 60" x 3/4"	FLB	<input type="checkbox"/> 86835	SLT	<input type="checkbox"/> 86543	SQ	<input type="checkbox"/> 86507
	MARS High-NRC	6" x 60" x 7/8"	FLB	<input type="checkbox"/> 86333	SLT	<input type="checkbox"/> 86443	SQ	<input type="checkbox"/> 86145
	PANZ Metal Panels, Solid	6" x 60"	FL	<input type="checkbox"/> 258036	SL	<input type="checkbox"/> 257972	SQ	<input type="checkbox"/> 257586
	Panz Metal Panels, Perf C116	6" x 60"	FL	<input type="checkbox"/> 259228	SL	<input type="checkbox"/> 259010	SQ	<input type="checkbox"/> 259009
	Panz Metal Panels, Perf C116D	6" x 60"	FL	<input type="checkbox"/> 259353	SL	<input type="checkbox"/> 259344	SQ	<input type="checkbox"/> 259308

Step 3. Select Corresponding Grid for Selected Panels

			Qty	Item No.	Qty	Item No.	Qty	Item No.
Suspension Systems	CENTRICITEE DXT	Main Tee		<input type="checkbox"/> DXT24				
		Cross Tee 1	2	<input type="checkbox"/> DXT524				
		Cross Tee 2	1	<input type="checkbox"/> DXT524				
	IDENTITEE DXI	Main Tee		<input type="checkbox"/> DXI24				
		Cross Tee 1	2	<input type="checkbox"/> DXI524				
		Cross Tee 2	1	<input type="checkbox"/> DXI524				
	DONN DX	Main Tee				<input type="checkbox"/> DX/DXL24		<input type="checkbox"/> DX/DXL24
		Cross Tee 1			2	<input type="checkbox"/> DX524	2	<input type="checkbox"/> DX524
		Cross Tee 2			1	<input type="checkbox"/> DX524	1	<input type="checkbox"/> DX524

Suspension System Estimator

	Length	Sq. Ft.	Main Tee Usage Per Sq. Ft.	Cross Tee 1 Usage Per Sq. Ft.	Cross Tee 2 Usage Per Sq. Ft.	
System Module	66"	27.5	0.20	0.36	0.18	

Note: Multiply the ceiling area (SF) by the Usage Factor (UF). This calculation will determine lineal footage of suspension system components required. Please refer to the front of this catalogue or IC592 for stabilizer bar usage.

Off-Module Channel Spacing











5' Ceiling Module

4" Channel

System 378

30" x 30" Infill Panel

Selector

Channel Width	Ceiling Module	On-Center Channel Spacing	Infill Panels	Panel Edge	Suspension System	
4"	5' (60")	5' - 4" (64")	HALCYON	30" x 30" x 1"	FL 	DXT, DXI
					SL 	DX
					SQ 	DX
			MARS	30" x 30" x 3/4"	FLB 	DXT, DXI
					SLT 	DX
					SQ 	DX
			MARS High-NRC	30" x 30" x 7/8"	FLB 	DXT, DXI
					SLT 	DX
					SQ 	DX
			PANZ Metal Panels, Solid	30" x 30"	FL 	DXT, DXI

Module Layout

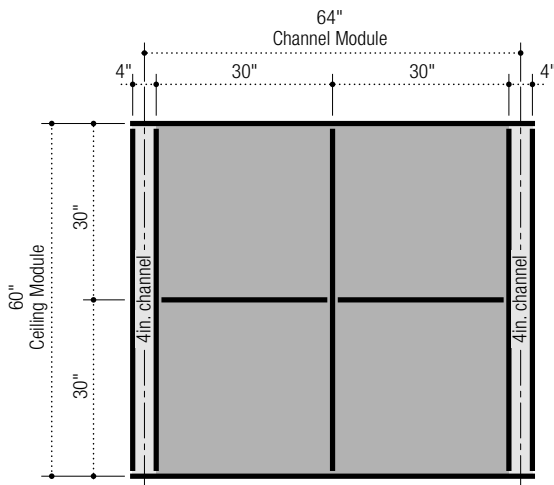

Panel Layout

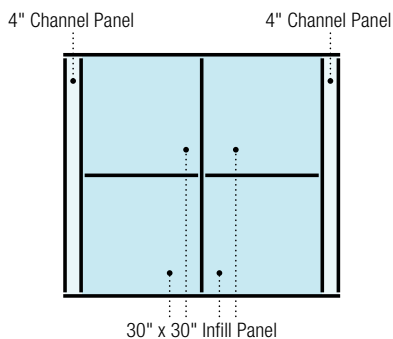

Suspension System Layout

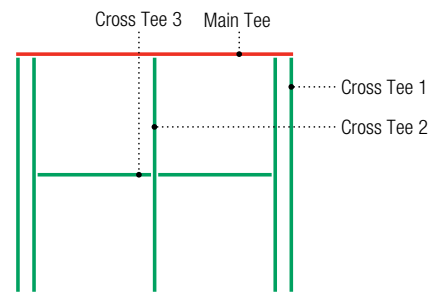

Order Information
System 378

5' Ceiling Module

4" Channel
30" x 30" Infill Panel

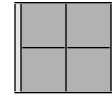

Step 1. Select Panels

Step 2. Select Edge for Panels

			FL/FLB		SL/SLT		SQ	
			Edge	Item No.	Edge	Item No.	Edge	Item No.
Infill Panels	HALCYON	30" x 30" x 1"	FL	<input type="checkbox"/> 98335	SL	<input type="checkbox"/> 98333	SQ	<input type="checkbox"/> 98331
	MARS	30" x 30" x 3/4"	FLB	<input type="checkbox"/> 86830	SLT	<input type="checkbox"/> 86875	SQ	<input type="checkbox"/> 86815
	MARS High-NRC	30" x 30" x 7/8"	FLB	<input type="checkbox"/> 86400	SLT	<input type="checkbox"/> 86500	SQ	<input type="checkbox"/> 86426
	PANZ Metal Panels, Solid	30" x 30"	FL	<input type="checkbox"/> 212123				

Channel Panels	HALCYON	4" x 60" x 1"	FL	<input type="checkbox"/> 97461	SL	<input type="checkbox"/> 97431	SQ	<input type="checkbox"/> 97403
	MARS	4" x 60" x 3/4"	FLB	<input type="checkbox"/> 86569	SLT	<input type="checkbox"/> 86541	SQ	<input type="checkbox"/> 86515
	MARS High-NRC	4" x 60" x 7/8"	FLB	<input type="checkbox"/> 86476	SLT	<input type="checkbox"/> 86441	SQ	<input type="checkbox"/> 86403

Step 3. Select Corresponding Grid for Selected Panels

			Qty	Item No.	Qty	Item No.	Qty	Item No.
Suspension Systems	CENTRICITEE DXT	Main Tee		<input type="checkbox"/> DXT24SP107				
		Cross Tee 1	2	<input type="checkbox"/> DXT524				
		Cross Tee 2	1	<input type="checkbox"/> DXT524				
		Cross Tee 3	1	<input type="checkbox"/> DXT3022				
	IDENTITEE DXI	Main Tee		<input type="checkbox"/> DXI24SP107				
		Cross Tee 1	2	<input type="checkbox"/> DXI524				
		Cross Tee 2	1	<input type="checkbox"/> DXI524				
		Cross Tee 3	1	<input type="checkbox"/> DXI3022				
	DONN DX	Main Tee			<input type="checkbox"/> DX124SP107		<input type="checkbox"/> DX124SP107	
		Cross Tee 1			2 <input type="checkbox"/> DX524	2	<input type="checkbox"/> DX524	
		Cross Tee 2			1 <input type="checkbox"/> DX524	1	<input type="checkbox"/> DX524	
		Cross Tee 3			1 <input type="checkbox"/> DX3016	1	<input type="checkbox"/> DX3016	

Suspension System Estimator

	Length	Sq. Ft.	Main Tee Usage Per Sq. Ft.	Cross Tee 1 Usage Per Sq. Ft.	Cross Tee 2 Usage Per Sq. Ft.	
System Module	66"	27.5	0.20	0.36	0.18	

Note: Multiply the ceiling area (SF) by the Usage Factor (UF). This calculation will determine lineal footage of suspension system components required. Please refer to the front of this catalogue or IC592 for stabilizer bar usage.

Off-Module Channel Spacing











5' Ceiling Module

6" Channel

System 642

30" x 30" Infill Panel

Selector

Channel Width	Ceiling Module	On-Center Channel Spacing	Infill Panels	Panel Edge	Suspension System
6"	5' (60")	5' - 6" (66")	HALCYON 30" x 30" x 1"	FL 	DXT, DXI
				SL 	DX
				SQ 	DX
			MARS 30" x 30" x 3/4"	FLB 	DXT, DXI
				SLT 	DX
				SQ 	DX
			MARS High-NRC 30" x 30" x 7/8"	FLB 	DXT, DXI
				SLT 	DX
				SQ 	DX
			PANZ Metal Panels, Solid 30" x 30"	FL 	DXT, DXI

Module Layout

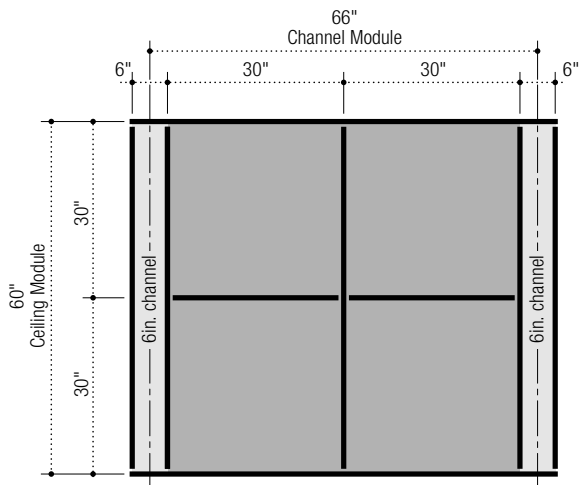

Panel Layout

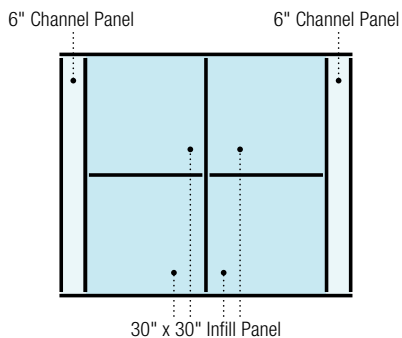

Suspension System Layout

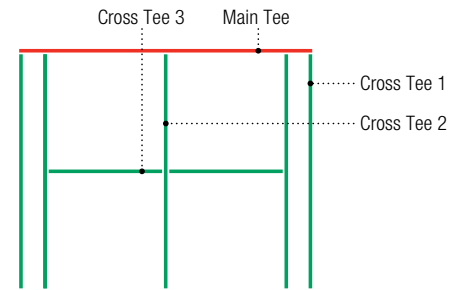

Order Information
System 642

5' Ceiling Module

6" Channel
30" x 30" Infill Panel

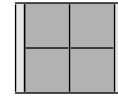

Step 1. Select Panels

Step 2. Select Edge for Panels

			FL/FLB		SL/SLT		SQ	
			Edge	Item No.	Edge	Item No.	Edge	Item No.
Infill Panels	HALCYON	30" x 30" x 1"	FL	<input type="checkbox"/> 98335	SL	<input type="checkbox"/> 98333	SQ	<input type="checkbox"/> 98331
	MARS	30" x 30" x 3/4"	FLB	<input type="checkbox"/> 86830	SLT	<input type="checkbox"/> 86875	SQ	<input type="checkbox"/> 86815
	MARS High-NRC	30" x 30" x 7/8"	FLB	<input type="checkbox"/> 86400	SLT	<input type="checkbox"/> 86500	SQ	<input type="checkbox"/> 86426
	PANZ Metal Panels, Solid	30" x 30"	FL	<input type="checkbox"/> 212123				

Channel Panels	HALCYON	6" x 60" x 1"	FL	<input type="checkbox"/> 98199	SL	<input type="checkbox"/> 99272	SQ	<input type="checkbox"/> 97228
	MARS	6" x 60" x 3/4"	FLB	<input type="checkbox"/> 86835	SLT	<input type="checkbox"/> 86543	SQ	<input type="checkbox"/> 86507
	MARS High-NRC	6" x 60" x 7/8"	FLB	<input type="checkbox"/> 86333	SLT	<input type="checkbox"/> 86443	SQ	<input type="checkbox"/> 86145
	PANZ Metal Panels, Solid	6" x 60"	FL	<input type="checkbox"/> 258036	SL	<input type="checkbox"/> 257972	SQ	<input type="checkbox"/> 257586
	Panz Metal Panels, Perf C116	6" x 60"	FL	<input type="checkbox"/> 259228	SL	<input type="checkbox"/> 259010	SQ	<input type="checkbox"/> 259009
	Panz Metal Panels, Perf C116D	6" x 60"	FL	<input type="checkbox"/> 259353	SL	<input type="checkbox"/> 259344	SQ	<input type="checkbox"/> 259308

Step 3. Select Corresponding Grid for Selected Panels

			Qty	Item No.	Qty	Item No.	Qty	Item No.
Suspension Systems	CENTRICITEE DXT	Main Tee		<input type="checkbox"/> DXT24				
		Cross Tee 1	2	<input type="checkbox"/> DXT524				
		Cross Tee 2	1	<input type="checkbox"/> DXT524				
		Cross Tee 3	2	<input type="checkbox"/> DXT3022				
	IDENTITEE DXI	Main Tee		<input type="checkbox"/> DXI24				
		Cross Tee 1	2	<input type="checkbox"/> DXI524				
		Cross Tee 2	1	<input type="checkbox"/> DXI524				
		Cross Tee 3	2	<input type="checkbox"/> DXI3022				
	DONN DX	Main Tee			<input type="checkbox"/> DX/DXL24		<input type="checkbox"/> DX/DXL24	
		Cross Tee 1			2	<input type="checkbox"/> DX524	2	<input type="checkbox"/> DX524
		Cross Tee 2			1	<input type="checkbox"/> DX524	1	<input type="checkbox"/> DX524
		Cross Tee 3			2	<input type="checkbox"/> DX3016	2	<input type="checkbox"/> DX3016

Suspension System Estimator

	Length	Sq. Ft.	Main Tee Usage Per Sq. Ft.	Cross Tee 1 Usage Per Sq. Ft.	Cross Tee 2 Usage Per Sq. Ft.	Cross Tee 3 Usage Per Sq. Ft.
System Module	66"	27.5	0.20	0.36	0.18	0.18

Note: Multiply the ceiling area (SF) by the Usage Factor (UF). This calculation will determine lineal footage of suspension system components required. Please refer to the front of this catalogue or IC592 for stabilizer bar usage.











Off-Module Channel Spacing 5' Ceiling Module

System 859

4" Channel

24" x 48" Infill Panel

Selector

Channel Width	Ceiling Module	On-Center Channel Spacing	Infill Panels	Panel Edge	Suspension System
4"	6' (72")	4' - 4" (52")	HALCYON 24" x 48" x 1"	FL 	DXT, DXI
				SL 	DX
				SQ 	DX
			MARS 24" x 48" x 3/4"	FLB 	DXT, DXI
				SLT 	DX
				SQ 	DX
			MARS High-NRC 24" x 48" x 7/8"	FLB 	DXT, DXI
				SLT 	DX
				SQ 	DX
			PANZ Metal Panels, Solid 24" x 48"	FL 	DXT, DXI

Module Layout

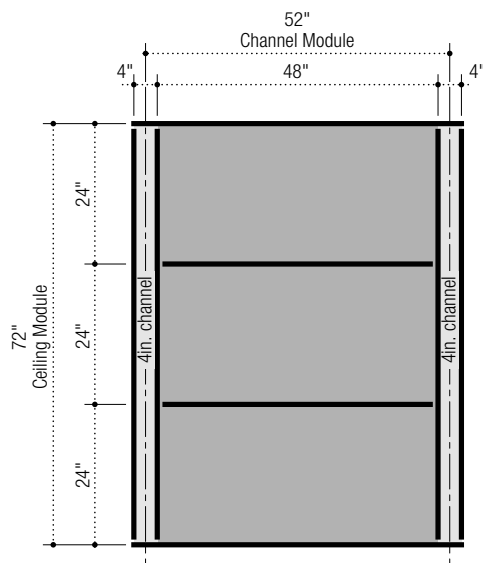

Panel Layout

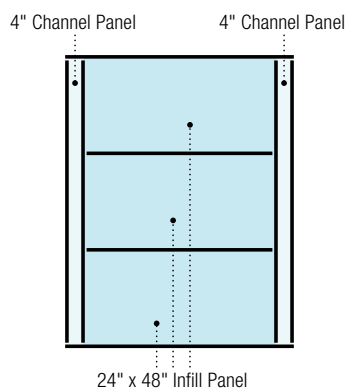

Suspension System Layout

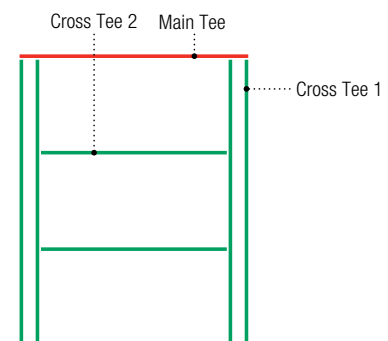

Order Information
System 859

5' Ceiling Module

4" Channel
24" x 48" Infill Panel

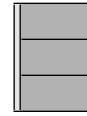

Step 1. Select Panels

Step 2. Select Edge for Panels

			FL/FLB		SL/SLT		SQ	
			Edge	Item No.	Edge	Item No.	Edge	Item No.
Infill Panels	HALCYON	24" x 48" x 1"	FL	<input type="checkbox"/> 98245	SL	<input type="checkbox"/> 98243	SQ	<input type="checkbox"/> 98241
	MARS	24" x 48" x 3/4"	FLB	<input type="checkbox"/> 88985	SLT	<input type="checkbox"/> 88785	SQ	<input type="checkbox"/> 88185
	MARS High-NRC	24" x 48" x 7/8"	FLB	<input type="checkbox"/> 89500	SLT	<input type="checkbox"/> 89600	SQ	<input type="checkbox"/> 86300
	PANZ Metal Panels, Solid	24" x 48"	FL	<input type="checkbox"/> 212164				

Channel Panels	HALCYON	4" x 72" x 1"	FL	<input type="checkbox"/> 97462	SL	<input type="checkbox"/> 97432	SQ	<input type="checkbox"/> 97404
	MARS	4" x 72" x 3/4"	FLB	<input type="checkbox"/> 86584	SLT	<input type="checkbox"/> 86565	SQ	<input type="checkbox"/> 86537
	MARS High-NRC	4" x 72" x 7/8"	FLB	<input type="checkbox"/> 86473	SLT	<input type="checkbox"/> 86467	SQ	<input type="checkbox"/> 86405
	PANZ Metal Panels, Solid	4" x 72"	FL	<input type="checkbox"/> 202652				

Step 3. Select Corresponding Grid for Selected Panels

			Qty	Item No.	Qty	Item No.	Qty	Item No.
Suspension Systems	CENTRICITEE DXT	Main Tee		<input type="checkbox"/> DXT24SP103				
		Cross Tee 1	2	<input type="checkbox"/> DXT424				
		Cross Tee 2	1	<input type="checkbox"/> DXT424				
	IDENTITEE DXI	Main Tee		<input type="checkbox"/> DXI24SP103				
		Cross Tee 1	2	<input type="checkbox"/> DXI424				
		Cross Tee 2	1	<input type="checkbox"/> DXI424				
	DONN DX	Main Tee			<input type="checkbox"/> DX24SP103		<input type="checkbox"/> DX24SP103	
		Cross Tee 1			2	<input type="checkbox"/> DX422	2	<input type="checkbox"/> DX422
		Cross Tee 2			2	<input type="checkbox"/> DX422	2	<input type="checkbox"/> DX422

Suspension System Estimator

	Length	Sq. Ft.	Main Tee Usage Per Sq. Ft.	Cross Tee 1 Usage Per Sq. Ft.	Cross Tee 2 Usage Per Sq. Ft.	
System Module	52"	26	0.17	.46	0.31	

Note: Multiply the ceiling area (SF) by the Usage Factor (UF). This calculation will determine lineal footage of suspension system components required. Please refer to the front of this catalogue or IC592 for stabilizer bar usage.

Off-Module Channel Spacing











6' Ceiling Module

6" Channel

System 824

24" x 48" Infill Panel

Selector

Channel Width	Ceiling Module	On-Center Channel Spacing	Infill Panels	Panel Edge	Suspension System
6"	6' (72")	4' - 6" (54")	HALCYON 24" x 48" x 1"	FL 	DXT, DXI
				SL 	DX
				SQ 	DX
			MARS 24" x 48 x 3/4"	FLB 	DXT, DXI
				SLT 	DX
				SQ 	DX
			MARS High-NRC 24" x 48" x 7/8"	FLB 	DXT, DXI
				SLT 	DX
				SQ 	DX
			PANZ Metal Panels, Solid 24" x 48"	FL 	DXT, DXI

Module Layout

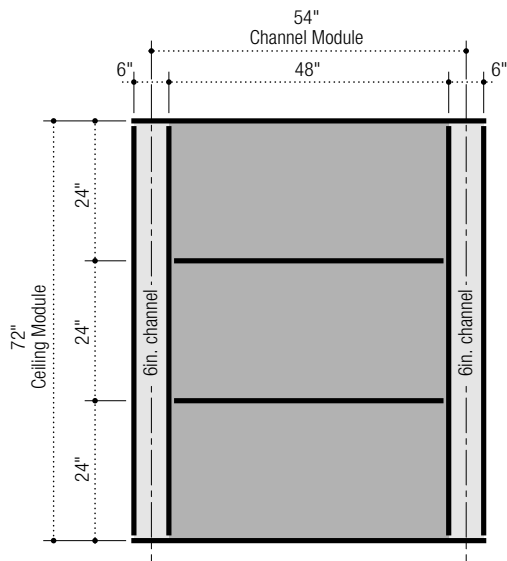

Panel Layout

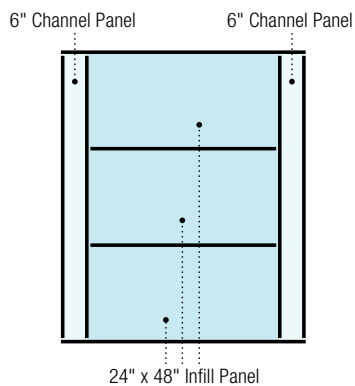

Suspension System Layout

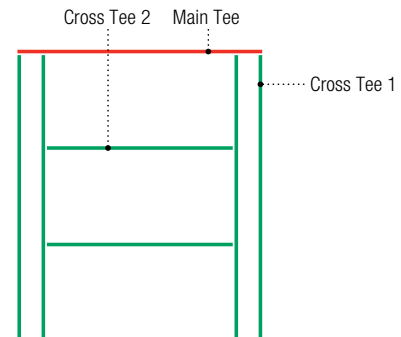

Order Information
System 824

6' Ceiling Module

6" Channel
24" x 48" Infill Panel



Step 1. Select Panels

Step 2. Select Edge for Panels

			FL/FLB		SL/SLT		SQ	
			Edge	Item No.	Edge	Item No.	Edge	Item No.
Infill Panels	HALCYON	24" x 48" x 1"	FL	<input type="checkbox"/> 98245	SL	<input type="checkbox"/> 98243	SQ	<input type="checkbox"/> 98241
	MARS	24" x 48" x 3/4"	FLB	<input type="checkbox"/> 88985	SLT	<input type="checkbox"/> 88785	SQ	<input type="checkbox"/> 88185
	MARS High-NRC	24" x 48" x 7/8"	FLB	<input type="checkbox"/> 89500	SLT	<input type="checkbox"/> 89600	SQ	<input type="checkbox"/> 86300
	PANZ Metal Panels, Solid	24" x 48"	FL	<input type="checkbox"/> 212164				

Channel Panels	HALCYON	6" x 72" x 1"	FL	<input type="checkbox"/> 97574	SL	<input type="checkbox"/> 97433	SQ	<input type="checkbox"/> 97405
	MARS	6" x 72" x 3/4"	FLB	<input type="checkbox"/> 86567	SLT	<input type="checkbox"/> 86566	SQ	<input type="checkbox"/> 86538
	MARS High-NRC	6" x 72" x 7/8"	FLB	<input type="checkbox"/> 86474	SLT	<input type="checkbox"/> 86468	SQ	<input type="checkbox"/> 86406
	PANZ Metal Panels, Solid	6" x 72"	FL	<input type="checkbox"/> 202653				

Step 3. Select Corresponding Grid for Selected Panels

			Qty	Item No.	Qty	Item No.	Qty	Item No.
Suspension Systems	CENTRICITEE DXT	Main Tee		<input type="checkbox"/> DXT24				
		Cross Tee 1	2	<input type="checkbox"/> DXT424				
		Cross Tee 2	2	<input type="checkbox"/> DXT424				
	IDENTITEE DXI	Main Tee		<input type="checkbox"/> DXI24				
		Cross Tee 1	2	<input type="checkbox"/> DXI424				
		Cross Tee 2	2	<input type="checkbox"/> DXI424				
	DONN DX	Main Tee				<input type="checkbox"/> DX/DXL24		<input type="checkbox"/> DX/DXL24
		Cross Tee 1			2	<input type="checkbox"/> DX422	2	<input type="checkbox"/> DX422
		Cross Tee 2			2	<input type="checkbox"/> DX422	2	<input type="checkbox"/> DX422

Suspension System Estimator

	Length	Sq. Ft.	Main Tee Usage Per Sq. Ft.	Cross Tee 1 Usage Per Sq. Ft.	Cross Tee 2 Usage Per Sq. Ft.	
System Module	54"	27	0.17	0.30	0.30	

Note: Multiply the ceiling area (SF) by the Usage Factor (UF). This calculation will determine lineal footage of suspension system components required. Please refer to the front of this catalogue or IC592 for stabilizer bar usage.

Off-Module Channel Spacing











6' Ceiling Module

4" Channel

System 724

24" x 24" Infill Panel

Selector

Channel Width	Ceiling Module	On-Center Channel Spacing	Infill Panels	Panel Edge	Suspension System
4"	6' (72")	4' - 4" (52")	HALCYON 24" x 24" x 1"	FL 	DXT, DXI
				SL 	DX
				SQ 	DX, DXT
			MARS 24" x 24" x 3/4"	FLB 	DXT, DXI
				SLT 	DX
				SQ 	DX, DXT
			MARS High-NRC 24" x 24" x 7/8"	FLB 	DXT, DXI
				SLT 	DX
				SQ 	DX, DXT
			PANZ Metal Panels, Solid 24" x 24"	FL 	DXT, DXI

Module Layout

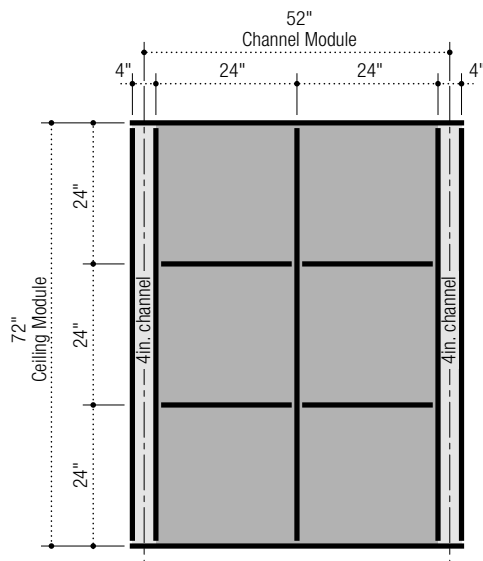

Panel Layout

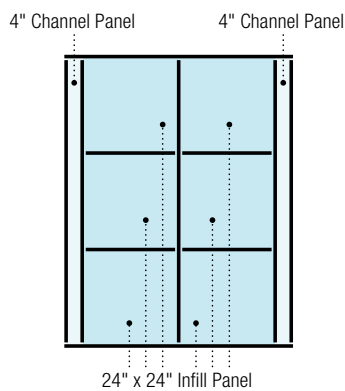

Suspension System Layout

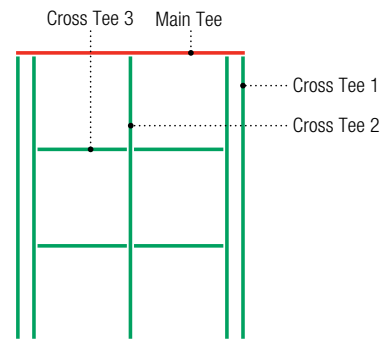

Order Information
System 724

6' Ceiling Module

4" Channel
24" x 24" Infill Panel

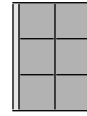

Step 1. Select Panels

Step 2. Select Edge for Panels

			FL/FLB		SL/SLT		SQ	
			Edge	Item No.	Edge	Item No.	Edge	Item No.
Infill Panels	HALCYON	24" x 24" x 1"	FL	<input type="checkbox"/> 98225	SL	<input type="checkbox"/> 98223	SQ	<input type="checkbox"/> 98221
	MARS	24" x 24" x 3/4"	FLB	<input type="checkbox"/> 86985	SLT	<input type="checkbox"/> 86785	SQ	<input type="checkbox"/> 86185
	MARS High-NRC	24" x 24" x 7/8"	FLB	<input type="checkbox"/> 87100	SLT	<input type="checkbox"/> 87200	SQ	<input type="checkbox"/> 86100
	PANZ Metal Panels, Solid	24" x 24"	FL	<input type="checkbox"/> 275616				

Channel Panels	HALCYON	4" x 72" x 1"	FL	<input type="checkbox"/> 97462	SL	<input type="checkbox"/> 97432	SQ	<input type="checkbox"/> 97404
	MARS	4" x 72" x 3/4"	FLB	<input type="checkbox"/> 86584	SLT	<input type="checkbox"/> 86565	SQ	<input type="checkbox"/> 86537
	MARS High-NRC	4" x 72" x 7/8"	FLB	<input type="checkbox"/> 86473	SLT	<input type="checkbox"/> 86467	SQ	<input type="checkbox"/> 86405
	PANZ Metal Panels, Solid	4" x 72"	FL	<input type="checkbox"/> 202652				

Step 3. Select Corresponding Grid for Selected Panels

			Qty	Item No.	Qty	Item No.	Qty	Item No.
Suspension Systems	CENTRICITEE DXT	Main Tee		<input type="checkbox"/> DXT24SP103				<input type="checkbox"/> DXT24SP103
		Cross Tee 1	2	<input type="checkbox"/> DXT624			2	<input type="checkbox"/> DXT624
		Cross Tee 2	1	<input type="checkbox"/> DXT624			1	<input type="checkbox"/> DXT624
		Cross Tee 3	4	<input type="checkbox"/> DXT222			4	<input type="checkbox"/> DXT222
	IDENTITEE DXI	Main Tee		<input type="checkbox"/> DXI24SP103				
		Cross Tee 1	2	<input type="checkbox"/> DXI624				
		Cross Tee 2	1	<input type="checkbox"/> DXI624				
		Cross Tee 3	4	<input type="checkbox"/> DXI222				
	DONN DX	Main Tee				<input type="checkbox"/> DX24SP103		<input type="checkbox"/> DX24SP103
		Cross Tee 1			2	<input type="checkbox"/> DX624	2	<input type="checkbox"/> DX624
		Cross Tee 2			1	<input type="checkbox"/> DX624	1	<input type="checkbox"/> DX624
		Cross Tee 3			4	<input type="checkbox"/> DX216	4	<input type="checkbox"/> DX216

Suspension System Estimator

	Length	Sq. Ft.	Main Tee Usage Per Sq. Ft.	Cross Tee 1 Usage Per Sq. Ft.	Cross Tee 2 Usage Per Sq. Ft.	Cross Tee 3 Usage Per Sq. Ft.
System Module	52"	26	0.17	0.46	0.23	0.31

Note: Multiply the ceiling area (SF) by the Usage Factor (UF). This calculation will determine lineal footage of suspension system components required. Please refer to the front of this catalogue or IC592 for stabilizer bar usage.

Off-Module Channel Spacing











6' Ceiling Module

6" Channel

System 292

24" x 24" Infill Panel

Selector

Channel Width	Ceiling Module	On-Center Channel Spacing	Infill Panels	Panel Edge	Suspension System
6"	6' (72")	4' - 6" (54")	HALCYON 24" x 24" x 1"	FL 	DXT, DXI
				SL 	DX
				SQ 	DX, DXT
			MARS 24" x 24" x 3/4"	FLB 	DXT, DXI
				SLT 	DX
				SQ 	DX, DXT
			MARS High-NRC 24" x 24" x 7/8"	FLB 	DXT, DXI
				SLT 	DX
				SQ 	DX, DXT
			PANZ Metal Panels, Solid 24" x 24"	FL 	DXT, DXI

Module Layout

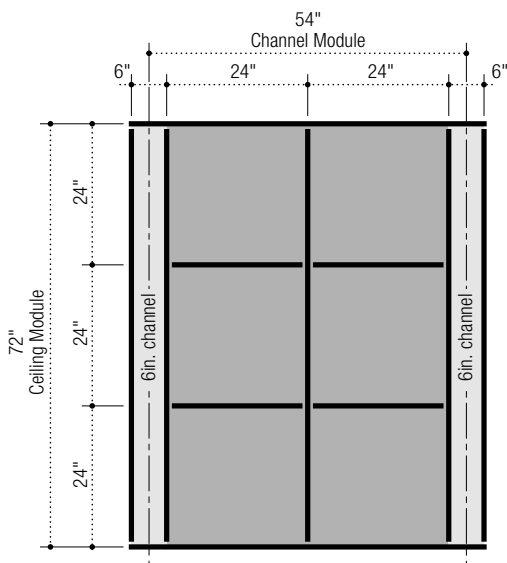

Panel Layout

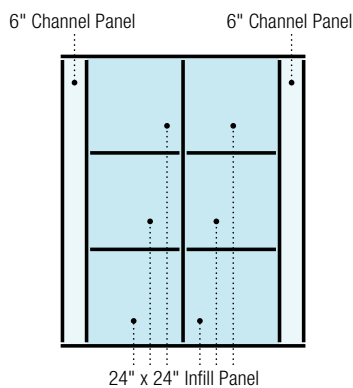

Suspension System Layout

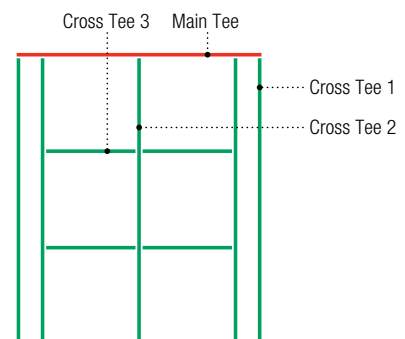

Order Information
System 292

6' Ceiling Module

6" Channel
24" x 24" Infill Panel

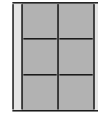

Step 1. Select Panels

Step 2. Select Edge for Panels

			FL/FLB		SL/SLT		SQ	
			Edge	Item No.	Edge	Item No.	Edge	Item No.
Infill Panels	HALCYON	24" x 24" x 1"	FL	<input type="checkbox"/> 98225	SL	<input type="checkbox"/> 98223	SQ	<input type="checkbox"/> 98221
	MARS	24" x 24" x 3/4"	FLB	<input type="checkbox"/> 86985	SLT	<input type="checkbox"/> 86785	SQ	<input type="checkbox"/> 86185
	MARS High-NRC	24" x 24" x 7/8"	FLB	<input type="checkbox"/> 87100	SLT	<input type="checkbox"/> 87200	SQ	<input type="checkbox"/> 86100
	PANZ Metal Panels, Solid	24" x 24"	FL	<input type="checkbox"/> 275616				

Channel Panels	HALCYON	6" x 72" x 1"	FL	<input type="checkbox"/> 97574	SL	<input type="checkbox"/> 97433	SQ	<input type="checkbox"/> 97405
	MARS	6" x 72" x 3/4"	FLB	<input type="checkbox"/> 86567	SLT	<input type="checkbox"/> 86566	SQ	<input type="checkbox"/> 86538
	MARS High-NRC	6" x 72" x 7/8"	FLB	<input type="checkbox"/> 86474	SLT	<input type="checkbox"/> 86468	SQ	<input type="checkbox"/> 86406
	PANZ Metal Panels, Solid	6" x 72"	FL	<input type="checkbox"/> 202653				

Step 3. Select Corresponding Grid for Selected Panels

			Qty	Item No.	Qty	Item No.	Qty	Item No.
Suspension Systems	CENTRICITEE DXT	Main Tee		<input type="checkbox"/> DXT24				<input type="checkbox"/> DXT24
		Cross Tee 1	2	<input type="checkbox"/> DXT624			2	<input type="checkbox"/> DXT624
		Cross Tee 2	1	<input type="checkbox"/> DXT624			1	<input type="checkbox"/> DXT624
		Cross Tee 3	4	<input type="checkbox"/> DXT222			4	<input type="checkbox"/> DXT222
	IDENTITEE DXI	Main Tee		<input type="checkbox"/> DXI24				
		Cross Tee 1	2	<input type="checkbox"/> DXI624				
		Cross Tee 2	1	<input type="checkbox"/> DXI624				
		Cross Tee 3	4	<input type="checkbox"/> DXI222				
	DONN DX	Main Tee				<input type="checkbox"/> DX/DXL24		<input type="checkbox"/> DX/DXL24
		Cross Tee 1			2	<input type="checkbox"/> DX624	2	<input type="checkbox"/> DX624
		Cross Tee 2			1	<input type="checkbox"/> DX624	1	<input type="checkbox"/> DX624
		Cross Tee 3			4	<input type="checkbox"/> DX216	4	<input type="checkbox"/> DX216

Suspension System Estimator

	Length	Sq. Ft.	Main Tee Usage Per Sq. Ft.	Cross Tee 1 Usage Per Sq. Ft.	Cross Tee 2 Usage Per Sq. Ft.	Cross Tee 3 Usage Per Sq. Ft.
System Module	54"	27	0.17	0.44	0.22	0.30

Note: Multiply the ceiling area (SF) by the Usage Factor (UF). This calculation will determine lineal footage of suspension system components required. Please refer to the front of this catalogue or IC592 for stabilizer bar usage.

Off-Module Channel Spacing











6' Ceiling Module

4" Channel

System 562

24" x 72" Infill Panel

Selector

Channel Width	Ceiling Module	On-Center Channel Spacing	Infill Panels	Panel Edge	Suspension System
4"	6' (72")	4' - 4" (52")	HALCYON 24" x 72" x 1"	FL 	DXT, DXI
				SL 	DX
				SQ 	DX
			MARS 24" x 72" x 3/4"	FLB 	DXT, DXI
				SLT 	DX
				SQ 	DX
			MARS High-NRC 24" x 72" x 7/8"	FLB 	DXT, DXI
				SLT 	DX
				SQ 	DX
			PANZ Metal Panels, Solid 24" x 72"	FL 	DXT, DXI

Module Layout

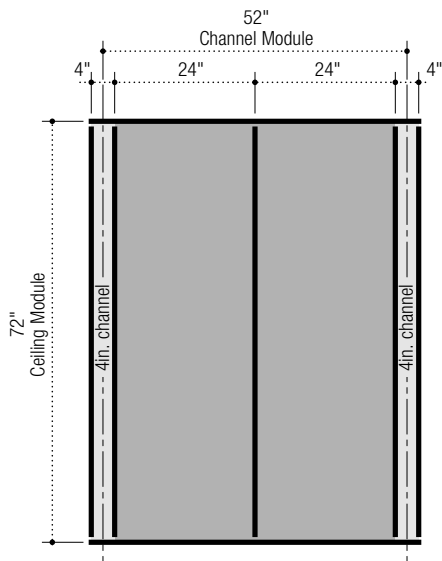

Panel Layout

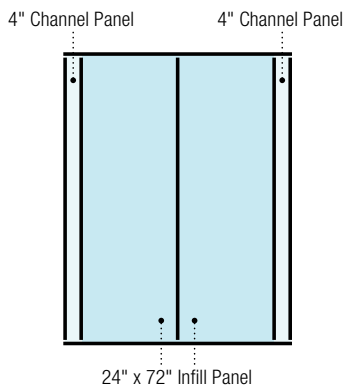

Suspension System Layout

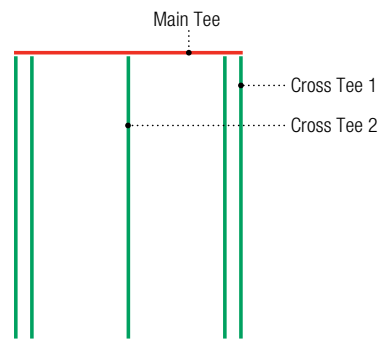

Order Information
System 562

6' Ceiling Module

4" Channel
24" x 72" Infill Panel

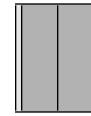

Step 1. Select Panels

Step 2. Select Edge for Panels

			FL/FLB		SL/SLT		SQ	
			Edge	Item No.	Edge	Item No.	Edge	Item No.
Infill Panels	HALCYON	24" x 72" x 1"	FL	<input type="checkbox"/> 98348	SL	<input type="checkbox"/> 99268	SQ	<input type="checkbox"/> 99234
	MARS	24" x 72" x 3/4"	FLB	<input type="checkbox"/> 88996	SLT	<input type="checkbox"/> 86166	SQ	<input type="checkbox"/> 86223
	MARS High-NRC	24" x 72" x 7/8"	FLB	<input type="checkbox"/> 89670	SLT	<input type="checkbox"/> 89660	SQ	<input type="checkbox"/> 86360
	PANZ Metal Panels, Solid	24" x 72"	FL	<input type="checkbox"/> 212192				

Channel Panels	HALCYON	4" x 72" x 1"	FL	<input type="checkbox"/> 97462	SL	<input type="checkbox"/> 97432	SQ	<input type="checkbox"/> 97404
	MARS	4" x 72" x 3/4"	FLB	<input type="checkbox"/> 86584	SLT	<input type="checkbox"/> 86565	SQ	<input type="checkbox"/> 86537
	MARS High-NRC	4" x 72" x 7/8"	FLB	<input type="checkbox"/> 86473	SLT	<input type="checkbox"/> 86467	SQ	<input type="checkbox"/> 86405
	PANZ Metal Panels, Solid	4" x 72"	FL	<input type="checkbox"/> 202652				

Step 3. Select Corresponding Grid for Selected Panels

			Qty	Item No.	Qty	Item No.	Qty	Item No.	
Suspension Systems	CENTRICITEE DXT	Main Tee		<input type="checkbox"/> DXT24SP103					
		Cross Tee 1	2	<input type="checkbox"/> DXT624					
		Cross Tee 2	1	<input type="checkbox"/> DXT624					
	IDENTITEE DXI	Main Tee		<input type="checkbox"/> DXI24SP103					
		Cross Tee 1	2	<input type="checkbox"/> DXI624					
		Cross Tee 2	1	<input type="checkbox"/> DXI624					
	DONN DX	Main Tee				<input type="checkbox"/> DX24SP103		<input type="checkbox"/> DX24SP103	
		Cross Tee 1				2	<input type="checkbox"/> DX624	2	<input type="checkbox"/> DX624
		Cross Tee 2				1	<input type="checkbox"/> DX624	1	<input type="checkbox"/> DX624

Suspension System Estimator

	Length	Sq. Ft.	Main Tee Usage Per Sq. Ft.	Cross Tee 1 Usage Per Sq. Ft.	Cross Tee 2 Usage Per Sq. Ft.	
System Module	52"	26	0.17	0.46	0.23	

Note: Multiply the ceiling area (SF) by the Usage Factor (UF). This calculation will determine lineal footage of suspension system components required. Please refer to the front of this catalogue or IC592 for stabilizer bar usage.

Off-Module Channel Spacing











4' Ceiling Module

6" Channel

System 643

24" x 72" Infill Panel

Selector

Channel Width	Ceiling Module	On-Center Channel Spacing	Infill Panels	Panel Edge	Suspension System
6"	6' (72")	4' - 6" (54")	HALCYON 24" x 72" x 1"	FL 	DXT, DXI
				SL 	DX
				SQ 	DX
			MARS 24" x 72" x 3/4"	FLB 	DXT, DXI
				SLT 	DX
				SQ 	DX
			MARS High-NRC 24" x 72" x 7/8"	FLB 	DXT, DXI
				SLT 	DX
				SQ 	DX
			PANZ Metal Panels, Solid 24" x 72"	FL 	DXT, DXI

Module Layout

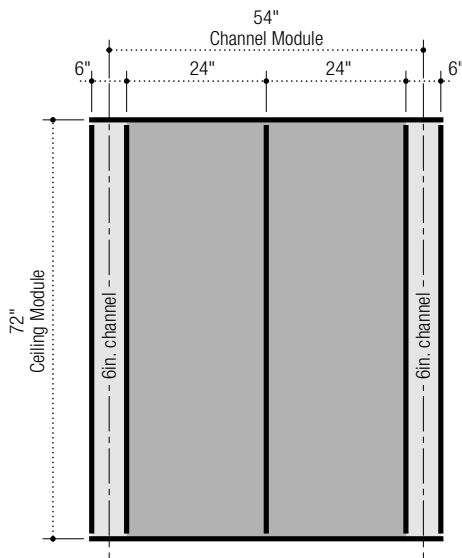

Panel Layout

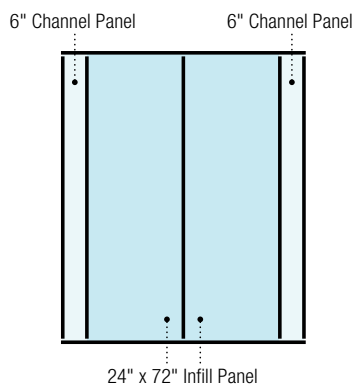

Suspension System Layout

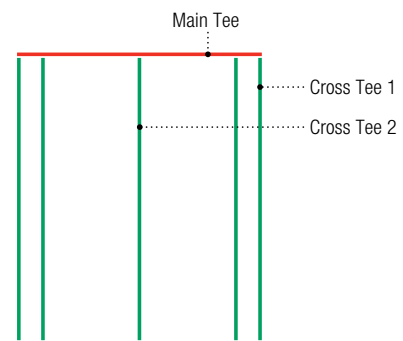

Order Information
System 643

4' Ceiling Module

6" Channel
24" x 72" Infill Panel

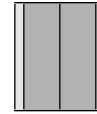

Step 1. Select Panels

Step 2. Select Edge for Panels

			FL/FLB		SL/SLT		SQ	
			Edge	Item No.	Edge	Item No.	Edge	Item No.
Infill Panels	HALCYON	24" x 72" x 1"	FL	<input type="checkbox"/> 98348	SL	<input type="checkbox"/> 99268	SQ	<input type="checkbox"/> 99234
	MARS	24" x 72" x 3/4"	FLB	<input type="checkbox"/> 88996	SLT	<input type="checkbox"/> 86166	SQ	<input type="checkbox"/> 86223
	MARS High-NRC	24" x 72" x 7/8"	FLB	<input type="checkbox"/> 89670	SLT	<input type="checkbox"/> 89660	SQ	<input type="checkbox"/> 86360
	PANZ Metal Panels, Solid	24" x 72"	FL	<input type="checkbox"/> 212192				

Channel Panels	HALCYON	6" x 72" x 1"	FL	<input type="checkbox"/> 97574	SL	<input type="checkbox"/> 97433	SQ	<input type="checkbox"/> 97405
	MARS	6" x 72" x 3/4"	FLB	<input type="checkbox"/> 86567	SLT	<input type="checkbox"/> 86566	SQ	<input type="checkbox"/> 86538
	MARS High-NRC	6" x 72" x 7/8"	FLB	<input type="checkbox"/> 86474	SLT	<input type="checkbox"/> 86468	SQ	<input type="checkbox"/> 86406
	PANZ Metal Panels, Solid	6" x 72"	FL	<input type="checkbox"/> 202653				

Step 3. Select Corresponding Grid for Selected Panels

			Qty	Item No.	Qty	Item No.	Qty	Item No.
Suspension Systems	CENTRICITEE DXT	Main Tee		<input type="checkbox"/> DXT24				
		Cross Tee 1	2	<input type="checkbox"/> DXT624				
		Cross Tee 2	1	<input type="checkbox"/> DXT624				
	IDENTITEE DXI	Main Tee		<input type="checkbox"/> DXI24				
		Cross Tee 1	2	<input type="checkbox"/> DXI624				
		Cross Tee 2	1	<input type="checkbox"/> DXI624				
	DONN DX	Main Tee				<input type="checkbox"/> DX/DXL24		<input type="checkbox"/> DX/DXL24
		Cross Tee 1			2	<input type="checkbox"/> DX624	2	<input type="checkbox"/> DX624
		Cross Tee 2			1	<input type="checkbox"/> DX624	1	<input type="checkbox"/> DX624









Suspension System Estimator

	Length	Sq. Ft.	Main Tee Usage Per Sq. Ft.	Cross Tee 1 Usage Per Sq. Ft.	Cross Tee 2 Usage Per Sq. Ft.	
System Module	54"	27	0.17	0.44	0.22	

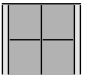
Note: Multiply the ceiling area (SF) by the Usage Factor (UF). This calculation will determine lineal footage of suspension system components required. Please refer to the front of this catalogue or IC592 for stabilizer bar usage.



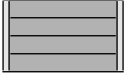

Metric Systems

100mm Channels

	Channel Width	Ceiling Module	On-Center Channel Spacing	Infill Panels	PANZ Metal Option		System	Page
					Infill Panel	Channel Panel		
1000mm Ceiling Module								
	100mm	1000mm	1500mm	1400mm x 500mm	●	●	132	146-147
	100mm	1000mm	1500mm	1400mm x 1000mm		●	116	148-149
1200mm Ceiling Module								
	100mm	1200mm	1200mm	550mm x 600mm	●	●	121	150-151
	100mm	1200mm	1200mm	1100mm x 600mm	●	●	134	152-153
	100mm	1200mm	1200mm	1100mm x 1200mm		●	105	154-155
	100mm	1200mm	1300mm	1200mm x 600mm	●	●	112	156-157
	100mm	1200mm	1300mm	1200mm x 1200mm		●	108	158-159
	100mm	1200mm	1900mm	1800mm x 300mm	●	●	141	160-161
	100mm	1200mm	1900mm	1800mm x 600mm	●	●	139	162-163









Metric Systems

100mm Channels

	Channel Width	Ceiling Module	On-Center Channel Spacing	Infill Panels	PANZ Metal Option		System	Page
					Infill Panel	Channel Panel		
1500mm Ceiling Module								
	100mm	1500mm	1500mm	700mm x 750mm	●	●	124	164-165
	100mm	1500mm	1500mm	1400mm x 750mm	●	●	110	166-167
	100mm	1500mm	1500mm	1400mm x 500mm	●	●	102	168-169
	100mm	1500mm	1500mm	1400mm x 1500mm		●	129	170-171

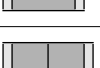
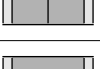
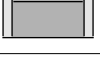

Metric Systems

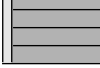
150mm Channels

	Channel Width	Ceiling Module	On-Center Channel Spacing	Infill Panels	PANZ Metal, Solid		System	Page
					Infill Panel	Channel Panel		
1000mm Ceiling Module								
	150mm	1000mm	1500mm	675mm x 500mm	●	●	136	172-173
	150mm	1000mm	1500mm	1350mm x 500mm		●	122	174-175
	150mm	1000mm	1500mm	1350mm x 1000mm		●	107	176-177
1200mm Ceiling Module								
	150mm	1200mm	1200mm	525mm x 600mm		●	113	178-179
	150mm	1200mm	1200mm	1050mm x 600mm		●	109	180-181
	150mm	1200mm	1200mm	1050mm x 1200mm		●	101	182-183
	150mm	1200mm	1350mm	600mm x 600mm	●	●	127	184-185
	150mm	1200mm	1350mm	1200mm x 600mm	●	●	130	186-187
	150mm	1200mm	1350mm	1200mm x 1200mm		●	106	188-189
	150mm	1200mm	1950mm	1800mm x 300mm	●	●	120	190-191
	150mm	1200mm	1950mm	1800mm x 600mm	●	●	137	192-193

Metric Systems

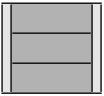
150mm Channels

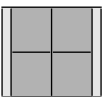
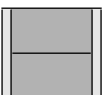
	Channel Width	Ceiling Module	On-Center Channel Spacing	Infill Panels	PANZ Metal, Solid		System	Page
					Infill Panel	Channel Panel		
1500mm Ceiling Module								
	150mm	1500mm	1500mm	1350mm x 500mm	●		114	194-195
	150mm	1500mm	1500mm	1350mm x 1500mm			145	196-197
	150mm	1500mm	1500mm	675mm x 750mm			143	198-199
	150mm	1500mm	1500mm	1350mm x 750mm	●		104	200-201

Metric Systems











System 132

1000mm Ceiling Module

100mm Channel

1400mm x 500mm Infill Panel

Selector

Channel Width	Ceiling Module	On-Center Channel Spacing	Infill Panels	Panel Edge	Suspension System	
100mm	1000mm	1500mm	HALCYON	14000mm x 500mm	FL 	DXT, DXI, DXF
					SL 	DX
					SQ 	DX
			MARS	14000mm x 500mm	FLB 	DXT, DXI, DXF
					SLT 	DX
					SQ 	DX
			MARS High-NRC	14000mm x 500mm	FLB 	DXT, DXI, DXF
					SLT 	DX
					SQ 	DX
			PANZ Metal Panels, Solid	14000mm x 500mm	FL 	DXT, DXI

Module Layout

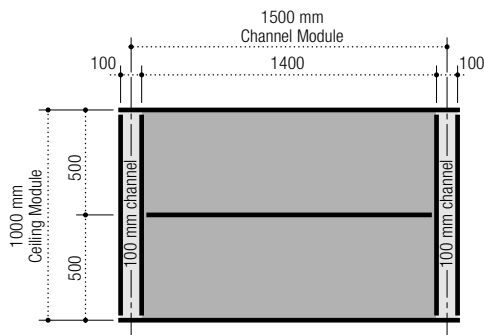

Panel Layout

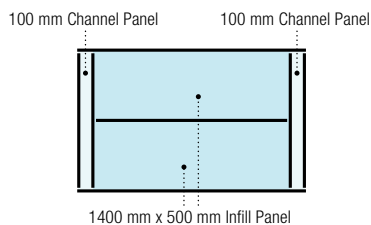

Suspension System Layout

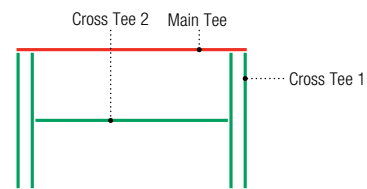



Step 1. Select Panels

Step 2. Select Edge for Panels

			FL/FLB		SL/SLT		SQ	
			Edge	Item No.	Edge	Item No.	Edge	Item No.
Infill Panels	HALCYON	1400mm x 500mm	FL	<input type="checkbox"/> ME97464	SL	<input type="checkbox"/> ME97437	SQ	<input type="checkbox"/> ME97408
	MARS	1400mm x 500mm	FLB	<input type="checkbox"/> ME86571	SLT	<input type="checkbox"/> ME86548	SQ	<input type="checkbox"/> ME86520
	MARS High-NRC	1400mm x 500mm	FLB	<input type="checkbox"/> ME86480	SLT	<input type="checkbox"/> ME86448	SQ	<input type="checkbox"/> ME86411
	PANZ Metal Panels, Solid	1400mm x 500mm	FL	<input type="checkbox"/> ME909964				

Channel Panels	HALCYON	100mm x 1000mm	FL	<input type="checkbox"/> ME97538	SL	<input type="checkbox"/> ME97509	SQ	<input type="checkbox"/> ME97480
	PANZ Metal Panels, Solid	100mm x 1000mm	FL	<input type="checkbox"/> ME99946				

Step 3. Select Corresponding Grid for Selected Panels

			Qty	Item No.	Qty	Item No.	Qty	Item No.
Suspension Systems	CENTRICITEE DXT	Main Tee		<input type="checkbox"/> MEDXT24SP205				
		Cross Tee 1	2	<input type="checkbox"/> MEDXT1000				
		Cross Tee 2	1	<input type="checkbox"/> MEDXT1000				
		Cross Tee 3	2	<input type="checkbox"/> MEDXT700				
	IDENTITEE DXI	Main Tee		<input type="checkbox"/> MEDXI24SP205				
		Cross Tee 1	2	<input type="checkbox"/> MEDXI1000				
		Cross Tee 2	1	<input type="checkbox"/> MEDXI1000				
		Cross Tee 3	2	<input type="checkbox"/> MEDXI700				
	DONN DX	Main Tee			1	<input type="checkbox"/> MEDX24SP205		<input type="checkbox"/> MEDX24SP205
		Cross Tee 1			2	<input type="checkbox"/> MEDX1000	2	<input type="checkbox"/> MEDX1000
		Cross Tee 2			1	<input type="checkbox"/> MEDX1000	1	<input type="checkbox"/> MEDX1000
		Cross Tee 3			2	<input type="checkbox"/> MEDX700	2	<input type="checkbox"/> MEDX700

Suspension System Estimator

	Length	m ²	Main Tee Usage Per m ²	Cross Tee 1 Usage Per m ²	Cross Tee 2 Usage Per m ²	Cross Tee 3 Usage Per m ²
System Module	1500mm	1.500	1.000	1.333	0.667	0.933



Note: Multiply the ceiling area (SF) by the Usage Factor (UF). This calculation will determine lineal footage of suspension system components required. Please refer to the front of this catalogue or IC592 for stabilizer bar usage.

Metric Systems
System 116

1000mm Ceiling Module

100mm Channel
1400mm x 1000mm Infill Panel

Selector

Channel Width	Ceiling Module	On-Center Channel Spacing	Infill Panels	Panel Edge	Suspension System
100mm	1000mm	1500mm	HALCYON 1400mm x 1000mm	FL 	DXT, DXI, DXF
				SL 	DX
				SQ 	DX

Module Layout

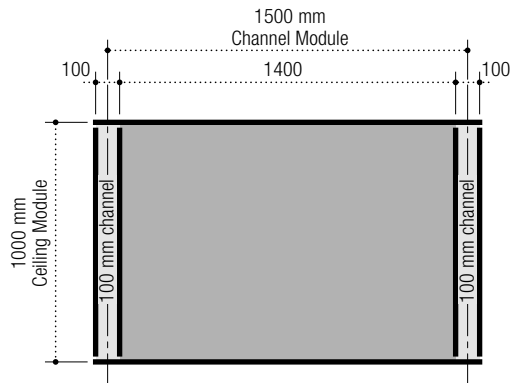

Panel Layout

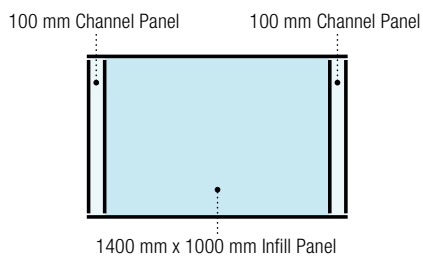

Suspension System Layout

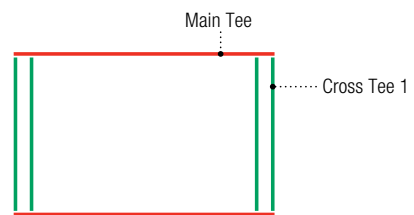

Order Information
System 116

1000mm Ceiling Module

100mm Channel

1400mm x 1000mm Infill Panel



Step 1. Select Panels

Step 2. Select Edge for Panels

			FL/FLB		SL/SLT		SQ	
			Edge	Item No.	Edge	Item No.	Edge	Item No.
Infill Panels	HALCYON	1400mm x 1000mm	FL	<input type="checkbox"/> ME97559	SL	<input type="checkbox"/> ME97530	SQ	<input type="checkbox"/> ME97502

Channel Panels	HALCYON	100mm x 1000mm	FL	<input type="checkbox"/> ME97538	SL	<input type="checkbox"/> ME97509	SQ	<input type="checkbox"/> ME97480
	PANZ Metal Panels, Solid	100mm x 1000mm	FL	<input type="checkbox"/> ME909946				

Step 3. Select Corresponding Grid for Selected Panels

			Qty	Item No.	Qty	Item No.	Qty	Item No.
Suspension Systems	CENTRICITEE DXT	Main Tee		<input type="checkbox"/> MEDXT24SP205				
		Cross Tee 1	2	<input type="checkbox"/> MEDXT1000				
		Cross Tee 2	1	<input type="checkbox"/> MEDXT1400				
	IDENTITEE DXI	Main Tee		<input type="checkbox"/> MEDXI24SP205				
		Cross Tee 1	2	<input type="checkbox"/> MEDXI1000				
		Cross Tee 2	1	<input type="checkbox"/> MEDXI1400				
	DONN DX	Main Tee				<input type="checkbox"/> MEDX24SP205		<input type="checkbox"/> MEDX24SP205
		Cross Tee 1			2	<input type="checkbox"/> MEDX1000	2	<input type="checkbox"/> MEDX1000
		Cross Tee 2			1	<input type="checkbox"/> MEDX1400	1	<input type="checkbox"/> MEDX1400

Suspension System Estimator

	Length	m ²	Main Tee Usage Per m ²	Cross Tee 1 Usage Per m ²	Cross Tee 2 Usage Per m ²	
System Module	1500mm	1.500	1.000	1.333	0.933	









Note: Multiply the ceiling area (SF) by the Usage Factor (UF). This calculation will determine lineal footage of suspension system components required. Please refer to the front of this catalogue or IC592 for stabilizer bar usage.

Metric Systems
System 121

1200mm Ceiling Module

100mm Channel
600mm x 550mm Infill Panel

Selector

Channel Width	Ceiling Module	On-Center Channel Spacing	Infill Panels	Panel Edge	Suspension System	
100mm	1200mm	1200mm	HALCYON	600mm x 550mm	FL 	DXT, DXI, DXF
					SL 	DX
					SQ 	DX, DXT
			MARS	600mm x 550mm	FLB 	DXT, DXI, DXF
					SLT 	DX
					SQ 	DX, DXT
			MARS High-NRC	600mm x 550mm	FLB 	DXT, DXI, DXF
					SLT 	DX
					SQ 	DX, DXT

Module Layout

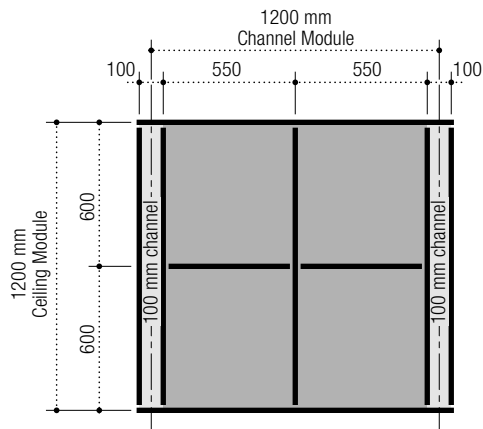

Panel Layout

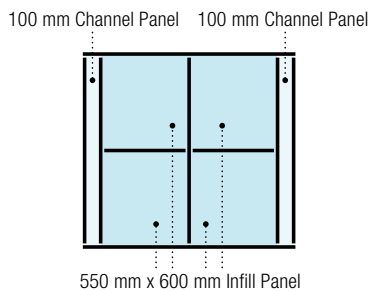

Suspension System Layout

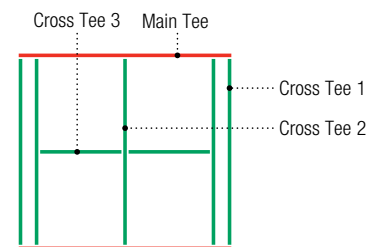

Order Information
System 121

1200mm Ceiling Module

100mm Channel
550mm x 600mm Infill Panel



Step 1. Select Panels

Step 2. Select Edge for Panels

			FL/FLB		SL/SLT		SQ	
			Edge	Item No.	Edge	Item No.	Edge	Item No.
Infill Panels	HALCYON	550mm x 600mm	FL	<input type="checkbox"/> ME97468	SL	<input type="checkbox"/> ME97440	SQ	<input type="checkbox"/> ME97413
	MARS	550mm x 600mm	FLB	<input type="checkbox"/> ME86574	SLT	<input type="checkbox"/> ME86552	SQ	<input type="checkbox"/> ME86524
	MARS High-NRC	550mm x 600mm	FLB	<input type="checkbox"/> ME86485	SLT	<input type="checkbox"/> ME86453	SQ	<input type="checkbox"/> ME86416
	PANZ Metal Panels, Solid	550mm x 600mm	FL	<input type="checkbox"/> ME909965				

Channel Panels	HALCYON	100mm x 1200mm	FL	<input type="checkbox"/> ME97460	SL	<input type="checkbox"/> ME97430	SQ	<input type="checkbox"/> ME97402
	MARS	100mm x 1200mm	FLB	<input type="checkbox"/> ME86568	SLT	<input type="checkbox"/> ME86540	SQ	<input type="checkbox"/> ME86514
	MARS High-NRC	100mm x 1200mm	FLB	<input type="checkbox"/> ME86475	SLT	<input type="checkbox"/> ME86440	SQ	<input type="checkbox"/> ME86402
	PANZ Metal Panels, Solid	100mm x 1200mm	FL	<input type="checkbox"/> ME909947				

Step 3. Select Corresponding Grid for Selected Panels

			Qty	Item No.	Qty	Item No.	Qty	Item No.
Suspension Systems	CENTRICITEE DXT	Main Tee	1	<input type="checkbox"/> MEDXT24SP201			1	<input type="checkbox"/> MEDXT24SP201
		Cross Tee 1	2	<input type="checkbox"/> MEDXT1200			2	<input type="checkbox"/> MEDXT1200
		Cross Tee 2	1	<input type="checkbox"/> MEDXT1200			1	<input type="checkbox"/> MEDXT1200
		Cross Tee 3	2	<input type="checkbox"/> MEDXT550			2	<input type="checkbox"/> MEDXT550
	IDENTITEE DXI	Main Tee	1	<input type="checkbox"/> MEDXI24SP201				
		Cross Tee 1	2	<input type="checkbox"/> MEDXI1200				
		Cross Tee 2	1	<input type="checkbox"/> MEDXI1200				
		Cross Tee 3	2	<input type="checkbox"/> MEDXI550				
	DONN DX	Main Tee			1	<input type="checkbox"/> MEDX24SP201	1	<input type="checkbox"/> MEDX24SP201
		Cross Tee 1			2	<input type="checkbox"/> MEDX1200	2	<input type="checkbox"/> MEDX1200
		Cross Tee 2			1	<input type="checkbox"/> MEDX1200	1	<input type="checkbox"/> MEDX1200
		Cross Tee 3			2	<input type="checkbox"/> MEDX550	2	<input type="checkbox"/> MEDX550

Suspension System Estimator

	Length	m ²	Main Tee Usage Per m ²	Cross Tee 1 Usage Per m ²	Cross Tee 2 Usage Per m ²	Cross Tee 3 Usage Per m ²
System Module	1200mm	1.440	0.833	1.667	0.833	0.764











Note: Multiply the ceiling area (SF) by the Usage Factor (UF). This calculation will determine lineal footage of suspension system components required. Please refer to the front of this catalogue or IC592 for stabilizer bar usage.

Metric Systems
System 134

1200mm Ceiling Module

100mm Channel
1100mm x 600mm Infill Panel

Selector

Channel Width	Ceiling Module	On-Center Channel Spacing	Infill Panels	Panel Edge	Suspension System
100mm	1200mm	1200mm	HALCYON	1100mm x 600mm	FL  DXT, DXI, DXF
					SL  DX
					SQ  DX
			MARS	1100mm x 600mm	FLB  DXT, DXI, DXF
					SLT  DX
					SQ  DX
			MARS High-NRC	1100mm x 600mm	FLB  DXT, DXI, DXF
					SLT  DX
					SQ  DX
			PANZ Metal Panels, Solid	1100mm x 600mm	FL  DXT, DXI

Module Layout

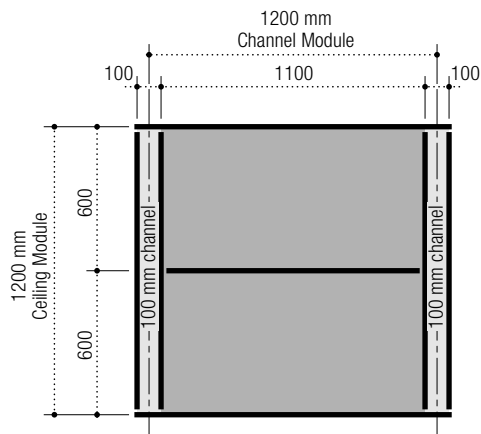

Panel Layout

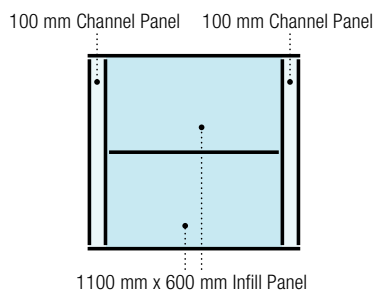

Suspension System Layout

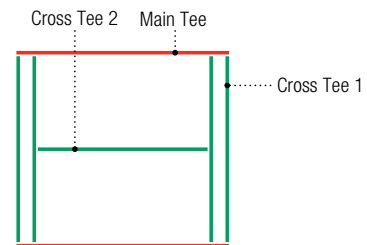

Order Information
System 134

1200mm Ceiling Module

100mm Channel

11000mm x 600mm Infill Panel



Step 1. Select Panels

Step 2. Select Edge for Panels

			FL/FLB		SL/SLT		SQ	
			Edge	Item No.	Edge	Item No.	Edge	Item No.
Infill Panels	HALCYON	1100mm x 600mm	FL	<input type="checkbox"/> ME97470	SL	<input type="checkbox"/> ME97444	SQ	<input type="checkbox"/> ME97416
	MARS	1100mm x 600mm	FLB	<input type="checkbox"/> ME86578	SLT	<input type="checkbox"/> ME86556	SQ	<input type="checkbox"/> ME86528
	MARS High-NRC	1100mm x 600mm	FLB	<input type="checkbox"/> ME86489	SLT	<input type="checkbox"/> ME86457	SQ	<input type="checkbox"/> ME86420
	PANZ Metal Panels, Solid	1100mm x 600mm	FL	<input type="checkbox"/> ME909969				

Channel Panels	HALCYON	100mm x 1200mm	FL	<input type="checkbox"/> ME97460	SL	<input type="checkbox"/> ME97430	SQ	<input type="checkbox"/> ME97402
	MARS	100mm x 1200mm	FLB	<input type="checkbox"/> ME86568	SLT	<input type="checkbox"/> ME86540	SQ	<input type="checkbox"/> ME86514
	MARS High-NRC	100mm x 1200mm	FLB	<input type="checkbox"/> ME86475	SLT	<input type="checkbox"/> ME86440	SQ	<input type="checkbox"/> ME86402
	PANZ Metal Panels, Solid	100mm x 1200mm	FL	<input type="checkbox"/> ME909947				

Step 3. Select Corresponding Grid for Selected Panels

			Qty	Item No.	Qty	Item No.	Qty	Item No.
Suspension Systems	CENTRICITEE DXT	Main Tee		<input type="checkbox"/> MEDXT24SP201				
		Cross Tee 1	2	<input type="checkbox"/> MEDXT1200				
		Cross Tee 2	1	<input type="checkbox"/> MEDXT1100				
	IDENTITEE DXI	Main Tee		<input type="checkbox"/> MEDXI24SP201				
		Cross Tee 1	2	<input type="checkbox"/> MEDXI1200				
		Cross Tee 2	1	<input type="checkbox"/> MEDXI1100				
	DONN DX	Main Tee			<input type="checkbox"/> MEDX24SP201		<input type="checkbox"/> MEDX24SP201	
		Cross Tee 1			2	<input type="checkbox"/> MEDX1200	2	<input type="checkbox"/> MEDX1200
		Cross Tee 2			1	<input type="checkbox"/> MEDX1100	1	<input type="checkbox"/> MEDX1100

Suspension System Estimator

	Length	m ²	Main Tee Usage Per m ²	Cross Tee 1 Usage Per m ²	Cross Tee 2 Usage Per m ²	
System Module	1200mm	1.440	0.833	1.667	0.764	



Note: Multiply the ceiling area (SF) by the Usage Factor (UF). This calculation will determine lineal footage of suspension system components required. Please refer to the front of this catalogue or IC592 for stabilizer bar usage.

Metric Systems
System 105

1200mm Ceiling Module

100mm Channel
1100mm x 1200mm Infill Panel

Selector

Channel Width	Ceiling Module	On-Center Channel Spacing	Infill Panels	Panel Edge	Suspension System
110mm	1200mm	1200mm	HALCYON	1100mm x 1200mm	FL  DXT, DXI, DXF
					SL  DX
					SQ  DX

Module Layout

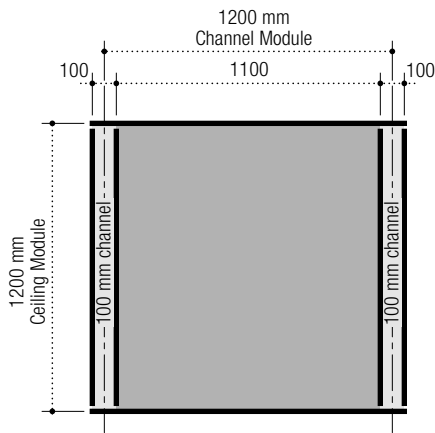

Panel Layout

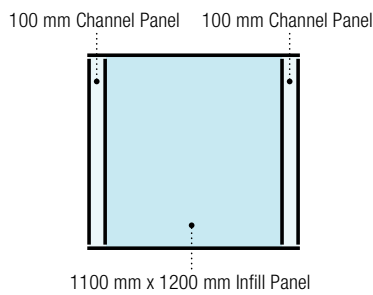

Suspension System Layout

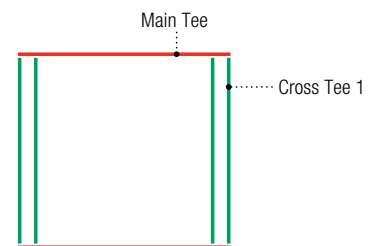

Order Information
System 105

1200mm Ceiling Module

100mm Channel

1100mm x 1200mm Infill Panel



Step 1. Select Panels

Step 2. Select Edge for Panels

			FL/FLB		SL/SLT		SQ	
			Edge	Item No.	Edge	Item No.	Edge	Item No.
Infill Panels	HALCYON	1100mm x 1200mm	FL	<input type="checkbox"/> ME97562	SL	<input type="checkbox"/> ME97533	SQ	<input type="checkbox"/> ME97505

Channel Panels	HALCYON	100mm x 1200mm	FL	<input type="checkbox"/> ME97460	SL	<input type="checkbox"/> ME97430	SQ	<input type="checkbox"/> ME97402
	PANZ Metal Panels, Solid	100mm x 1200mm	FL	<input type="checkbox"/> ME909947				

Step 3. Select Corresponding Grid for Selected Panels











			Qty	Item No.	Qty	Item No.	Qty	Item No.
Suspension Systems	CENTRICITEE DXT	Main Tee		<input type="checkbox"/> MEDXT24SP201				
		Cross Tee 1	2	<input type="checkbox"/> MEDXT1200				
	IDENTITEE DXI	Main Tee		<input type="checkbox"/> MEDXI24SP201				
		Cross Tee 1	2	<input type="checkbox"/> MEDXI1200				
	DONN DX	Main Tee			<input type="checkbox"/> MEDX24SP201		<input type="checkbox"/> MEDX24SP201	
		Cross Tee 1			2	<input type="checkbox"/> MEDX1200	2	<input type="checkbox"/> MEDX1200

Suspension System Estimator

	Length	m ²	Main Tee Usage Per m ²	Cross Tee 1 Usage Per m ²	
System Module	1200mm	1.440	0.833	1.667	

Note: Multiply the ceiling area (SF) by the Usage Factor (UF). This calculation will determine lineal footage of suspension system components required. Please refer to the front of this catalogue or IC592 for stabilizer bar usage.

Selector

Channel Width	Ceiling Module	On-Center Channel Spacing	Infill Panels	Panel Edge	Suspension System
100mm	1200mm	1300mm	HALCYON	1200mm x 600mm	FL  DXT, DXI, DXF
					SL  DX
					SQ  DX
			MARS	1200mm x 600mm	FLB  DXT, DXI, DXF
					SLT  DX
					SQ  DX
			MARS High-NRC	1200mm x 600mm	FLB  DXT, DXI, DXF
					SLT  DX
					SQ  DX
			PANZ Metal Panels, Solid	1200mm x 600mm	FL  DXT, DXI

Module Layout

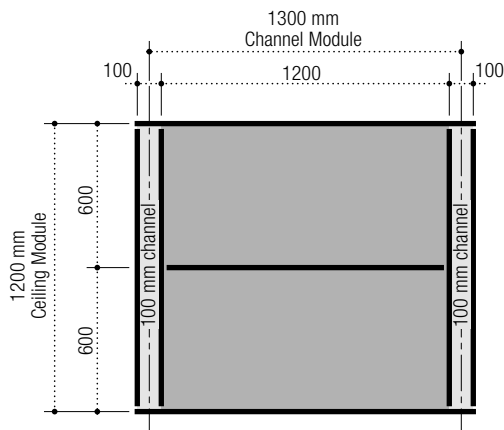

Panel Layout

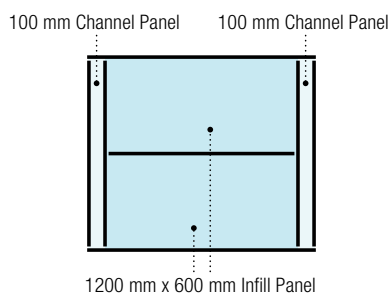

Suspension System Layout

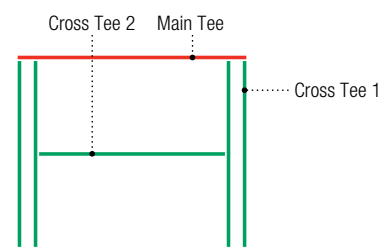

Order Information
System 112

1200mm Ceiling Module

100mm Channel

1200mm x 600mm Infill Panel



Step 1. Select Panels

Step 2. Select Edge for Panels

			FL/FLB		SL/SLT		SQ	
			Edge	Item No.	Edge	Item No.	Edge	Item No.
Infill Panels	HALCYON	1200mm x 600mm	FL	<input type="checkbox"/> ME98245	SL	<input type="checkbox"/> ME98243	SQ	<input type="checkbox"/> ME98241
	MARS	1200mm x 600mm	FLB	<input type="checkbox"/> ME88985	SLT	<input type="checkbox"/> ME88785	SQ	<input type="checkbox"/> ME88185
	MARS High-NRC	1200mm x 600mm	FLB	<input type="checkbox"/> ME89500	SLT	<input type="checkbox"/> ME89600	SQ	<input type="checkbox"/> ME86300
	PANZ Metal Panels, Solid	1200mm x 600mm	FL	<input type="checkbox"/> ME909974				

Channel Panels	HALCYON	100mm x 1200mm	FL	<input type="checkbox"/> ME97460	SL	<input type="checkbox"/> ME97430	SQ	<input type="checkbox"/> ME97402
	MARS	100mm x 1200mm	FLB	<input type="checkbox"/> ME86568	SLT	<input type="checkbox"/> ME86540	SQ	<input type="checkbox"/> ME86514
	MARS High-NRC	100mm x 1200mm	FLB	<input type="checkbox"/> ME86475	SLT	<input type="checkbox"/> ME86440	SQ	<input type="checkbox"/> ME86402
	PANZ Metal Panels, Solid	100mm x 1200mm	FL	<input type="checkbox"/> ME909947				

Step 3. Select Corresponding Grid for Selected Panels

			Qty	Item No.	Qty	Item No.	Qty	Item No.
Suspension Systems	CENTRICITEE DXT	Main Tee		<input type="checkbox"/> MEDXT24SP203				
		Cross Tee 1	2	<input type="checkbox"/> MEDXT1200				
		Cross Tee 2	1	<input type="checkbox"/> MEDXT1200				
	IDENTITEE DXI	Main Tee		<input type="checkbox"/> MEDXI24SP203				
		Cross Tee 1	2	<input type="checkbox"/> MEDXI1200				
		Cross Tee 2	1	<input type="checkbox"/> MEDXI1200				
	DONN DX	Main Tee			<input type="checkbox"/> MEDX24SP203		<input type="checkbox"/> MEDX24SP203	
		Cross Tee 1			2	<input type="checkbox"/> MEDX1200	2	<input type="checkbox"/> MEDX1200
		Cross Tee 2			1	<input type="checkbox"/> MEDX1200	1	<input type="checkbox"/> MEDX1200

Suspension System Estimator

	Length	m ²	Main Tee Usage Per m ²	Cross Tee 1 Usage Per m ²	Cross Tee 2 Usage Per m ²	
System Module	1300mm	1.560	0.833	1.538	0.769	



Note: Multiply the ceiling area (SF) by the Usage Factor (UF). This calculation will determine lineal footage of suspension system components required. Please refer to the front of this catalogue or IC592 for stabilizer bar usage.

Metric Systems
System 108

1200mm Ceiling Module

100mm Channel
1200mm x 1200mm Infill Panel

Selector

Channel Width	Ceiling Module	On-Center Channel Spacing	Infill Panels	Panel Edge	Suspension System
100mm	1200mm	1300mm	HALCYON	1200mm x 1200mm	FL  DXT, DXI, DXF
					SL  DX
					SQ  DX

Module Layout

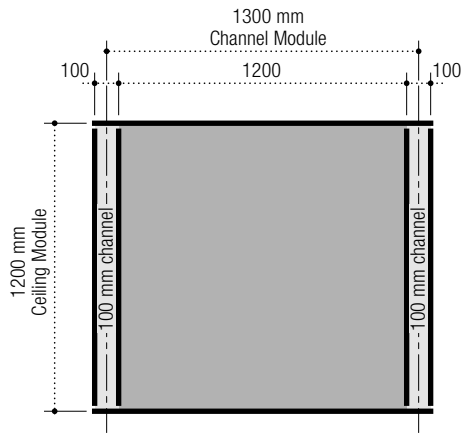

Panel Layout

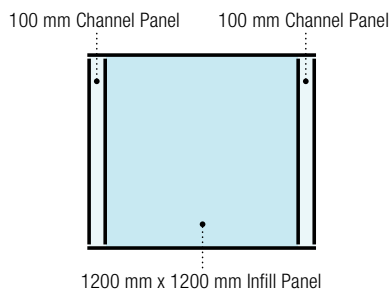

Suspension System Layout

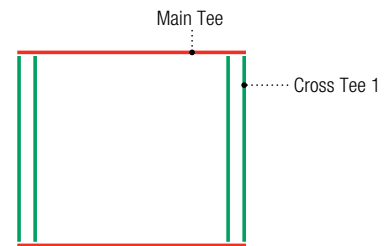

Order Information
System 108

1200mm Ceiling Module

100mm Channel

1200mm x 1200mm Infill Panel



Step 1. Select Panels

Step 2. Select Edge for Panels

			FL/FLB		SL/SLT		SQ	
			Edge	Item No.	Edge	Item No.	Edge	Item No.
Infill Panels	HALCYON	1200mm x 1200mm	FL	<input type="checkbox"/> ME98445	SL	<input type="checkbox"/> ME98443	SQ	<input type="checkbox"/> ME98441

Channel Panels	HALCYON	100mm x 1200mm	FL	<input type="checkbox"/> ME97460	SL	<input type="checkbox"/> ME97430	SQ	<input type="checkbox"/> ME97402
	PANZ Metal Panels, Solid	100mm x 1200mm	FL	<input type="checkbox"/> ME909947				

Step 3. Select Corresponding Grid for Selected Panels

			Qty	Item No.	Qty	Item No.	Qty	Item No.
Suspension Systems	CENTRICITEE DXT	Main Tee		<input type="checkbox"/> MEDXT24SP203				
		Cross Tee 1	2	<input type="checkbox"/> MEDXT1200				
	IDENTITEE DXI	Main Tee		<input type="checkbox"/> MEDXI24SP203				
		Cross Tee 1	2	<input type="checkbox"/> MEDXI1200				
	DONN DX	Main Tee			<input type="checkbox"/> MEDX24SP203		<input type="checkbox"/> MEDX24SP203	
		Cross Tee 1			2	<input type="checkbox"/> MEDX1200	2	<input type="checkbox"/> MEDX1200

Suspension System Estimator

	Length	m ²	Main Tee Usage Per m ²	Cross Tee 1 Usage Per m ²	
System Module	1300mm	1.560	0.833	1.538	

Note: Multiply the ceiling area (SF) by the Usage Factor (UF). This calculation will determine lineal footage of suspension system components required. Please refer to the front of this catalogue or IC592 for stabilizer bar usage.

Metric Systems











System 141

1200mm Ceiling Module

100mm Channel

1800mm x 300mm Infill Panel

Selector

Channel Width	Ceiling Module	On-Center Channel Spacing	Infill Panels	Panel Edge	Suspension System	
100mm	1200mm	1900mm	HALCYON	1800mm x 300mm	FL 	DXT, DXI, DXF
					SL 	DX
					SQ 	DX
			MARS	1800mm x 300mm	FLB 	DXT, DXI, DXF
					SLT 	DX
					SQ 	DX
			MARS High-NRC	1800mm x 300mm	FLB 	DXT, DXI, DXF
					SLT 	DX
					SQ 	DX
			PANZ Metal Panels, Solid	1800mm x 300mm	FL 	DXT, DXI

Module Layout

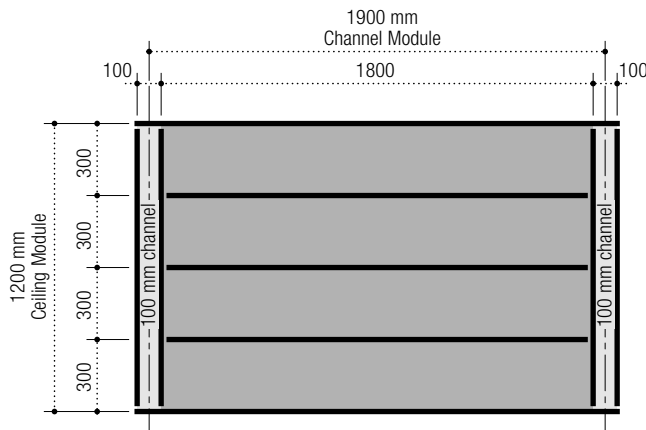

Panel Layout

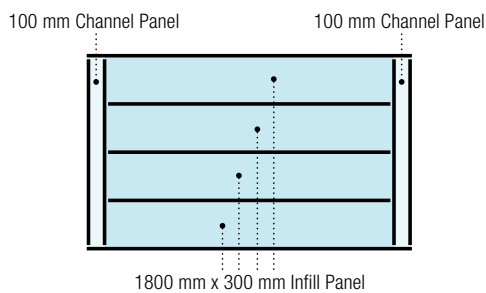

Suspension System Layout

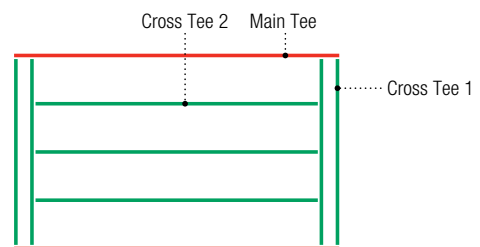

Order Information
System 141

1200mm Ceiling Module

100mm Channel

1800mm x 300mm Infill Panel

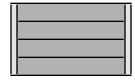

Step 1. Select Panels

Step 2. Select Edge for Panels

			FL/FLB		SL/SLT		SQ	
			Edge	Item No.	Edge	Item No.	Edge	Item No.
Infill Panels	HALCYON	300mm x 1800mm	FL	<input type="checkbox"/> ME97574	SL	<input type="checkbox"/> ME97433	SQ	<input type="checkbox"/> ME97405
	MARS	300mm x 1800mm	FLB	<input type="checkbox"/> ME86570	SLT	<input type="checkbox"/> ME86546	SQ	<input type="checkbox"/> ME86518
	MARS High-NRC	300mm x 1800mm	FLB	<input type="checkbox"/> ME86478	SLT	<input type="checkbox"/> ME86446	SQ	<input type="checkbox"/> ME86409
	PANZ Metal Panels, Solid	300mm x 1800mm	FL	<input type="checkbox"/> ME909956				

Channel Panels	HALCYON	100mm x 1200mm	FL	<input type="checkbox"/> ME97460	SL	<input type="checkbox"/> ME97430	SQ	<input type="checkbox"/> ME97402
	MARS	100mm x 1200mm	FLB	<input type="checkbox"/> ME86568	SLT	<input type="checkbox"/> ME86540	SQ	<input type="checkbox"/> ME86514
	MARS High-NRC	100mm x 1200mm	FLB	<input type="checkbox"/> ME86475	SLT	<input type="checkbox"/> ME86440	SQ	<input type="checkbox"/> ME86402
	PANZ Metal Panels, Solid	100mm x 1200mm	FL	<input type="checkbox"/> ME909947				

Step 3. Select Corresponding Grid for Selected Panels

			Qty	Item No.	Qty	Item No.	Qty	Item No.
Suspension Systems	CENTRICITEE DXT (Use with PANZ)	Main Tee		<input type="checkbox"/> MEDXT24SP203				
		Cross Tee 1	2	<input type="checkbox"/> MEDXT1200				
		Cross Tee 2	3	<input type="checkbox"/> MEDXT1900				
	IDENTITEE DXI	Main Tee		<input type="checkbox"/> MEDXI24SP203				
		Cross Tee 1	2	<input type="checkbox"/> MEDXI1200				
		Cross Tee 2	3	<input type="checkbox"/> MEDXI1900				
	DONN DX	Main Tee			<input type="checkbox"/> MEDX24SP203		<input type="checkbox"/> MEDX24SP203	
		Cross Tee 1			2	<input type="checkbox"/> MEDX1200	2	<input type="checkbox"/> MEDX1200
		Cross Tee 2			3	<input type="checkbox"/> MEDX1900	3	<input type="checkbox"/> MEDX1900

Suspension System Estimator

	Length	m ²	Main Tee Usage Per m ²	Cross Tee 1 Usage Per m ²	Cross Tee 2 Usage Per m ²	
System Module	1900mm	2.280	0.833	1.053	2.500	









Note: Multiply the ceiling area (SF) by the Usage Factor (UF). This calculation will determine lineal footage of suspension system components required. Please refer to the front of this catalogue or IC592 for stabilizer bar usage.

Metric Systems
System 139

1200mm Ceiling Module

100mm Channel
1800mm x 600mm Infill Panel

Selector

Channel Width	Ceiling Module	On-Center Channel Spacing	Infill Panels	Panel Edge	Suspension System	
100mm	1200mm	1900mm	HALCYON	1800mm x 600mm	FL 	DXT, DXI, DXF
					SL 	DX
					SQ 	DX
			MARS	1800mm x 600mm	FLB 	DXT, DXI, DXF
					SLT 	DX
					SQ 	DX
			MARS High-NRC	1800mm x 600mm	FLB 	DXT, DXI, DXF
					SLT 	DX
					SQ 	DX

Module Layout

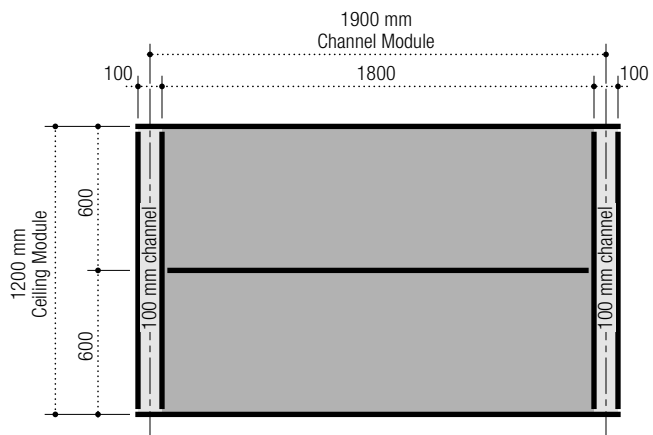

Panel Layout

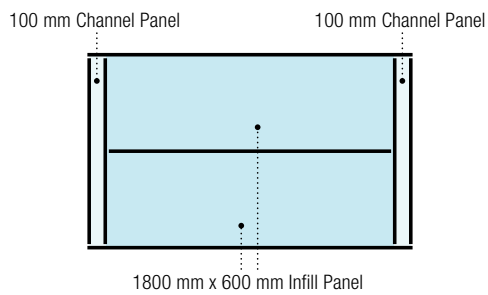

Suspension System Layout

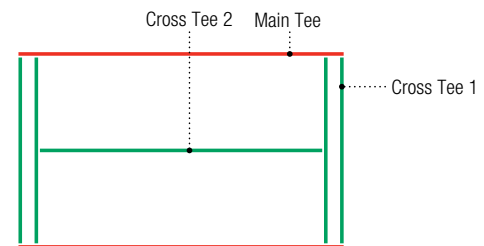

Order Information
System 139

1200mm Ceiling Module

100mm Channel

1800mm x 600mm Infill Panel



Step 1. Select Panels

Step 2. Select Edge for Panels

			FL/FLB		SL/SLT		SQ	
			Edge	Item No.	Edge	Item No.	Edge	Item No.
Infill Panels	HALCYON	600mm x 1800mm	FL	<input type="checkbox"/> ME97553	SL	<input type="checkbox"/> ME97445	SQ	<input type="checkbox"/> ME99234
	MARS	600mm x 1800mm	FLB	<input type="checkbox"/> ME88996	SLT	<input type="checkbox"/> ME86166	SQ	<input type="checkbox"/> ME86223
	MARS High-NRC	600mm x 1800mm	FLB	<input type="checkbox"/> ME89670	SLT	<input type="checkbox"/> ME89660	SQ	<input type="checkbox"/> ME86360
	PANZ Metal Panels, Solid	300mm x 1800mm	FL	<input type="checkbox"/> ME909956				

Channel Panels	HALCYON	100mm x 1200mm	FL	<input type="checkbox"/> ME97460	SL	<input type="checkbox"/> ME97430	SQ	<input type="checkbox"/> ME97402
	MARS	100mm x 1200mm	FLB	<input type="checkbox"/> ME86568	SLT	<input type="checkbox"/> ME86540	SQ	<input type="checkbox"/> ME86514
	MARS High-NRC	100mm x 1200mm	FLB	<input type="checkbox"/> ME86475	SLT	<input type="checkbox"/> ME86440	SQ	<input type="checkbox"/> ME86402
	PANZ Metal Panels, Solid	100mm x 1200mm	FL	<input type="checkbox"/> ME909947				

Step 3. Select Corresponding Grid for Selected Panels

			Qty	Item No.	Qty	Item No.	Qty	Item No.
Suspension Systems	CENTRICITEE DXT	Main Tee		<input type="checkbox"/> MEDXT24SP203				
		Cross Tee 1	2	<input type="checkbox"/> MEDXT1200				
		Cross Tee 2	1	<input type="checkbox"/> MEDXT1900				
	IDENTITEE DXI	Main Tee		<input type="checkbox"/> MEDXI24SP203				
		Cross Tee 1	2	<input type="checkbox"/> MEDXI1200				
		Cross Tee 2	1	<input type="checkbox"/> MEDXI1900				
	DONN DX	Main Tee			<input type="checkbox"/> MEDX24SP203		<input type="checkbox"/> MEDX24SP203	
		Cross Tee 1			2	<input type="checkbox"/> MEDX1200	2	<input type="checkbox"/> MEDX1200
		Cross Tee 2			1	<input type="checkbox"/> MEDX1900	1	<input type="checkbox"/> MEDX1900

Suspension System Estimator

	Length	m ²	Main Tee Usage Per m ²	Cross Tee 1 Usage Per m ²	Cross Tee 2 Usage Per m ²	
System Module	1900mm	2.280	0.833	1.053	0.833	

Note: Multiply the ceiling area (SF) by the Usage Factor (UF). This calculation will determine lineal footage of suspension system components required. Please refer to the front of this catalogue or IC592 for stabilizer bar usage.

Metric Systems









1500mm Ceiling Module

100mm Channel

System 124

700mm x 750mm Infill Panel

Selector

Channel Width	Ceiling Module	On-Center Channel Spacing	Infill Panels	Panel Edge	Suspension System	
100mm	1500mm	1500mm	HALCYON	700mm x 750mm	FL 	DXT, DXI, DXF
					SL 	DX
					SQ 	DX
			MARS	700mm x 750mm	FLB 	DXT, DXI, DXF
					SLT 	DX
					SQ 	DX
			MARS High-NRC	700mm x 750mm	FLB 	DXT, DXI, DXF
					SLT 	DX
					SQ 	DX

Module Layout

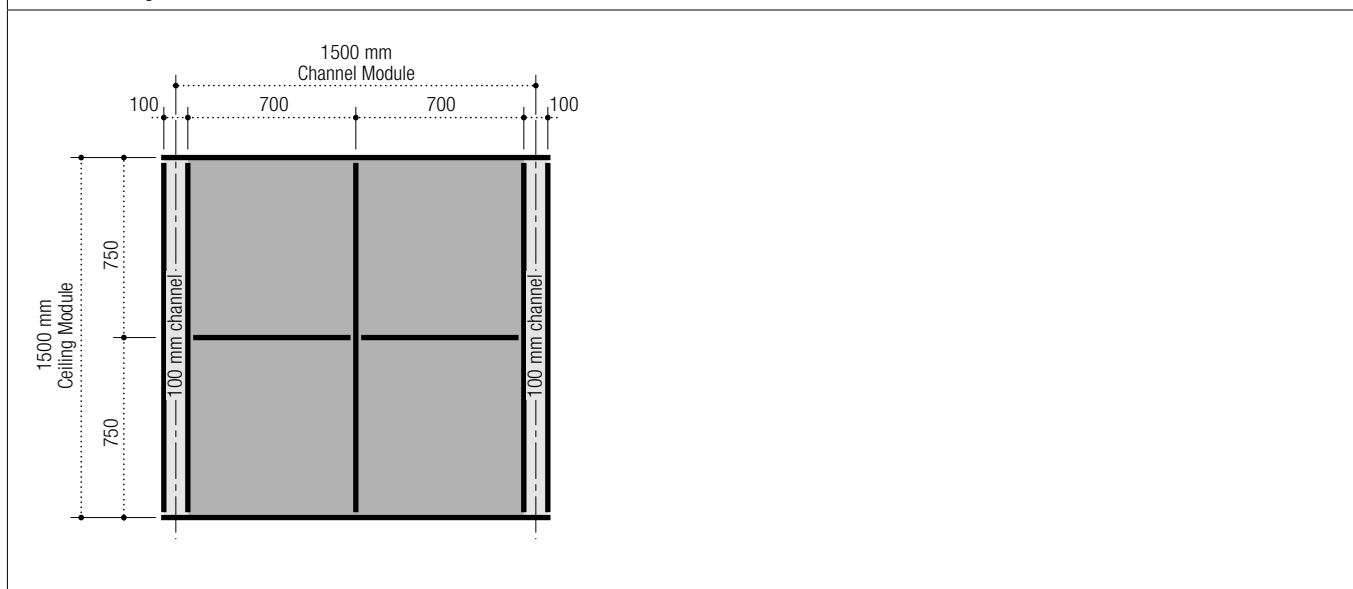

Panel Layout

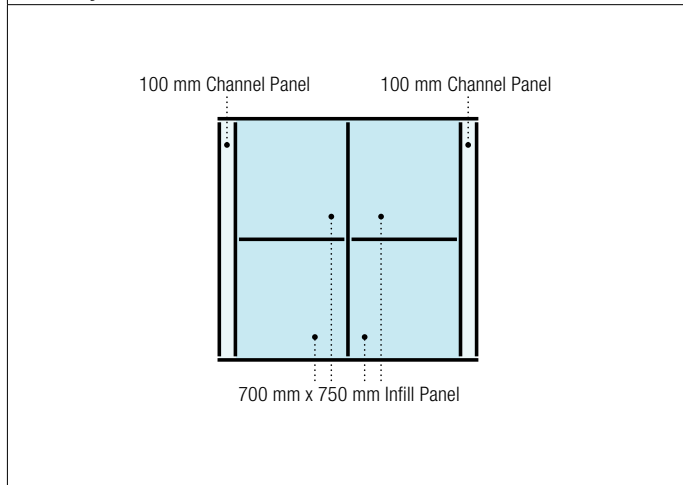

Suspension System Layout

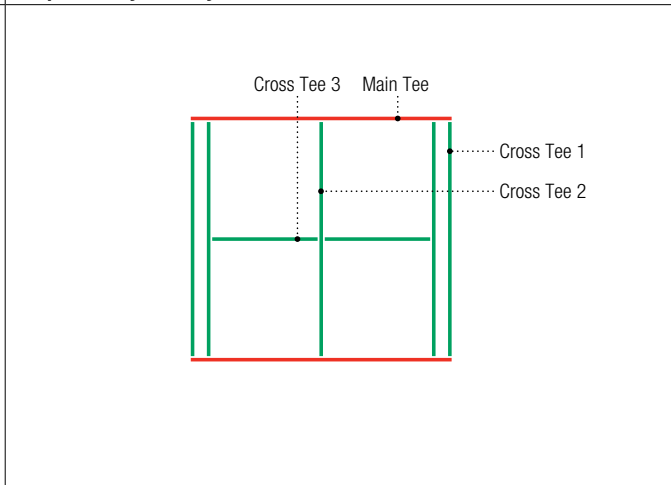

Order Information
System 124

1500mm Ceiling Module

100mm Channel
700mm x 750mm Infill Panel

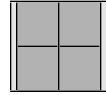

Step 1. Select Panels

Step 2. Select Edge for Panels

			FL/FLB		SL/SLT		SQ	
			Edge	Item No.	Edge	Item No.	Edge	Item No.
Infill Panels	HALCYON	700mm x 750mm	FL	<input type="checkbox"/> ME97335	SL	<input type="checkbox"/> ME97449	SQ	<input type="checkbox"/> ME97419
	MARS	700mm x 750mm	FLB	<input type="checkbox"/> ME86834	SLT	<input type="checkbox"/> ME86559	SQ	<input type="checkbox"/> ME86532
	MARS High-NRC	700mm x 750mm	FLB	<input type="checkbox"/> ME86492	SLT	<input type="checkbox"/> ME86459	SQ	<input type="checkbox"/> ME86423
	PANZ Metal Panels, Solid	700mm x 750mm	FL	<input type="checkbox"/> ME909971				

Channel Panels	HALCYON	100mm x 1500mm	FL	<input type="checkbox"/> ME97461	SL	<input type="checkbox"/> ME97431	SQ	<input type="checkbox"/> ME97403
	MARS	100mm x 1500mm	FLB	<input type="checkbox"/> ME86569	SLT	<input type="checkbox"/> ME86541	SQ	<input type="checkbox"/> ME86515
	MARS High-NRC	100mm x 1500mm	FLB	<input type="checkbox"/> ME86476	SLT	<input type="checkbox"/> ME86441	SQ	<input type="checkbox"/> ME86403
	PANZ Metal Panels, Solid	100mm x 1500mm	FL	<input type="checkbox"/> ME909949				

Step 3. Select Corresponding Grid for Selected Panels

			Qty	Item No.	Qty	Item No.	Qty	Item No.
Suspension Systems	CENTRICITEE DXT (Use with PANZ)	Main Tee		<input type="checkbox"/> MEDXT24SP205				
		Cross Tee 1	2	<input type="checkbox"/> MEDXT1500				
		Cross Tee 2	2	<input type="checkbox"/> MEDXT1400				
	IDENTITEE DXI	Main Tee		<input type="checkbox"/> MEDXI24SP205				
		Cross Tee 1	2	<input type="checkbox"/> MEDXI1500				
		Cross Tee 2	2	<input type="checkbox"/> MEDXI1400				
	DONN DX	Main Tee			<input type="checkbox"/> MEDX24SP205		<input type="checkbox"/> MEDX24SP205	
		Cross Tee 1			2	<input type="checkbox"/> MEDX1500	2	<input type="checkbox"/> MEDX1500
		Cross Tee 2			2	<input type="checkbox"/> MEDX1400	2	<input type="checkbox"/> MEDX1400

Suspension System Estimator

	Length	m ²	Main Tee Usage Per m ²	Cross Tee 1 Usage Per m ²	Cross Tee 2 Usage Per m ²	
System Module	1500mm	2.250	0.667	1.333	1.244	











Note: Multiply the ceiling area (SF) by the Usage Factor (UF). This calculation will determine lineal footage of suspension system components required. Please refer to the front of this catalogue or IC592 for stabilizer bar usage.

Metric Systems
System 110

1500mm Ceiling Module

100mm Channel
1400mm x 750mm Infill Panel

Selector

Channel Width	Ceiling Module	On-Center Channel Spacing	Infill Panels	Panel Edge	Suspension System
100mm	1500mm	1500mm	HALCYON 1400mm x 750mm	FL 	DXT, DXI, DXF
				SL 	DX
				SQ 	DX
			MARS 1400mm x 750mm	FLB 	DXT, DXI, DXF
				SLT 	DX
				SQ 	DX
			MARS High-NRC 1400mm x 750mm	FLB 	DXT, DXI, DXF
				SLT 	DX
				SQ 	DX
			PANZ Metal Panels, Solid 1400mm x 750mm	FL 	DXT, DXI

Module Layout

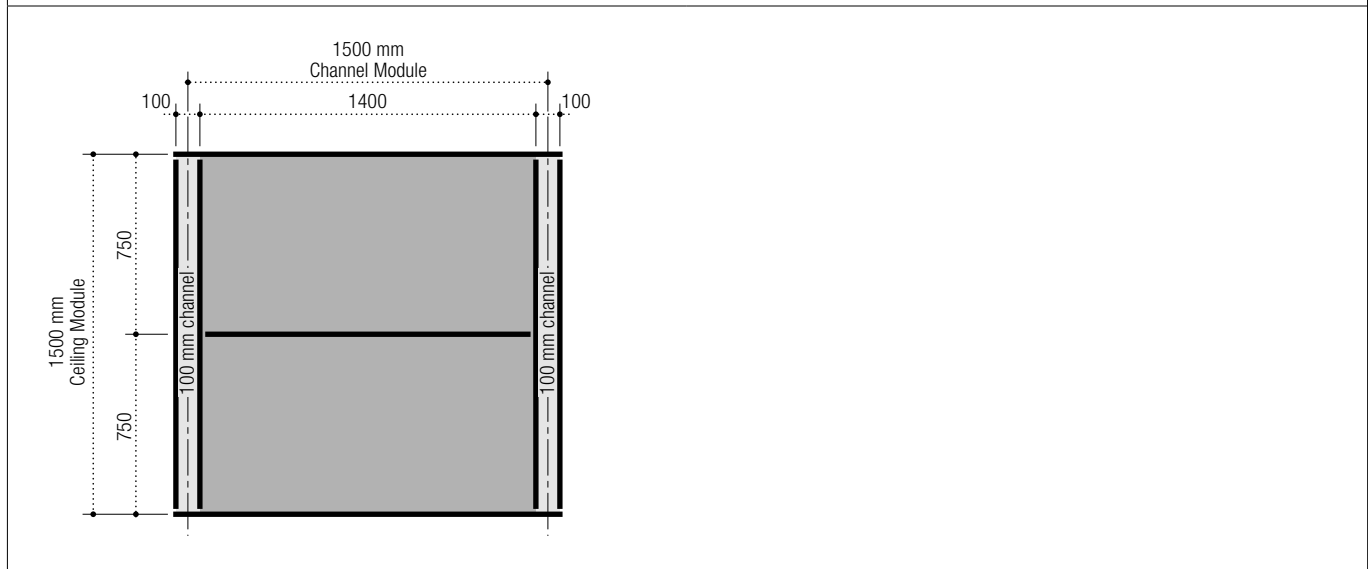

Panel Layout

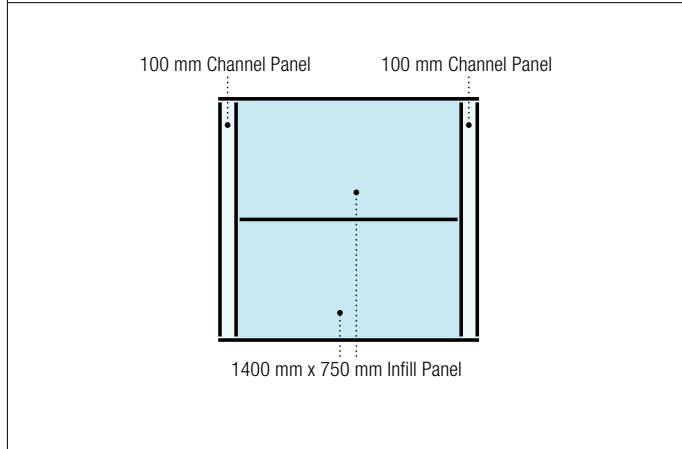

Suspension System Layout

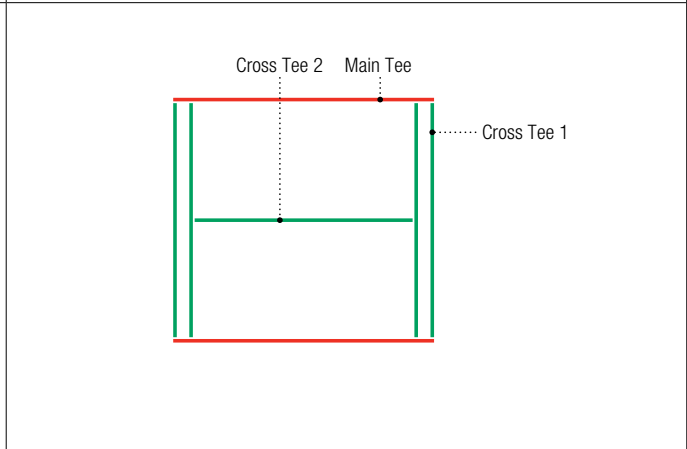

Order Information
System 110

1500mm Ceiling Module

100mm Channel

1400mm x 750mm Infill Panel



Step 1. Select Panels

Step 2. Select Edge for Panels

			FL/FLB		SL/SLT		SQ	
			Edge	Item No.	Edge	Item No.	Edge	Item No.
Infill Panels	HALCYON	1400mm x 750mm	FL	<input type="checkbox"/> ME97473	SL	<input type="checkbox"/> ME98453	SQ	<input type="checkbox"/> ME97423
	MARS	1400mm x 750mm	FLB	<input type="checkbox"/> ME86583	SLT	<input type="checkbox"/> ME86563	SQ	<input type="checkbox"/> ME86535
	MARS High-NRC	1400mm x 750mm	FLB	<input type="checkbox"/> ME86496	SLT	<input type="checkbox"/> ME86465	SQ	<input type="checkbox"/> ME86428
	PANZ Metal Panels, Solid	1400mm x 750mm	FL	<input type="checkbox"/> ME909973				

Channel Panels	HALCYON	100mm x 1500mm	FL	<input type="checkbox"/> ME97461	SL	<input type="checkbox"/> ME97431	SQ	<input type="checkbox"/> ME97403
	MARS	100mm x 1500mm	FLB	<input type="checkbox"/> ME86569	SLT	<input type="checkbox"/> ME86541	SQ	<input type="checkbox"/> ME86515
	MARS High-NRC	100mm x 1500mm	FLB	<input type="checkbox"/> ME86476	SLT	<input type="checkbox"/> ME86441	SQ	<input type="checkbox"/> ME86403
	PANZ Metal Panels, Solid	100mm x 1500mm	FL	<input type="checkbox"/> ME99949				

Step 3. Select Corresponding Grid for Selected Panels











			Qty	Item No.	Qty	Item No.	Qty	Item No.
Suspension Systems	CENTRICITEE DXT	Main Tee		<input type="checkbox"/> DXT24SP205				
		Cross Tee 1	2	<input type="checkbox"/> DXT1500				
		Cross Tee 2	1	<input type="checkbox"/> DXT1500				
		Cross Tee 3	2	<input type="checkbox"/> DXT700				
	IDENTITEE DXI	Main Tee		<input type="checkbox"/> DXI24SP205				
		Cross Tee 1	2	<input type="checkbox"/> DXI1500				
		Cross Tee 2	1	<input type="checkbox"/> DXI1500				
		Cross Tee 3	2	<input type="checkbox"/> DXI700				
	DONN DX	Main Tee				<input type="checkbox"/> DX24SP205		<input type="checkbox"/> DX24SP205
		Cross Tee 1			2	<input type="checkbox"/> DX1500	2	<input type="checkbox"/> DX1500
		Cross Tee 2			1	<input type="checkbox"/> DX1500	1	<input type="checkbox"/> DX1500
		Cross Tee 3			2	<input type="checkbox"/> DX700	2	<input type="checkbox"/> DX700

Suspension System Estimator

	Length	m ²	Main Tee Usage Per m ²	Cross Tee 1 Usage Per m ²	Cross Tee 2 Usage Per m ²	Cross Tee 3 Usage Per m ²
System Module	1500mm	2.250	0.667	1.333	0.667	0.622

Note: Multiply the ceiling area (SF) by the Usage Factor (UF). This calculation will determine lineal footage of suspension system components required. Please refer to the front of this catalogue or IC592 for stabilizer bar usage.

Selector

Channel Width	Ceiling Module	On-Center Channel Spacing	Infill Panels	Panel Edge	Suspension System			
100mm	1500mm	1500mm	HALCYON	1400mm x 500mm	FL 	DXT, DXI, DXF		
					SL 	DX		
					SQ 	DX		
			MARS	1400mm x 500mm	FLB 	DXT, DXI, DXF		
					SLT 	DX		
					SQ 	DX		
			MARS High-NRC	1400mm x 500mm	FLB 	DXT, DXI, DXF		
					SLT 	DX		
					SQ 	DX		
			PANZ Metal Panels, Solid			1400mm x 500mm	FL 	DXT, DXI

Module Layout

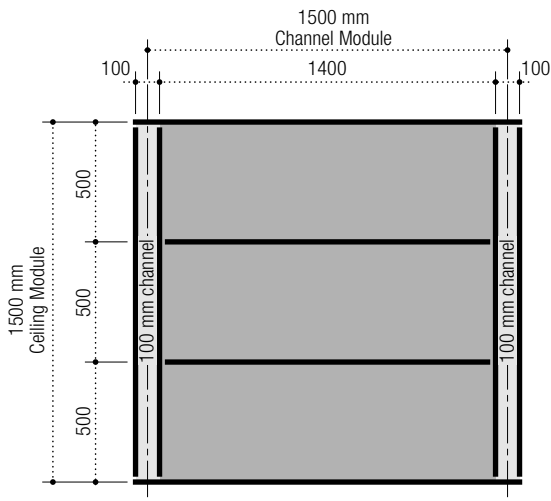

Panel Layout

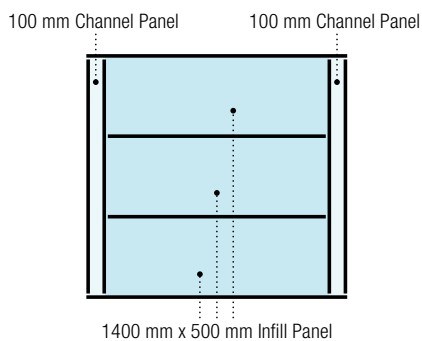

Suspension System Layout

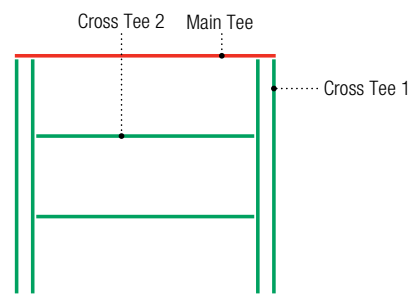

Order Information
System 102

1500mm Ceiling Module

100mm Channel

1400mm x 500mm Infill Panel

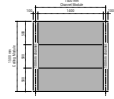

Step 1. Select Panels

Step 2. Select Edge for Panels

			FL/FLB		SL/SLT		SQ	
			Edge	Item No.	Edge	Item No.	Edge	Item No.
Infill Panels	HALCYON	1400mm x 500mm	FL	<input type="checkbox"/> ME97464	SL	<input type="checkbox"/> ME97437	SQ	<input type="checkbox"/> ME97408
	MARS	1400mm x 500mm	FLB	<input type="checkbox"/> ME86571	SLT	<input type="checkbox"/> ME86548	SQ	<input type="checkbox"/> ME86520
	MARS High-NRC	1400mm x 500mm	FLB	<input type="checkbox"/> ME86480	SLT	<input type="checkbox"/> ME86448	SQ	<input type="checkbox"/> ME86411
	PANZ Metal Panels, Solid	300mm x 1800mm	FL	<input type="checkbox"/> ME909956				

Channel Panels	HALCYON	100mm x 1500mm	FL	<input type="checkbox"/> ME97461	SL	<input type="checkbox"/> ME97431	SQ	<input type="checkbox"/> ME97403
	MARS	100mm x 1500mm	FLB	<input type="checkbox"/> ME86569	SLT	<input type="checkbox"/> ME86541	SQ	<input type="checkbox"/> ME86515
	MARS High-NRC	100mm x 1500mm	FLB	<input type="checkbox"/> ME86476	SLT	<input type="checkbox"/> ME86441	SQ	<input type="checkbox"/> ME86403
	PANZ Metal Panels, Solid	100mm x 1500mm	FL	<input type="checkbox"/> ME909949				

Step 3. Select Corresponding Grid for Selected Panels

			Qty	Item No.	Qty	Item No.	Qty	Item No.
Suspension Systems	CENTRICITEE DXT	Main Tee		<input type="checkbox"/> MEDXT24SP205				
		Cross Tee 1	2	<input type="checkbox"/> MEDXT1000				
	IDENTITEE DXI	Main Tee		<input type="checkbox"/> MEDXI24SP205				
		Cross Tee 1	2	<input type="checkbox"/> MEDXI1000				
	DONN DX	Main Tee			<input type="checkbox"/> MEDX24SP205		<input type="checkbox"/> MEDX24SP205	
		Cross Tee 1			2	<input type="checkbox"/> MEDX1000	2	<input type="checkbox"/> MEDX1000

Suspension System Estimator

	Length	m ²	Main Tee Usage Per m ²	Cross Tee 1 Usage Per m ²	
System Module	1500mm	1.500	1.000	1.333	



Note: Multiply the ceiling area (SF) by the Usage Factor (UF). This calculation will determine lineal footage of suspension system components required. Please refer to the front of this catalogue or IC592 for stabilizer bar usage.

Metric Systems
System 129

1500mm Ceiling Module

100mm Channel
1400mm x 1500mm Infill Panel

Selector

Channel Width	Ceiling Module	On-Center Channel Spacing	Infill Panels	Panel Edge	Suspension System
10mm	1500mm	1500mm	HALCYON 1400mm x 1500mm	FL  SL  SQ 	DXT, DXI, DXF DX DX

Module Layout

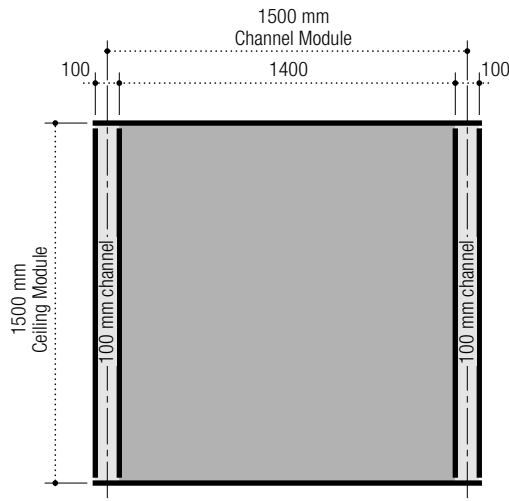

Panel Layout

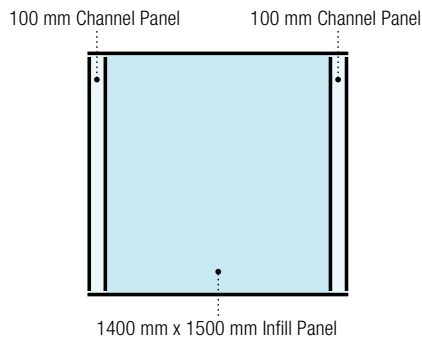

Suspension System Layout

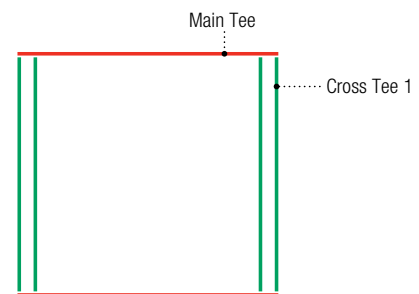

Order Information

1500mm Ceiling Module

100mm Channel



System 129

1400mm x 1500mm Infill Panel

Step 1. Select Panels

Step 2. Select Edge for Panels

			FL/FLB		SL/SLT		SQ	
			Edge	Item No.	Edge	Item No.	Edge	Item No.
Infill Panels	HALCYON	1400mm x 1500mm	FL	<input type="checkbox"/> ME99229	SL	<input type="checkbox"/> ME97537	SQ	<input type="checkbox"/> ME97567
Channel Panels	HALCYON	100mm x 1500mm	FL	<input type="checkbox"/> ME97461	SL	<input type="checkbox"/> ME97431	SQ	<input type="checkbox"/> ME97403
	PANZ Metal Panels, Solid	100mm x 1500mm	FL	<input type="checkbox"/> ME909949				

Step 3. Select Corresponding Grid for Selected Panels

			Qty	Item No.	Qty	Item No.	Qty	Item No.
Suspension Systems	CENTRICITEE DXT	Main Tee		<input type="checkbox"/> MEDXT24SP205				
		Cross Tee 1	2	<input type="checkbox"/> MEDXT1500				
		Cross Tee 2	1	<input type="checkbox"/> MEDXT1400				
	IDENTITEE DXI	Main Tee		<input type="checkbox"/> MEDXI24SP205				
		Cross Tee 1	2	<input type="checkbox"/> MEDXI1500				
		Cross Tee 2	1	<input type="checkbox"/> MEDXI1400				
	DONN DX	Main Tee				<input type="checkbox"/> MEDX24SP205		<input type="checkbox"/> MEDX24SP205
		Cross Tee 1			2	<input type="checkbox"/> MEDX1500	2	<input type="checkbox"/> MEDX1500
		Cross Tee 2			1	<input type="checkbox"/> MEDX1400	1	<input type="checkbox"/> MEDX1400

Suspension System Estimator

	Length	m ²	Main Tee Usage Per m ²	Cross Tee 1 Usage Per m ²	Cross Tee 2 Usage Per m ²	
System Module	1500mm	2.250	0.667	1.333	0.622	









Note: Multiply the ceiling area (SF) by the Usage Factor (UF). This calculation will determine lineal footage of suspension system components required. Please refer to the front of this catalogue or IC592 for stabilizer bar usage.

Metric Systems
System 136

1000mm Ceiling Module

150mm Channel
675mm x 500mm Infill Panel

Selector

Channel Width	Ceiling Module	On-Center Channel Spacing	Infill Panels	Panel Edge	Suspension System
150mm	1000mm	1500mm	HALCYON	675mm x 500mm	FL  DXT, DXI, DXF
					SL  DX
					SQ  DX
			MARS	675mm x 500mm	FLB  DXT, DXI, DXF
					SLT  DX
					SQ  DX
			MARS High-NRC	675mm x 500mm	FLB  DXT, DXI, DXF
					SLT  DX
					SQ  DX

Module Layout

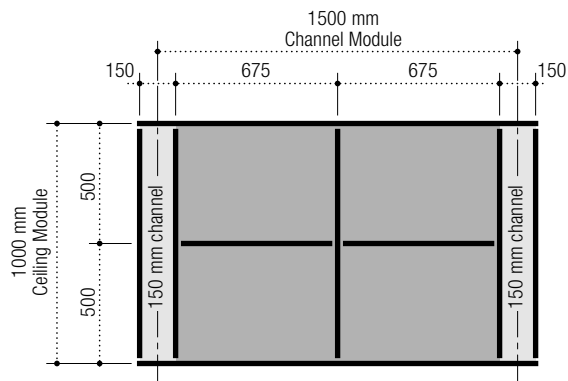

Panel Layout

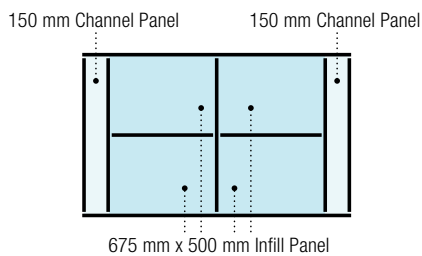

Suspension System Layout

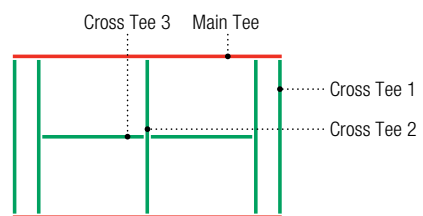

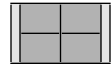

Step 1. Select Panels

Step 2. Select Edge for Panels

			FL/FLB		SL/SLT		SQ	
			Edge	Item No.	Edge	Item No.	Edge	Item No.
Infill Panels	HALCYON	675mm x 500mm	FL	<input type="checkbox"/> ME97544	SL	<input type="checkbox"/> ME97515	SQ	<input type="checkbox"/> ME97486
	MARS	675mm x 500mm	FLB	<input type="checkbox"/> ME86648	SLT	<input type="checkbox"/> ME86625	SQ	<input type="checkbox"/> ME86599
	MARS High-NRC	675mm x 500mm	FLB	<input type="checkbox"/> ME86069	SLT	<input type="checkbox"/> ME86044	SQ	<input type="checkbox"/> ME86015
	PANZ Metal Panels, Solid	675mm x 500mm	FL	<input type="checkbox"/> ME909960				
Channel Panels	HALCYON	150mm x 1000mm	FL	<input type="checkbox"/> ME98198	SL	<input type="checkbox"/> ME99271	SQ	<input type="checkbox"/> ME97227
	PANZ Metal Panels, Solid	150mm x 1000mm	FL	<input type="checkbox"/> ME909953				

Step 3. Select Corresponding Grid for Selected Panels

			Qty	Item No.	Qty	Item No.	Qty	Item No.
Suspension Systems	CENTRICITEE DXT	Main Tee		<input type="checkbox"/> MEDXT24SP206				
		Cross Tee 1	2	<input type="checkbox"/> MEDXT1000				
		Cross Tee 2	1	<input type="checkbox"/> MEDXT1000				
		Cross Tee 3	2	<input type="checkbox"/> MEDXT675				
	IDENTITEE DXI	Main Tee		<input type="checkbox"/> MEDXI24SP206				
		Cross Tee 1	2	<input type="checkbox"/> MEDXI1000				
		Cross Tee 2	1	<input type="checkbox"/> MEDXI1000				
		Cross Tee 3	2	<input type="checkbox"/> MEDXI675				
	DONN DX	Main Tee			<input type="checkbox"/> MEDX24SP206		<input type="checkbox"/> MEDX24SP206	
		Cross Tee 1			2	<input type="checkbox"/> MEDX1000	2	<input type="checkbox"/> MEDX1000
		Cross Tee 2			1	<input type="checkbox"/> MEDX1000	1	<input type="checkbox"/> MEDX1000
		Cross Tee 3			2	<input type="checkbox"/> MEDXI675	2	<input type="checkbox"/> MEDXI675

Suspension System Estimator

	Length	m ²	Main Tee Usage Per m ²	Cross Tee 1 Usage Per m ²	Cross Tee 2 Usage Per m ²	Cross Tee 3 Usage Per m ²
System Module	1500mm	1.500	1.000	1.333	0.667	0.900









Note: Multiply the ceiling area (SF) by the Usage Factor (UF). This calculation will determine lineal footage of suspension system components required. Please refer to the front of this catalogue or IC592 for stabilizer bar usage.

Metric Systems
System 122

1000mm Ceiling Module

150mm Channel
1350mm x 500mm Infill Panel

Selector

Channel Width	Ceiling Module	On-Center Channel Spacing	Infill Panels	Panel Edge	Suspension System	
150mm	1000mm	1500mm	HALCYON	1350mm x 500mm	FL 	DXT, DXI, DXF
					SL 	DX
					SQ 	DX
			MARS	1350mm x 500mm	FLB 	DXT, DXI, DXF
					SLT 	DX
					SQ 	DX
			MARS High-NRC	1350mm x 500mm	FLB 	DXT, DXI, DXF
					SLT 	DX
					SQ 	DX

Module Layout

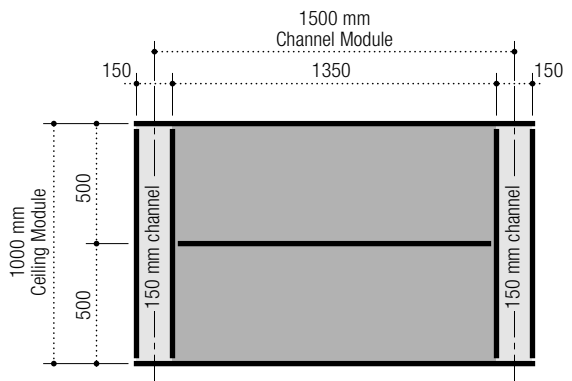

Panel Layout

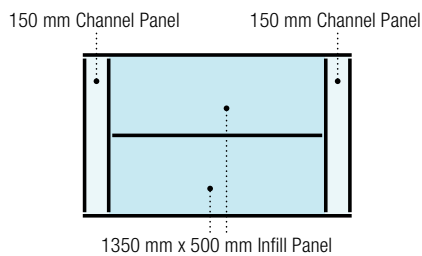

Suspension System Layout

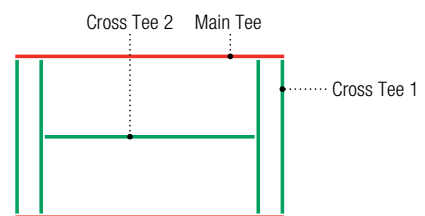

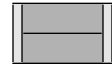

Step 1. Select Panels

Step 2. Select Edge for Panels

			FL/FLB		SL/SLT		SQ	
			Edge	Item No.	Edge	Item No.	Edge	Item No.
Infill Panels	HALCYON	1350mm x 500mm	FL	<input type="checkbox"/> ME98360	SL	<input type="checkbox"/> ME97436	SQ	<input type="checkbox"/> ME97407
	MARS	1350mm x 500mm	FLB	<input type="checkbox"/> ME88845	SLT	<input type="checkbox"/> ME86547	SQ	<input type="checkbox"/> ME86519
	MARS High-NRC	1350mm x 500mm	FLB	<input type="checkbox"/> ME86479	SLT	<input type="checkbox"/> ME86447	SQ	<input type="checkbox"/> ME86410

Channel Panels	HALCYON	150mm x 1000mm	FL	<input type="checkbox"/> ME98198	SL	<input type="checkbox"/> ME99271	SQ	<input type="checkbox"/> ME97227
	PANZ Metal Panels, Solid	150mm x 1000mm	FL	<input type="checkbox"/> ME909953				

Step 3. Select Corresponding Grid for Selected Panels

			Qty	Item No.	Qty	Item No.	Qty	Item No.
Suspension Systems	CENTRICITEE DXT	Main Tee		<input type="checkbox"/> MEDXT24SP206				
		Cross Tee 1	2	<input type="checkbox"/> MEDXT1000				
		Cross Tee 2	1	<input type="checkbox"/> MEDXT1350				
	IDENTITEE DXI	Main Tee		<input type="checkbox"/> MEDXI24SP206				
		Cross Tee 1	2	<input type="checkbox"/> MEDXI1000				
		Cross Tee 2	1	<input type="checkbox"/> MEDXI1350				
	DONN DX	Main Tee				<input type="checkbox"/> MEDX24SP206		<input type="checkbox"/> MEDX24SP206
		Cross Tee 1			2	<input type="checkbox"/> MEDX1000	2	<input type="checkbox"/> MEDX1000
		Cross Tee 2			1	<input type="checkbox"/> MEDX1350	1	<input type="checkbox"/> MEDX1350

Suspension System Estimator

	Length	m ²	Main Tee Usage Per m ²	Cross Tee 1 Usage Per m ²	Cross Tee 2 Usage Per m ²	
System Module	1500mm	1.500	1.000	1.333	0.900	



Note: Multiply the ceiling area (SF) by the Usage Factor (UF). This calculation will determine lineal footage of suspension system components required. Please refer to the front of this catalogue or IC592 for stabilizer bar usage.

Metric Systems
System 107

1000mm Ceiling Module

150mm Channel
1350mm x 1000mm Infill Panel

Selector

Channel Width	Ceiling Module	On-Center Channel Spacing	Infill Panels	Panel Edge	Suspension System
150mm	1000mm	1500mm	HALCYON	1350mm x 1000mm	FL  DXT, DXI, DXF
					SL  DX
					SQ  DX

Module Layout

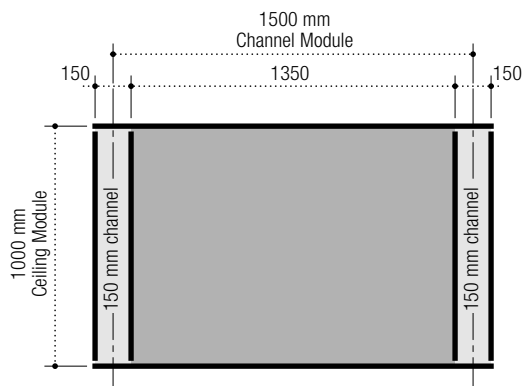

Panel Layout

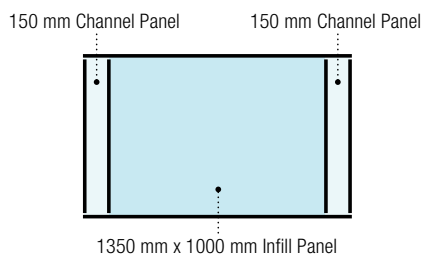

Suspension System Layout

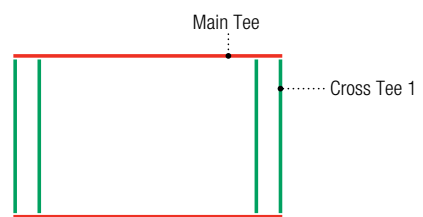

Order Information
System 107

1000mm Ceiling Module

150mm Channel

1350mm x 1000mm Infill Panel



Step 1. Select Panels

Step 2. Select Edge for Panels

			FL/FLB		SL/SLT		SQ	
			Edge	Item No.	Edge	Item No.	Edge	Item No.
Infill Panels	HALCYON	1350mm x 1000mm	FL	<input type="checkbox"/> ME97558	SL	<input type="checkbox"/> ME97529	SQ	<input type="checkbox"/> ME97501

Channel Panels	HALCYON	150mm x 1000mm	FL	<input type="checkbox"/> ME97541	SL	<input type="checkbox"/> ME97512	SQ	<input type="checkbox"/> ME97483
	PANZ Metal Panels, Solid	150mm x 1000mm	FL	<input type="checkbox"/> ME909953				

Step 3. Select Corresponding Grid for Selected Panels

			Qty	Item No.	Qty	Item No.	Qty	Item No.
Suspension Systems	CENTRICITEE DXT	Main Tee		<input type="checkbox"/> MEDXT24SP206				
		Cross Tee 1	2	<input type="checkbox"/> MEDXT1000				
	IDENTITEE DXI	Main Tee		<input type="checkbox"/> MEDXI24SP206				
		Cross Tee 1	2	<input type="checkbox"/> MEDXI1000				
	DONN DX	Main Tee			<input type="checkbox"/> MEDX24SP206		<input type="checkbox"/> MEDX24SP206	
		Cross Tee 1			2	<input type="checkbox"/> MEDX1000	2	<input type="checkbox"/> MEDX1000

Suspension System Estimator

	Length	m ²	Main Tee Usage Per m ²	Cross Tee 1 Usage Per m ²	
System Module	1500mm	1.500	1.000	1.333	









Note: Multiply the ceiling area (SF) by the Usage Factor (UF). This calculation will determine lineal footage of suspension system components required. Please refer to the front of this catalogue or IC592 for stabilizer bar usage.

Metric Systems
System 113

1200mm Ceiling Module

150mm Channel
525mm x 600mm Infill Panel

Selector

Channel Width	Ceiling Module	On-Center Channel Spacing	Infill Panels	Panel Edge	Suspension System
150mm	1200mm	1200mm	HALCYON	525mm x 600mm	FL  DXT, DXI, DXF
					SL  DX
					SQ  DX, DXT
			MARS	525mm x 600mm	FLB  DXT, DXI, DXF
					SLT  DX
					SQ  DX, DXT
			MARS High-NRC	525mm x 600mm	FLB  DXT, DXI, DXF
					SLT  DX
					SQ  DX, DXT

Module Layout

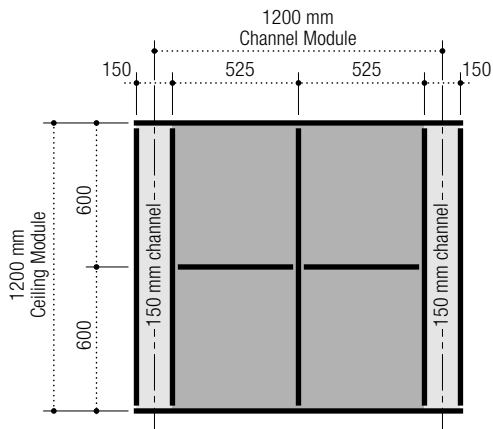

Panel Layout

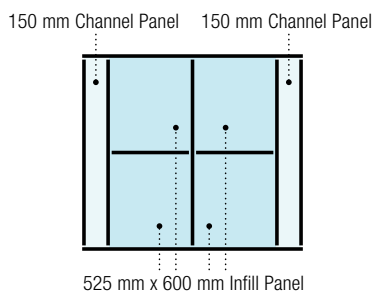

Suspension System Layout

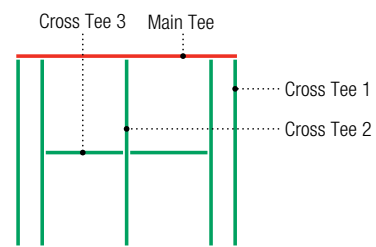



Step 1. Select Panels

Step 2. Select Edge for Panels

			FL/FLB		SL/SLT		SQ	
			Edge	Item No.	Edge	Item No.	Edge	Item No.
Infill Panels	HALCYON	525mm x 600mm	FL	<input type="checkbox"/> ME98195	SL	<input type="checkbox"/> ME98220	SQ	<input type="checkbox"/> ME97411
	MARS	525mm x 600mm	FLB	<input type="checkbox"/> ME88840	SLT	<input type="checkbox"/> ME86550	SQ	<input type="checkbox"/> ME86522
	MARS High-NRC	525mm x 600mm	FLB	<input type="checkbox"/> ME86483	SLT	<input type="checkbox"/> ME86451	SQ	<input type="checkbox"/> ME86414

Channel Panels	HALCYON	150mm x 1200mm	FL	<input type="checkbox"/> ME97572	SL	<input type="checkbox"/> ME97493	SQ	<input type="checkbox"/> ME97479
	MARS	150mm x 1200mm	FLB	<input type="checkbox"/> ME88887	SLT	<input type="checkbox"/> ME86542	SQ	<input type="checkbox"/> ME86325
	MARS High-NRC	150mm x 1200mm	FLB	<input type="checkbox"/> ME86331	SLT	<input type="checkbox"/> ME86442	SQ	<input type="checkbox"/> ME86404
	PANZ Metal Panels, Solid	150mm x 1200mm	FL	<input type="checkbox"/> ME909954				

Step 3. Select Corresponding Grid for Selected Panels

			Qty	Item No.	Qty	Item No.	Qty	Item No.
Suspension Systems	CENTRICITEE DXT	Main Tee		<input type="checkbox"/> MEDXT24SP204				<input type="checkbox"/> MEDXT24SP204
		Cross Tee 1	2	<input type="checkbox"/> MEDXT1200			2	<input type="checkbox"/> MEDXT1200
		Cross Tee 2	1	<input type="checkbox"/> MEDXT1200			1	<input type="checkbox"/> MEDXT1200
		Cross Tee 3	2	<input type="checkbox"/> MEDXT525			2	<input type="checkbox"/> MEDXT525
	IDENTITEE DXI	Main Tee		<input type="checkbox"/> MEDXI24SP204				
		Cross Tee 1	2	<input type="checkbox"/> MEDXI1200				
		Cross Tee 2	1	<input type="checkbox"/> MEDXI1200				
		Cross Tee 3	2	<input type="checkbox"/> MEDXI525				
	DONN DX	Main Tee				<input type="checkbox"/> MEDX24SP204		<input type="checkbox"/> MEDX24SP204
		Cross Tee 1			2	<input type="checkbox"/> MEDX1200	2	<input type="checkbox"/> MEDX1200
		Cross Tee 2			1	<input type="checkbox"/> MEDX1200	1	<input type="checkbox"/> MEDX1200
		Cross Tee 3			2	<input type="checkbox"/> MEDX525	2	<input type="checkbox"/> MEDX525

Suspension System Estimator

	Length	m ²	Main Tee Usage Per m ²	Cross Tee 1 Usage Per m ²	Cross Tee 2 Usage Per m ²	Cross Tee 3 Usage Per m ²
System Module	1200mm	1.440	0.833	1.667	0.833	0.729



Note: Multiply the ceiling area (SF) by the Usage Factor (UF). This calculation will determine lineal footage of suspension system components required. Please refer to the front of this catalogue or IC592 for stabilizer bar usage.

Metric Systems
System 109

1200mm Ceiling Module

150mm Channel
1050mm x 600mm Infill Panel

Selector

Channel Width	Ceiling Module	On-Center Channel Spacing	Infill Panels	Panel Edge	Suspension System
150mm	1200mm	1200mm	HALCYON	1050mm x 600mm	FL  DXT, DXI, DXF
					SL  DX
					SQ  DX

Module Layout

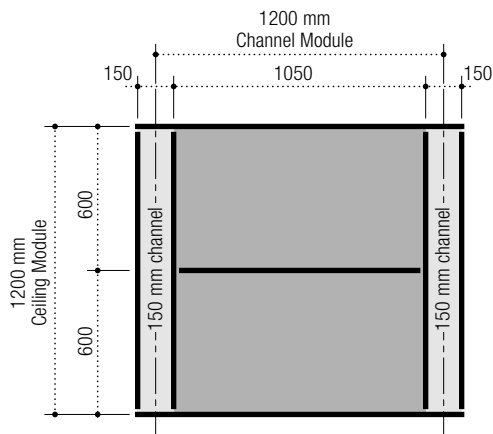

Panel Layout

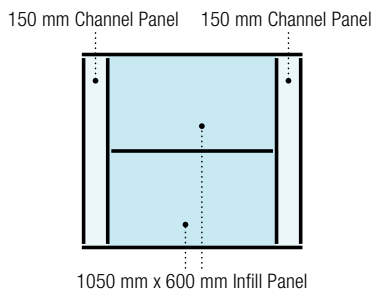

Suspension System Layout

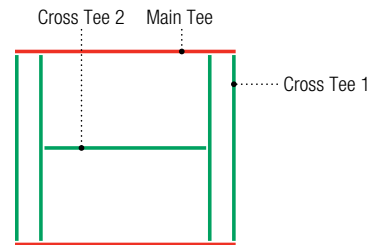

Order Information
System 109

1200mm Ceiling Module

150mm Channel

1050mm x 600mm Infill Panel



Step 1. Select Panels

Step 2. Select Edge for Panels

			FL/FLB		SL/SLT		SQ	
			Edge	Item No.	Edge	Item No.	Edge	Item No.
Infill Panels	HALCYON	1050mm x 600mm	FL	<input type="checkbox"/> ME97560	SL	<input type="checkbox"/> ME97531	SQ	<input type="checkbox"/> ME97503

Channel Panels	HALCYON	150mm x 1200mm	FL	<input type="checkbox"/> ME97572	SL	<input type="checkbox"/> ME97493	SQ	<input type="checkbox"/> ME97479
	PANZ Metal Panels, Solid	150mm x 1200mm	FL	<input type="checkbox"/> ME909954				

Step 3. Select Corresponding Grid for Selected Panels

			Qty	Item No.	Qty	Item No.	Qty	Item No.
Suspension Systems	CENTRICITEE DXT	Main Tee		<input type="checkbox"/> MEDXT24SP204				
		Cross Tee 1	2	<input type="checkbox"/> MEDXT1200				
		Cross Tee 2	1	<input type="checkbox"/> MEDXT1050				
	IDENTITEE DXI	Main Tee		<input type="checkbox"/> MEDXI24SP204				
		Cross Tee 1	2	<input type="checkbox"/> MEDXI1200				
		Cross Tee 2	1	<input type="checkbox"/> MEDXI1050				
	DONN DX	Main Tee				<input type="checkbox"/> MEDX24SP204		<input type="checkbox"/> MEDX24SP204
		Cross Tee 1			2	<input type="checkbox"/> MEDX1200	2	<input type="checkbox"/> MEDX1200
		Cross Tee 2			1	<input type="checkbox"/> MEDX1050	1	<input type="checkbox"/> MEDX1050

Suspension System Estimator

	Length	m ²	Main Tee Usage Per m ²	Cross Tee 1 Usage Per m ²	Cross Tee 2 Usage Per m ²	
System Module	1200mm	1.440	0.833	1.667	0.729	



Note: Multiply the ceiling area (SF) by the Usage Factor (UF). This calculation will determine lineal footage of suspension system components required. Please refer to the front of this catalogue or IC592 for stabilizer bar usage.

Metric Systems
System 101

1200 mm Ceiling Module

150mm Channel
1050mm x 1200mm Infill Panel

Selector

Channel Width	Ceiling Module	On-Center Channel Spacing	Infill Panels	Panel Edge	Suspension System
150mm	1200mm	1200mm	HALCYON	1050mm x 1200mm	FL  DXT, DXI, DXF
					SL  DX
					SQ  DX

Module Layout

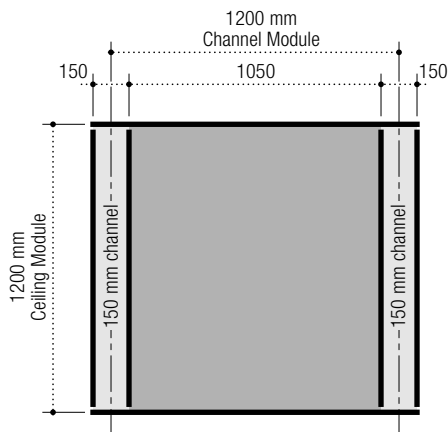

Panel Layout

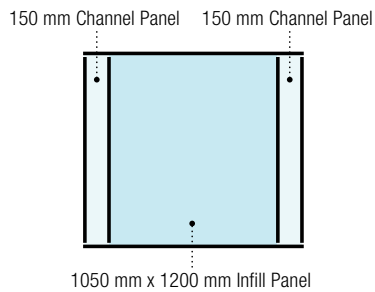

Suspension System Layout

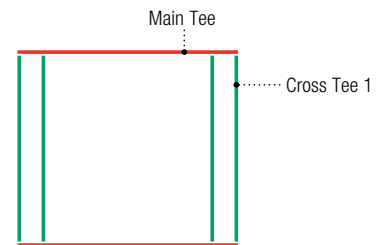

Order Information
System 101

1200mm Ceiling Module

150mm Channel

1050mm x 1200mm Infill Panel



Step 1. Select Panels

Step 2. Select Edge for Panels

			FL/FLB		SL/SLT		SQ	
			Edge	Item No.	Edge	Item No.	Edge	Item No.
Infill Panels	HALCYON	1050mm x 1200mm	FL	<input type="checkbox"/> ME97561	SL	<input type="checkbox"/> ME97532	SQ	<input type="checkbox"/> ME97504

Channel Panels	HALCYON	150mm x 1200mm	FL	<input type="checkbox"/> ME97572	SL	<input type="checkbox"/> ME97493	SQ	<input type="checkbox"/> ME97479
	PANZ Metal Panels, Solid	150mm x 1200mm	FL	<input type="checkbox"/> ME909954				

Step 3. Select Corresponding Grid for Selected Panels

			Qty	Item No.	Qty	Item No.	Qty	Item No.
Suspension Systems	CENTRICITEE DXT	Main Tee		<input type="checkbox"/> MEDXT24SP204				
		Cross Tee 1	2	<input type="checkbox"/> MEDXT1200				
	IDENTITEE DXI	Main Tee		<input type="checkbox"/> MEDXI24SP204				
		Cross Tee 1	2	<input type="checkbox"/> MEDXI1200				
	DONN DX	Main Tee			<input type="checkbox"/> MEDX24SP204		<input type="checkbox"/> MEDX24SP204	
		Cross Tee 1			2	<input type="checkbox"/> MEDX1200	2	<input type="checkbox"/> MEDX1200

Suspension System Estimator

	Length	m ²	Main Tee Usage Per m ²	Cross Tee 1 Usage Per m ²	
System Module	1200mm	1.440	0.833	1.667	











Note: Multiply the ceiling area (SF) by the Usage Factor (UF). This calculation will determine lineal footage of suspension system components required. Please refer to the front of this catalogue or IC592 for stabilizer bar usage.

Metric Systems
System 127

1200mm Ceiling Module

150mm Channel
600mm x 600mm Infill Panel

Selector

Channel Width	Ceiling Module	On-Center Channel Spacing	Infill Panels	Panel Edge	Suspension System
150mm	1200mm	1350mm	HALCYON	600mm x 600mm	FL  DXT, DXI, DXF
					SL  DX
					SQ  DX, DXT
			MARS	600mm x 600mm	FLB  DXT, DXI, DXF
					SLT  DX
					SQ  DX, DXT
			MARS High-NRC	600mm x 600mm	FLB  DXT, DXI, DXF
					SLT  DX
					SQ  DX, DXT
			PANZ Metal Panels, Solid	600mm x 600mm	FL  DXT, DXI

Module Layout

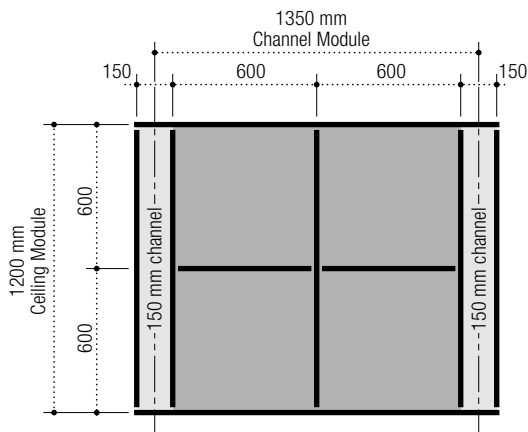

Panel Layout

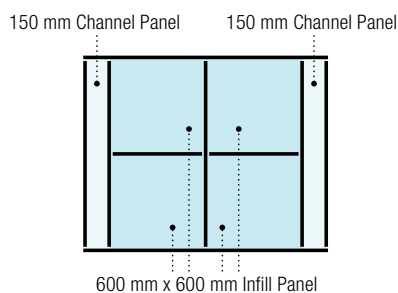

Suspension System Layout

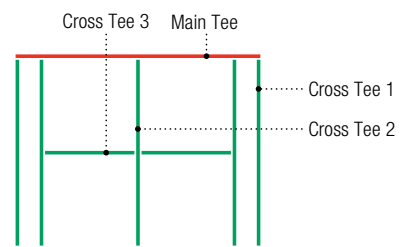

Order Information
System 127

1200mm Ceiling Module

150mm Channel
600mm x 600mm Infill Panel



Step 1. Select Panels

Step 2. Select Edge for Panels

			FL/FLB		SL/SLT		SQ	
			Edge	Item No.	Edge	Item No.	Edge	Item No.
Infill Panels	HALCYON	600mm x 600mm	FL	<input type="checkbox"/> ME98225	SL	<input type="checkbox"/> ME98223	SQ	<input type="checkbox"/> ME98221
	MARS	600mm x 600mm	FLB	<input type="checkbox"/> ME86985	SLT	<input type="checkbox"/> ME86785	SQ	<input type="checkbox"/> ME86185
	MARS High-NRC	600mm x 600mm	FLB	<input type="checkbox"/> ME87100	SLT	<input type="checkbox"/> ME87200	SQ	<input type="checkbox"/> ME86100
	PANZ Metal Panels, Solid	600mm x 600mm	FL	<input type="checkbox"/> ME909975				

Channel Panels	HALCYON	150mm x 1200mm	FL	<input type="checkbox"/> ME97572	SL	<input type="checkbox"/> ME97493	SQ	<input type="checkbox"/> ME97479
	MARS	150mm x 1200mm	FLB	<input type="checkbox"/> ME88887	SLT	<input type="checkbox"/> ME86542	SQ	<input type="checkbox"/> ME86325
	MARS High-NRC	150mm x 1200mm	FLB	<input type="checkbox"/> ME86331	SLT	<input type="checkbox"/> ME86442	SQ	<input type="checkbox"/> ME86404
	PANZ Metal Panels, Solid	150mm x 1200mm	FL	<input type="checkbox"/> ME909954				

Step 3. Select Corresponding Grid for Selected Panels

			Qty	Item No.	Qty	Item No.	Qty	Item No.
Suspension Systems	CENTRICITEE DXT	Main Tee		<input type="checkbox"/> MEDXT3600				<input type="checkbox"/> MEDXT3600
		Cross Tee 1	2	<input type="checkbox"/> MEDXT1200			2	<input type="checkbox"/> MEDXT1200
		Cross Tee 2	1	<input type="checkbox"/> MEDXT1200			1	<input type="checkbox"/> MEDXT1200
		Cross Tee 3	2	<input type="checkbox"/> MEDXT600			2	<input type="checkbox"/> MEDXT600
	IDENTITEE DXI	Main Tee		<input type="checkbox"/> MEDXI3600				
		Cross Tee 1	2	<input type="checkbox"/> MEDXI1200				
		Cross Tee 2	1	<input type="checkbox"/> MEDXI1200				
		Cross Tee 3	2	<input type="checkbox"/> MEDXI600				
	DONN DX	Main Tee				<input type="checkbox"/> MEDX3600		<input type="checkbox"/> MEDX3600
		Cross Tee 1			2	<input type="checkbox"/> MEDX1200	2	<input type="checkbox"/> MEDX1200
		Cross Tee 2			1	<input type="checkbox"/> MEDX1200	1	<input type="checkbox"/> MEDX1200
		Cross Tee 3			2	<input type="checkbox"/> MEDX600	2	<input type="checkbox"/> MEDX600

Suspension System Estimator

	Length	m ²	Main Tee Usage Per m ²	Cross Tee 1 Usage Per m ²	Cross Tee 2 Usage Per m ²	Cross Tee 3 Usage Per m ²
System Module	1350mm	1.620	0.833	1.481	0.741	0.741

Note: Multiply the ceiling area (SF) by the Usage Factor (UF). This calculation will determine lineal footage of suspension system components required. Please refer to the front of this catalogue or IC592 for stabilizer bar usage.

Metric Systems











System 130

1200mm Ceiling Module

150mm Channel

1200mm x 600mm Infill Panel

Selector

Channel Width	Ceiling Module	On-Center Channel Spacing	Infill Panels	Panel Edge	Suspension System	
150mm	1200mm	1350mm	HALCYON	1200mm x 600mm	FL 	DXT, DXI, DXF
					SL 	DX
					SQ 	DX
			MARS	1200mm x 600mm	FLB 	DXT, DXI, DXF
					SLT 	DX
					SQ 	DX
			MARS High-NRC	1200mm x 600mm	FLB 	DXT, DXI, DXF
					SLT 	DX
					SQ 	DX
			PANZ Metal Panels, Solid	1200mm x 600mm	FL 	DXT, DXI

Module Layout

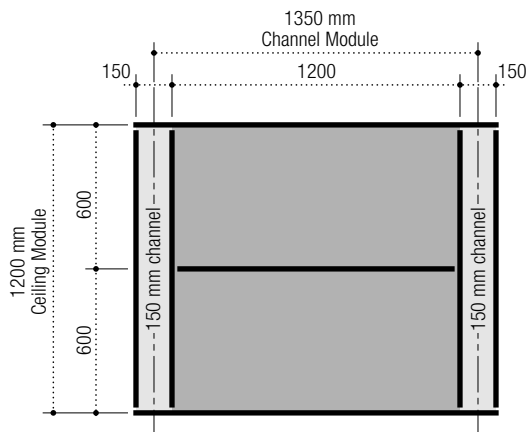

Panel Layout

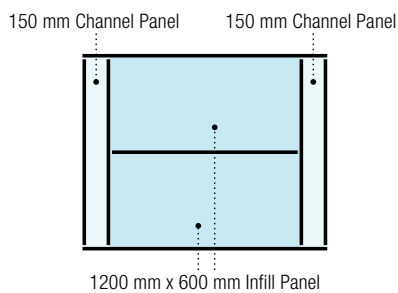

Suspension System Layout

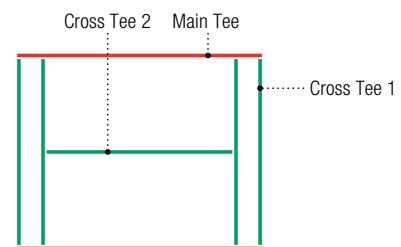

Order Information
System 130

1200mm Ceiling Module

150mm Channel

1200mm x 600mm Infill Panel



Step 1. Select Panels

Step 2. Select Edge for Panels

			FL/FLB		SL/SLT		SQ	
			Edge	Item No.	Edge	Item No.	Edge	Item No.
Infill Panels	HALCYON	1200mm x 600mm	FL	<input type="checkbox"/> ME98245	SL	<input type="checkbox"/> ME98243	SQ	<input type="checkbox"/> ME98241
	MARS	1200mm x 600mm	FLB	<input type="checkbox"/> ME88985	SLT	<input type="checkbox"/> ME88785	SQ	<input type="checkbox"/> ME88185
	MARS High-NRC	1200mm x 600mm	FLB	<input type="checkbox"/> ME89500	SLT	<input type="checkbox"/> ME89600	SQ	<input type="checkbox"/> ME86300
	PANZ Metal Panels, Solid	1200mm x 600mm	FL	<input type="checkbox"/> ME909974				

Channel Panels	HALCYON	150mm x 1200mm	FL	<input type="checkbox"/> ME97572	SL	<input type="checkbox"/> ME97493	SQ	<input type="checkbox"/> ME97479
	MARS	150mm x 1200mm	FLB	<input type="checkbox"/> ME88887	SLT	<input type="checkbox"/> ME86542	SQ	<input type="checkbox"/> ME86325
	MARS High-NRC	150mm x 1200mm	FLB	<input type="checkbox"/> ME86331	SLT	<input type="checkbox"/> ME86442	SQ	<input type="checkbox"/> ME86404
	PANZ Metal Panels, Solid	150mm x 1200mm	FL	<input type="checkbox"/> ME909954				

Step 3. Select Corresponding Grid for Selected Panels

			Qty	Item No.	Qty	Item No.	Qty	Item No.	
Suspension Systems	CENTRICITEE DXT (Use with PANZ)	Main Tee		<input type="checkbox"/> MEDXT3600					
		Cross Tee 1	2	<input type="checkbox"/> MEDXT1200					
		Cross Tee 2	1	<input type="checkbox"/> MEDXT1200					
	IDENTITEE DXI	Main Tee		<input type="checkbox"/> MEDXI3600					
		Cross Tee 1	2	<input type="checkbox"/> MEDXI1200					
		Cross Tee 2	1	<input type="checkbox"/> MEDXI1200					
	DONN DX	Main Tee				<input type="checkbox"/> MEDX3600		<input type="checkbox"/> MEDX3600	
		Cross Tee 1				2	<input type="checkbox"/> MEDX1200	2	<input type="checkbox"/> MEDX1200
		Cross Tee 2				1	<input type="checkbox"/> MEDX1200	1	<input type="checkbox"/> MEDX1200

Suspension System Estimator

	Length	m ²	Main Tee Usage Per m ²	Cross Tee 1 Usage Per m ²	Cross Tee 2 Usage Per m ²	
System Module	1350mm	1.620	0.833	1.481	0.741	



Note: Multiply the ceiling area (SF) by the Usage Factor (UF). This calculation will determine lineal footage of suspension system components required. Please refer to the front of this catalogue or IC592 for stabilizer bar usage.

Metric Systems
System 106

1200mm Ceiling Module

150mm Channel
1200mm x 1200mm Infill Panel

Selector

Channel Width	Ceiling Module	On-Center Channel Spacing	Infill Panels	Panel Edge	Suspension System
150mm	1200mm	1350mm	HALCYON	1200mm x 1200mm	FL  DXT, DXI, DXF
					SL  DX
					SQ  DX

Module Layout

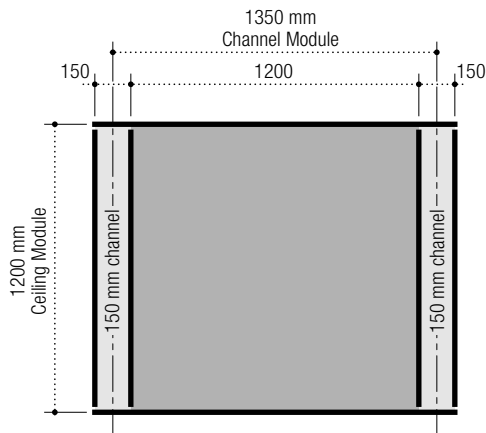

Panel Layout

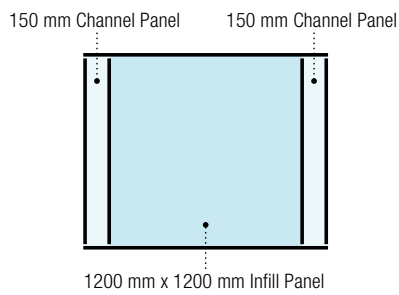

Suspension System Layout

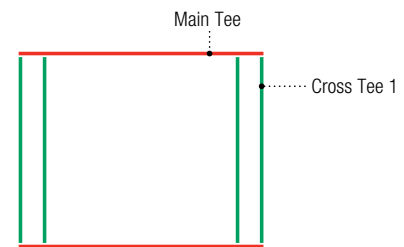

Order Information
System 106

1200mm Ceiling Module

150mm Channel

1200mm x 1200mm Infill Panel



Step 1. Select Panels

Step 2. Select Edge for Panels

			FL/FLB		SL/SLT		SQ	
			Edge	Item No.	Edge	Item No.	Edge	Item No.
Infill Panels	HALCYON	1200mm x 1200mm	FL	<input type="checkbox"/> ME98445	SL	<input type="checkbox"/> ME98443	SQ	<input type="checkbox"/> ME98441

Channel Panels	HALCYON	150mm x 1200mm	FL	<input type="checkbox"/> ME97572	SL	<input type="checkbox"/> ME97493	SQ	<input type="checkbox"/> ME97479
	PANZ Metal Panels, Solid	150mm x 1200mm	FL	<input type="checkbox"/> ME909954				

Step 3. Select Corresponding Grid for Selected Panels

			Qty	Item No.	Qty	Item No.	Qty	Item No.
Suspension Systems	CENTRICITEE DXT	Main Tee		<input type="checkbox"/> MEDXT3600				
		Cross Tee 1	2	<input type="checkbox"/> MEDXT1200				
	IDENTITEE DXI	Main Tee		<input type="checkbox"/> MEDXI3600				
		Cross Tee 1	2	<input type="checkbox"/> MEDXI1200				
	DONN DX	Main Tee				<input type="checkbox"/> MEDX3600		<input type="checkbox"/> MEDX3600
		Cross Tee 1			2	<input type="checkbox"/> MEDX1200	2	<input type="checkbox"/> MEDX1200

Suspension System Estimator

	Length	m ²	Main Tee Usage Per m ²	Cross Tee 1 Usage Per m ²	
System Module	1350mm	1.620	0.833	1.481	

Note: Multiply the ceiling area (SF) by the Usage Factor (UF). This calculation will determine lineal footage of suspension system components required. Please refer to the front of this catalogue or IC592 for stabilizer bar usage.

Metric Systems











System 120

1200mm Ceiling Module

150mm Channel

1800mm x 300mm Infill Panel

Selector

Channel Width	Ceiling Module	On-Center Channel Spacing	Infill Panels	Panel Edge	Suspension System	
150mm	1200mm	1950mm	HALCYON	1800mm x 300mm	FL 	DXT, DXI, DXF
					SL 	DX
					SQ 	DX
			MARS	1800mm x 300mm	FLB 	DXT, DXI, DXF
					SLT 	DX
					SQ 	DX
			MARS High-NRC	1800mm x 300mm	FLB 	DXT, DXI, DXF
					SLT 	DX
					SQ 	DX
			PANZ Metal Panels, Solid	1800mm x 300mm	FL 	DXT, DXI

Module Layout

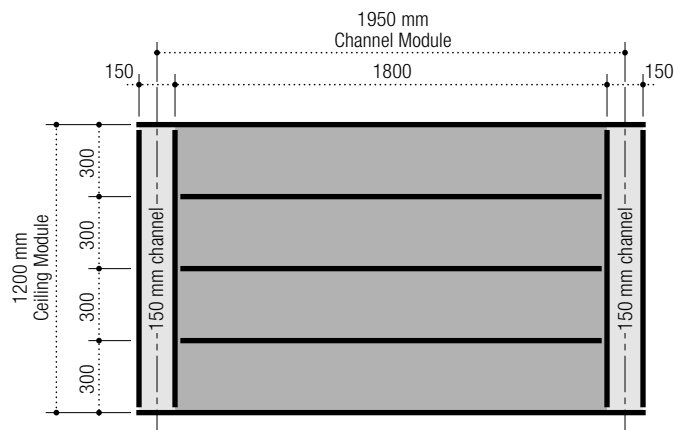

Panel Layout

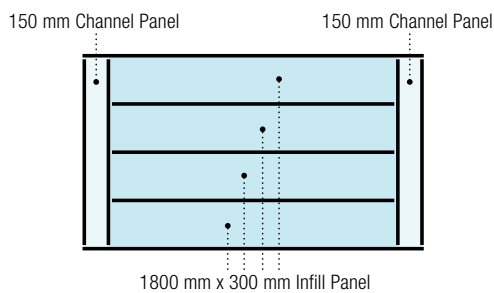

Suspension System Layout

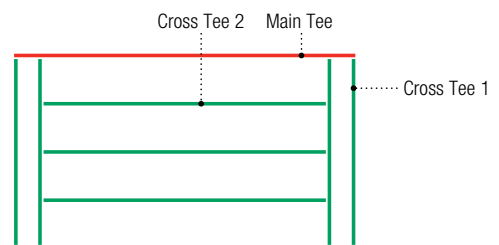

Order Information
System 120

1200mm Ceiling Module

150mm Channel

1800mm x 300mm Infill Panel

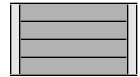

Step 1. Select Panels

Step 2. Select Edge for Panels

			FL/FLB		SL/SLT		SQ	
			Edge	Item No.	Edge	Item No.	Edge	Item No.
Infill Panels	HALCYON	1800mm x 300mm	FL	<input type="checkbox"/> ME97574	SL	<input type="checkbox"/> ME97433	SQ	<input type="checkbox"/> ME97405
	MARS	1800mm x 300mm	FLB	<input type="checkbox"/> ME86570	SLT	<input type="checkbox"/> ME86546	SQ	<input type="checkbox"/> ME86518
	MARS High-NRC	1800mm x 300mm	FLB	<input type="checkbox"/> ME86478	SLT	<input type="checkbox"/> ME86446	SQ	<input type="checkbox"/> ME86409
	PANZ Metal Panels, Solid	1800mm x 300mm	FL	<input type="checkbox"/> ME909956				

Channel Panels	HALCYON	150mm x 1200mm	FL	<input type="checkbox"/> ME97572	SL	<input type="checkbox"/> ME97493	SQ	<input type="checkbox"/> ME97479
	MARS	150mm x 1200mm	FLB	<input type="checkbox"/> ME88887	SLT	<input type="checkbox"/> ME86542	SQ	<input type="checkbox"/> ME86325
	MARS High-NRC	150mm x 1200mm	FLB	<input type="checkbox"/> ME86331	SLT	<input type="checkbox"/> ME86442	SQ	<input type="checkbox"/> ME86404
	PANZ Metal Panels, Solid	150mm x 1200mm	FL	<input type="checkbox"/> ME909954				

Step 3. Select Corresponding Grid for Selected Panels











			Qty	Item No.	Qty	Item No.	Qty	Item No.
Suspension Systems	CENTRICITEE DXT	Main Tee		<input type="checkbox"/> MEDXT3600				
		Cross Tee 1	1	<input type="checkbox"/> MEDXT1200				
		Cross Tee 2	3	<input type="checkbox"/> MEDXT1800				
	IDENTITEE DXI	Main Tee		<input type="checkbox"/> MEDXI3600				
		Cross Tee 1	1	<input type="checkbox"/> MEDXI1200				
		Cross Tee 2	3	<input type="checkbox"/> MEDXI1800				
	DONN DX	Main Tee				<input type="checkbox"/> MEDX3600		<input type="checkbox"/> MEDX3600
		Cross Tee 1			1	<input type="checkbox"/> MEDX1200	1	<input type="checkbox"/> MEDX1200
		Cross Tee 2			3	<input type="checkbox"/> MEDX1800	3	<input type="checkbox"/> MEDX1800

Suspension System Estimator

	Length	m ²	Main Tee Usage Per m ²	Cross Tee 1 Usage Per m ²	Cross Tee 2 Usage Per m ²	
System Module	1950mm	2.340	0.833	0.513	2.308	

Note: Multiply the ceiling area (SF) by the Usage Factor (UF). This calculation will determine lineal footage of suspension system components required. Please refer to the front of this catalogue or IC592 for stabilizer bar usage.

Selector

Channel Width	Ceiling Module	On-Center Channel Spacing	Infill Panels	Panel Edge	Suspension System
150mm	1200mm	1950mm	HALCYON	1800mm x 600mm	FL  DXT, DXI, DXF
					SL  DX
					SQ  DX
			MARS	1800mm x 600mm	FLB  DXT, DXI, DXF
					SLT  DX
					SQ  DX
			MARS High-NRC	1800mm x 600mm	FLB  DXT, DXI, DXF
					SLT  DX
					SQ  DX
			PANZ Metal Panels, Solid	1800mm x 600mm	FL  DXT, DXI

Module Layout

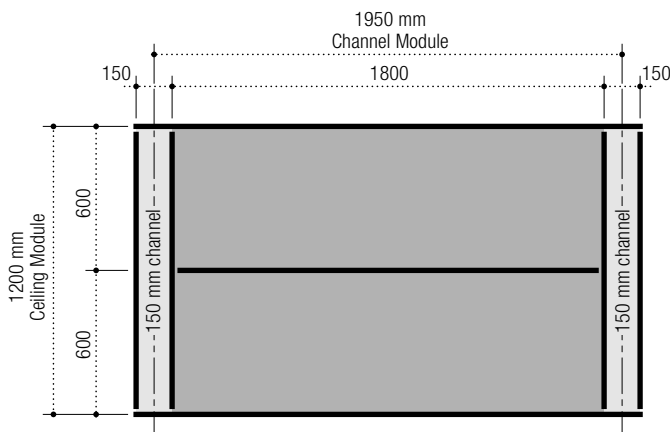

Panel Layout

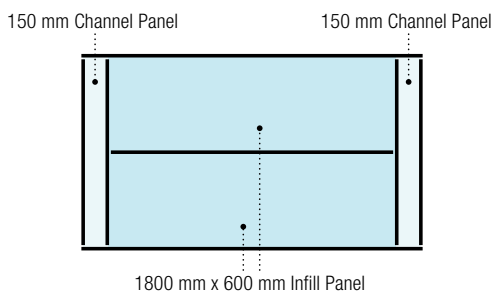

Suspension System Layout

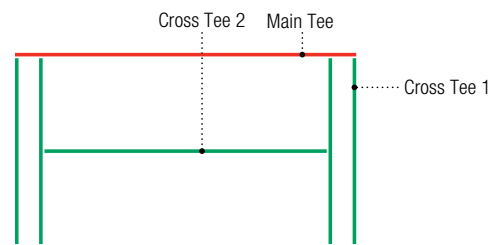



Step 1. Select Panels

Step 2. Select Edge for Panels

			FL/FLB		SL/SLT		SQ	
			Edge	Item No.	Edge	Item No.	Edge	Item No.
Infill Panels	HALCYON	1800mm x 600mm	FL	<input type="checkbox"/> ME97553	SL	<input type="checkbox"/> ME97445	SQ	<input type="checkbox"/> ME99234
	MARS	1800mm x 600mm	FLB	<input type="checkbox"/> ME88996	SLT	<input type="checkbox"/> ME86166	SQ	<input type="checkbox"/> ME86223
	MARS High-NRC	1800mm x 600mm	FLB	<input type="checkbox"/> ME89670	SLT	<input type="checkbox"/> ME89660	SQ	<input type="checkbox"/> ME86360
	PANZ Metal Panels, Solid	1800mm x 600mm	FL	<input type="checkbox"/> ME909970				

Channel Panels	HALCYON	150mm x 1200mm	FL	<input type="checkbox"/> ME97572	SL	<input type="checkbox"/> ME97493	SQ	<input type="checkbox"/> ME97479
	MARS	150mm x 1200mm	FLB	<input type="checkbox"/> ME88887	SLT	<input type="checkbox"/> ME86542	SQ	<input type="checkbox"/> ME86325
	MARS High-NRC	150mm x 1200mm	FLB	<input type="checkbox"/> ME86331	SLT	<input type="checkbox"/> ME86442	SQ	<input type="checkbox"/> ME86404
	PANZ Metal Panels, Solid	150mm x 1200mm	FL	<input type="checkbox"/> ME90954				

Step 3. Select Corresponding Grid for Selected Panels

			Qty	Item No.	Qty	Item No.	Qty	Item No.	
Suspension Systems	CENTRICITEE DXT	Main Tee		<input type="checkbox"/> MEDXT3600					
		Cross Tee 1	2	<input type="checkbox"/> MEDXT1200					
		Cross Tee 2	2	<input type="checkbox"/> MEDXT1800					
	IDENTITEE DXI	Main Tee		<input type="checkbox"/> MEDXI3600					
		Cross Tee 1	2	<input type="checkbox"/> MEDXI1200					
		Cross Tee 2	2	<input type="checkbox"/> MEDXI1800					
	DONN DX	Main Tee				<input type="checkbox"/> MEDX3600		<input type="checkbox"/> MEDX3600	
		Cross Tee 1				2	<input type="checkbox"/> MEDX1200	2	<input type="checkbox"/> MEDX1200
		Cross Tee 2				2	<input type="checkbox"/> MEDX1800	2	<input type="checkbox"/> MEDX1800

Suspension System Estimator

	Length	m ²	Main Tee Usage Per m ²	Cross Tee 1 Usage Per m ²	Cross Tee 2 Usage Per m ²	
System Module	1950mm	2.340	0.833	1.026	1.538	









Note: Multiply the ceiling area (SF) by the Usage Factor (UF). This calculation will determine lineal footage of suspension system components required. Please refer to the front of this catalogue or IC592 for stabilizer bar usage.

Metric Systems
System 114

1500mm Ceiling Module

150mm Channel
1350mm x 500mm Infill Panel

Selector

Channel Width	Ceiling Module	On-Center Channel Spacing	Infill Panels	Panel Edge	Suspension System
150mm	1500mm	1500mm	HALCYON	1350mm x 500mm	FL  DXT, DXI, DXF
					SL  DX
					SQ  DX
			MARS	1350mm x 500mm	FLB  DXT, DXI, DXF
					SLT  DX
					SQ  DX
			MARS High-NRC	1350mm x 500mm	FLB  DXT, DXI, DXF
					SLT  DX
					SQ  DX

Module Layout

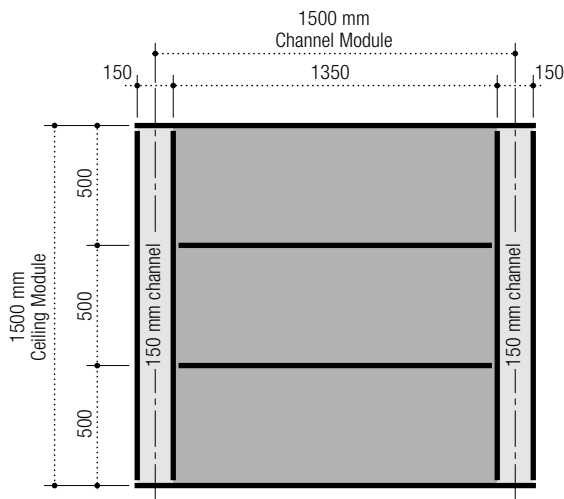

Panel Layout

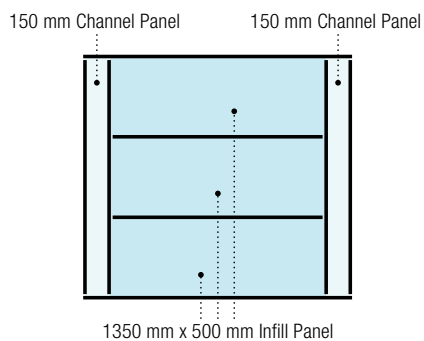

Suspension System Layout

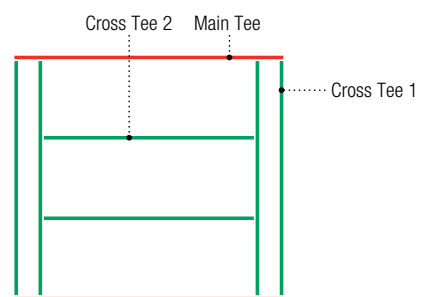

Order Information
System 114

1500mm Ceiling Module

150mm Channel

1350mm x 500mm Infill Panel



Step 1. Select Panels

Step 2. Select Edge for Panels

			FL/FLB		SL/SLT		SQ	
			Edge	Item No.	Edge	Item No.	Edge	Item No.
Infill Panels	HALCYON	1350mm x 500mm	FL	<input type="checkbox"/> ME98360	SL	<input type="checkbox"/> ME97436	SQ	<input type="checkbox"/> ME97407
	MARS	1350mm x 500mm	FLB	<input type="checkbox"/> ME88845	SLT	<input type="checkbox"/> ME86547	SQ	<input type="checkbox"/> ME86519
	MARS High-NRC	1350mm x 500mm	FLB	<input type="checkbox"/> ME86479	SLT	<input type="checkbox"/> ME86447	SQ	<input type="checkbox"/> ME86410
	PANZ Metal Panels, Solid	1350mm x 500mm	FL	<input type="checkbox"/> ME909963				
Channel Panels	HALCYON	150mm x 1500mm	FL	<input type="checkbox"/> ME97573	SL	<input type="checkbox"/> ME97570	SQ	<input type="checkbox"/> ME97490
	MARS	150mm x 1500mm	FLB	<input type="checkbox"/> ME86835	SLT	<input type="checkbox"/> ME86543	SQ	<input type="checkbox"/> ME86507
	MARS High-NRC	150mm x 1500mm	FLB	<input type="checkbox"/> ME86333	SLT	<input type="checkbox"/> ME86443	SQ	<input type="checkbox"/> ME86145

Step 3. Select Corresponding Grid for Selected Panels

			Qty	Item No.	Qty	Item No.	Qty	Item No.
Suspension Systems	CENTRICITEE DXT	Main Tee		<input type="checkbox"/> MEDXT24SP206				
		Cross Tee 1	2	<input type="checkbox"/> MEDXT1500				
		Cross Tee 2	2	<input type="checkbox"/> MEDXT1350				
	IDENTITEE DXI	Main Tee		<input type="checkbox"/> MEDXI24SP206				
		Cross Tee 1	2	<input type="checkbox"/> MEDXI1500				
		Cross Tee 2	2	<input type="checkbox"/> MEDXI1350				
	DONN DX	Main Tee				<input type="checkbox"/> MEDX24SP206		<input type="checkbox"/> MEDX24SP206
		Cross Tee 1			2	<input type="checkbox"/> MEDX1500	2	<input type="checkbox"/> MEDX1500
		Cross Tee 2			2	<input type="checkbox"/> MEDX1350	2	<input type="checkbox"/> MEDX1350

Suspension System Estimator

	Length	m ²	Main Tee Usage Per m ²	Cross Tee 1 Usage Per m ²	Cross Tee 2 Usage Per m ²	
System Module	1500mm	1.500	1.000	2.000	1.800	



Note: Multiply the ceiling area (SF) by the Usage Factor (UF). This calculation will determine lineal footage of suspension system components required. Please refer to the front of this catalogue or IC592 for stabilizer bar usage.

Metric Systems
System 145

1500mm Ceiling Module

150mm Channel
1350mm x 1500mm Infill Panel

Selector

Channel Width	Ceiling Module	On-Center Channel Spacing	Infill Panels	Panel Edge	Suspension System
150mm	1500mm	1500mm	HALCYON 1350mm x 1500mm	FL  SL  SQ 	DXT, DXI, DXF DX DX

Module Layout

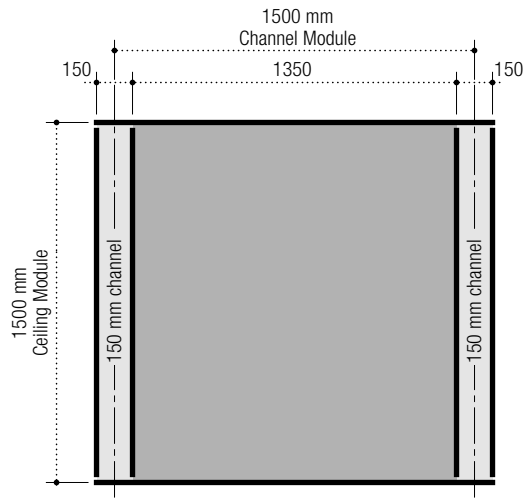

Panel Layout

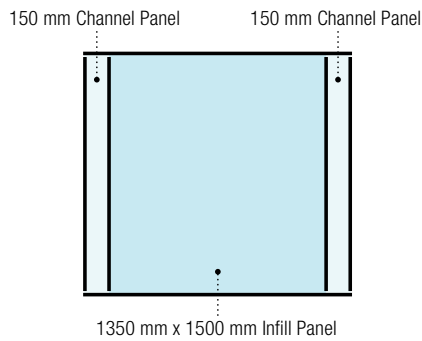

Suspension System Layout

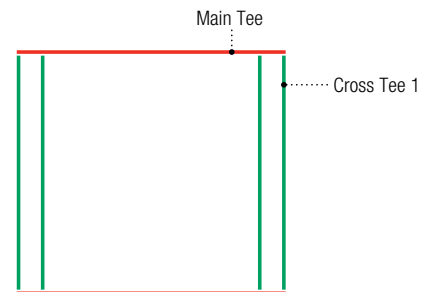

Order Information
System 145

1500mm Ceiling Module

150mm Channel

1350mm x 1500mm Infill Panel

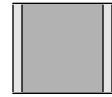

Step 1. Select Panels

Step 2. Select Edge for Panels

			FL/FLB		SL/SLT		SQ	
			Edge	Item No.	Edge	Item No.	Edge	Item No.
Infill Panels	HALCYON	1350mm x 1500mm	FL	<input type="checkbox"/> ME97565	SL	<input type="checkbox"/> ME97536	SQ	<input type="checkbox"/> ME97507

Channel Panels	HALCYON	150mm x 1500mm	FL	<input type="checkbox"/> ME97573	SL	<input type="checkbox"/> ME97570	SQ	<input type="checkbox"/> ME97490
-----------------------	---------	----------------	----	----------------------------------	----	----------------------------------	----	----------------------------------

Step 3. Select Corresponding Grid for Selected Panels

			Qty	Item No.	Qty	Item No.	Qty	Item No.
Suspension Systems	CENTRICITEE DXT	Main Tee		<input type="checkbox"/> MEDXT24SP206				
		Cross Tee 1	2	<input type="checkbox"/> MEDXT1500				
	IDENTITEE DXI	Main Tee		<input type="checkbox"/> MEDXI24SP206				
		Cross Tee 1	2	<input type="checkbox"/> MEDXI1500				
	DONN DX	Main Tee			1	<input type="checkbox"/> MEDX24SP206		<input type="checkbox"/> MEDX24SP206
		Cross Tee 1			2	<input type="checkbox"/> MEDX1500	2	<input type="checkbox"/> MEDX1500

Suspension System Estimator

	Length	m ²	Main Tee Usage Per m ²	Cross Tee 1 Usage Per m ²	
System Module	1500mm	2.250	0.667	1.333	









Note: Multiply the ceiling area (SF) by the Usage Factor (UF). This calculation will determine lineal footage of suspension system components required. Please refer to the front of this catalogue or IC592 for stabilizer bar usage.

Metric Systems
System 143

1500mm Ceiling Module

150mm Channel
675mm x 750mm Infill Panel

Selector

Channel Width	Ceiling Module	On-Center Channel Spacing	Infill Panels	Panel Edge	Suspension System	
150mm	1500mm	1500mm	HALCYON	675mm x 750mm	FL 	DXT, DXI, DXF
					SL 	DX
					SQ 	DX
			MARS	675mm x 750mm	FLB 	DXT, DXI, DXF
					SLT 	DX
					SQ 	DX
			MARS High-NRC	675mm x 750mm	FLB 	DXT, DXI, DXF
					SLT 	DX
					SQ 	DX

Module Layout

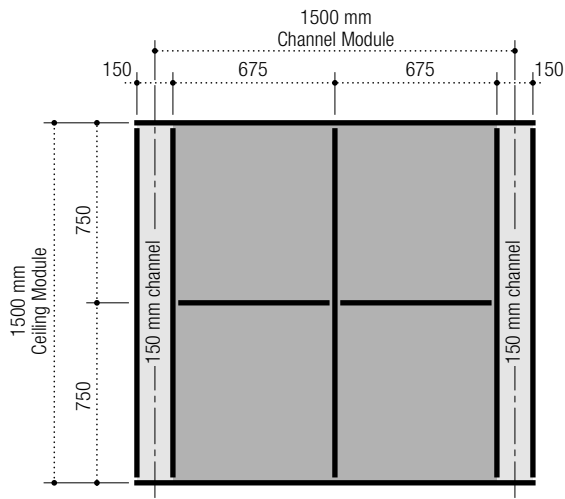

Panel Layout

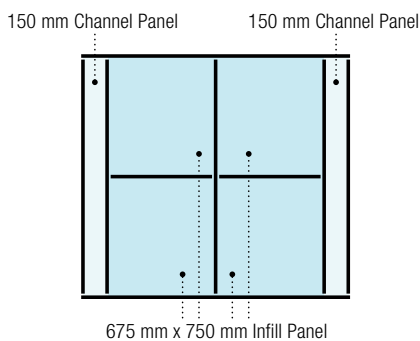

Suspension System Layout

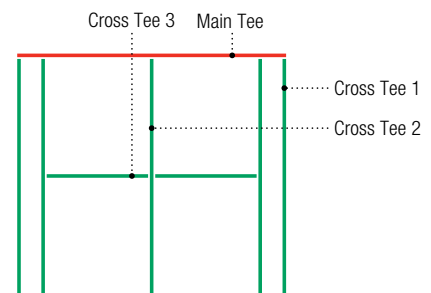

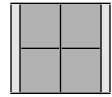

Step 1. Select Panels

Step 2. Select Edge for Panels

			FL/FLB		SL/SLT		SQ	
			Edge	Item No.	Edge	Item No.	Edge	Item No.
Infill Panels	HALCYON	675mm x 750mm	FL	<input type="checkbox"/> ME98333	SL	<input type="checkbox"/> ME97447	SQ	<input type="checkbox"/> ME97417
	MARS	675mm x 750mm	FLB	<input type="checkbox"/> ME86850	SLT	<input type="checkbox"/> ME86557	SQ	<input type="checkbox"/> ME86530
	MARS High-NRC	675mm x 750mm	FLB	<input type="checkbox"/> ME86490	SLT	<input type="checkbox"/> ME86458	SQ	<input type="checkbox"/> ME86421

Channel Panels	HALCYON	150mm x 1500mm	FL	<input type="checkbox"/> ME97573	SL	<input type="checkbox"/> ME97570	SQ	<input type="checkbox"/> ME97490
	MARS	150mm x 1500mm	FLB	<input type="checkbox"/> ME86835	SLT	<input type="checkbox"/> ME86543	SQ	<input type="checkbox"/> ME86507
	MARS High-NRC	150mm x 1500mm	FLB	<input type="checkbox"/> ME86333	SLT	<input type="checkbox"/> ME86443	SQ	<input type="checkbox"/> ME86145

Step 3. Select Corresponding Grid for Selected Panels











			Qty	Item No.	Qty	Item No.	Qty	Item No.
Suspension Systems	CENTRICITEE DXT	Main Tee		<input type="checkbox"/> MEDXT24SP206				
		Cross Tee 1	2	<input type="checkbox"/> MEDXT1500				
		Cross Tee 2	1	<input type="checkbox"/> MEDXT1500				
		Cross Tee 3	2	<input type="checkbox"/> MEDXT675				
	IDENTITEE DXI	Main Tee		<input type="checkbox"/> MEDXI24SP206				
		Cross Tee 1	2	<input type="checkbox"/> MEDXI1500				
		Cross Tee 2	1	<input type="checkbox"/> MEDXI1500				
		Cross Tee 3	2	<input type="checkbox"/> MEDXI675				
	DONN DX	Main Tee				<input type="checkbox"/> MEDX24SP206		<input type="checkbox"/> MEDX24SP206
		Cross Tee 1			2	<input type="checkbox"/> MEDX1500	2	<input type="checkbox"/> MEDX1500
		Cross Tee 2			1	<input type="checkbox"/> MEDX1500	1	<input type="checkbox"/> MEDX1500
		Cross Tee 3			2	<input type="checkbox"/> MEDX675	2	<input type="checkbox"/> MEDX675

Suspension System Estimator

	Length	m ²	Main Tee Usage Per m ²	Cross Tee 1 Usage Per m ²	Cross Tee 2 Usage Per m ²	Cross Tee 3 Usage Per m ²
System Module	1500mm	1.500	1.000	2.000	1.000	0.900

Note: Multiply the ceiling area (SF) by the Usage Factor (UF). This calculation will determine lineal footage of suspension system components required. Please refer to the front of this catalogue or IC592 for stabilizer bar usage.

Selector

Channel Width	Ceiling Module	On-Center Channel Spacing	Infill Panels	Panel Edge	Suspension System
150mm	1500mm	1500mm	HALCYON 1350mm x 750mm	FL 	DXT, DXI, DXF
				SL 	DX
				SQ 	DX
			MARS 1350mm x 750mm	FLB 	DXT, DXI, DXF
				SLT 	DX
				SQ 	DX
			MARS High-NRC 1350mm x 750mm	FLB 	DXT, DXI, DXF
				SLT 	DX
				SQ 	DX
			PANZ Metal Panels, Solid 1350mm x 750mm	FL 	DXT, DXI

Module Layout

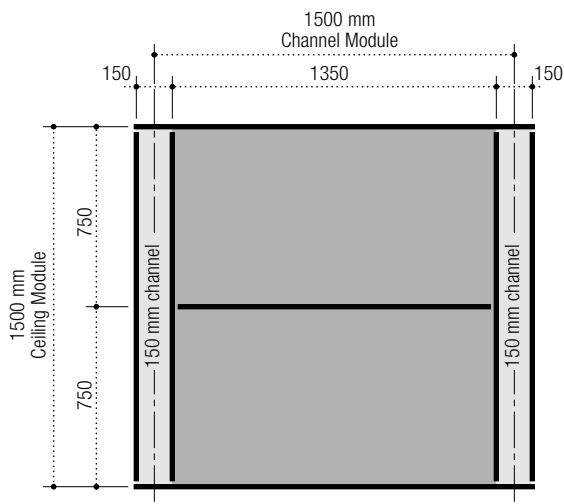

Panel Layout

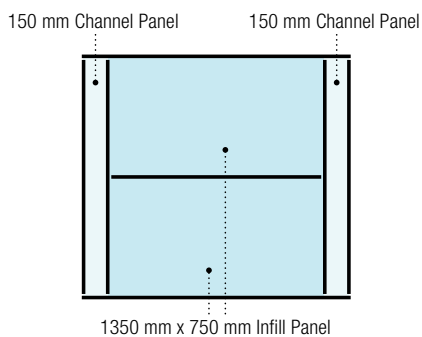

Suspension System Layout

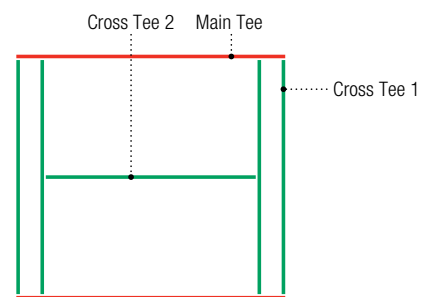

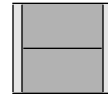

Step 1. Select Panels

Step 2. Select Edge for Panels

			FL/FLB		SL/SLT		SQ	
			Edge	Item No.	Edge	Item No.	Edge	Item No.
Infill Panels	HALCYON	1350mm x 750mm	FL	<input type="checkbox"/> ME98359	SL	<input type="checkbox"/> ME98337	SQ	<input type="checkbox"/> ME97422
	MARS	1350mm x 750mm	FLB	<input type="checkbox"/> ME86831	SLT	<input type="checkbox"/> ME88686	SQ	<input type="checkbox"/> ME86503
	MARS High-NRC	1350mm x 750mm	FLB	<input type="checkbox"/> ME86501	SLT	<input type="checkbox"/> ME86464	SQ	<input type="checkbox"/> ME86427
	PANZ Metal Panels, Solid	1350mm x 750mm	FL	<input type="checkbox"/> ME909972				
Channel Panels	HALCYON	150mm x 1500mm	FL	<input type="checkbox"/> ME97573	SL	<input type="checkbox"/> ME97570	SQ	<input type="checkbox"/> ME97490
	MARS	150mm x 1500mm	FLB	<input type="checkbox"/> ME86835	SLT	<input type="checkbox"/> ME86543	SQ	<input type="checkbox"/> ME86507
	MARS High-NRC	150mm x 1500mm	FLB	<input type="checkbox"/> ME86333	SLT	<input type="checkbox"/> ME86443	SQ	<input type="checkbox"/> ME86145

Step 3. Select Corresponding Grid for Selected Panels

			Qty	Item No.	Qty	Item No.	Qty	Item No.
Suspension Systems	CENTRICITEE DXT	Main Tee		<input type="checkbox"/> MEDXT24SP206				
		Cross Tee 1	2	<input type="checkbox"/> MEDXT1500				
		Cross Tee 2	1	<input type="checkbox"/> MEDXT1350				
	IDENTITEE DXI	Main Tee		<input type="checkbox"/> MEDXI24SP206				
		Cross Tee 1	2	<input type="checkbox"/> MEDXI1500				
		Cross Tee 2	1	<input type="checkbox"/> MEDXI1350				
	DONN DX	Main Tee				<input type="checkbox"/> MEDX24SP206		<input type="checkbox"/> MEDX24SP206
		Cross Tee 1			2	<input type="checkbox"/> MEDX1500	2	<input type="checkbox"/> MEDX1500
		Cross Tee 2			1	<input type="checkbox"/> MEDX1350	1	<input type="checkbox"/> MEDX1350

Suspension System Estimator

	Length	m ²	Main Tee Usage Per m ²	Cross Tee 1 Usage Per m ²	Cross Tee 2 Usage Per m ²	
System Module	1500mm	2.250	0.667	1.333	0.600	

Note: Multiply the ceiling area (SF) by the Usage Factor (UF). This calculation will determine lineal footage of suspension system components required. Please refer to the front of this catalogue or IC592 for stabilizer bar usage.

Notes

Notes

PRODUCT INFORMATION

See usg.com for the most up-to-date product information.

INSTALLATION

Must be installed in compliance with ASTM C636, ASTM E580, CISCA and standard industry practices, within all applicable code requirements. Alternative assemblies and installation methods may be utilized when approved by the Authority Having Jurisdiction. USG recommends checking with the Authority Having Jurisdiction prior to designing and installing a suspended ceiling system.

CODE COMPLIANCE

The information presented is correct to the best of our knowledge at the date of issuance. Because codes continue to evolve, check with a local official prior to designing and installing a ceiling system. Other restrictions and exemptions may apply. This is only intended as a quick installation reference.

**ICC EVALUATION SERVICE, INC.,
REPORT COMPLIANCE**

Suspension systems manufactured by USG Interiors, Inc., have been reviewed and are approved by listing in ICC-Evaluation Service Report ESR-1222. Evaluation Reports are subject to reexamination, revision and possible cancellation. Please refer to usgdesignstudio.com or usg.com for current reports.

L.A. RESEARCH REPORT Compliance Donn brand suspension systems manufactured by USG Interiors, Inc., have been reviewed and are approved by listing in the following L.A. Research Report number: 25764.

NOTICE

We shall not be liable for incidental and consequential damages, directly or indirectly sustained, nor for any loss caused by application of these goods not in accordance with current printed instructions or for other than the intended use. Our liability is expressly limited to replacement of defective goods. Any claim shall be deemed waived unless made in writing to us within thirty (30) days from date it was or reasonably should have been discovered.

SAFETY FIRST!

Follow good safety/industrial hygiene practices during installation. Wear appropriate personal protective equipment. Read MSDS and literature before specification and installation.

WEBSITES

usg.com
seismicceilings.com
sustainableceilings.com
usgdesignstudio.com

TECHNICAL SERVICE

800 USG.4YOU (800 874.4968)

CUSTOMER SERVICE

800 950.3839